



UNIVERSITY OF NAIROBI
SCHOOL OF COMPUTING AND INFORMATICS

**A framework for implementing Internet Quality of
Service in Kenya**

PRESENTED BY

Nicholas Kibaara Riungu
P56/P/8173/2003

SUPERVISOR

Mr. Erick Ayienga

**A project report submitted in partial fulfillment for the award of
Master of Science degree in Information Systems of the University
of Nairobi**

July 2010

i

University of NAIROBI Library



0439166 0

DECLARATION

This project, as presented in this report, is my original work and has not been published or presented for the award of any university degree.



Nicholas Kibaara Riungu

P56/p/8173/2003

24/08/2010

Date

This research report is submitted for examination with my approval as the university supervisor



Mr. Erick Ayienga, Lecturer,
School of Computing and Informatics,
University of Nairobi

30/08/2010

Date

DEDICATION:

My wife, Cynthia

ABSTRACT

The Internet is built on the datagram model, where each individual packet is forwarded independently to its destination. This model has the strength of simplicity and the ability to adapt automatically to changes in network topology. In this model, all packets are given the same forwarding treatment, and no service differentiation is provided.

The growth of the Internet has brought with it several new applications which require some level of resource assurance to operate. These resource assurances cannot be addressed in the traditional datagram model, which has limited resource management capabilities inside the network and therefore cannot provide any resource guarantees to users. The concept of Quality of Service (QoS) was thus introduced in order to provide service differentiation and assurance for these services.

According to ITU, Internet quality of service is the collective effect of service performance which determines the degree of satisfaction on the part of the user of the service [ITU-T, E.800]. It represents those quantitative and qualitative characteristics of a network system that are necessary to achieve the required functionality of an application [Vogel et al, 1995]. These characteristics are specified through service parameters such as bandwidth, jitter, packet loss, and delay.

To support the implementation of QoS capabilities on the Internet, the Internet Community developed two key service models, the differentiated services (Diffserv) and the integrated services (Intserv) models. Diffserv provides QoS capabilities by classifying packets, using the differentiated services code point (DSCP), while Intserv uses RSVP to reserve resources across the network path. In addition, the Intserv over Diffserv was later proposed to provide the benefits of both Diffserv and Intserv end-to-end QoS capabilities.

In Kenya, the Internet was introduced in 1992 [Mweu, 2000], and has seen a tremendous growth, especially in the last ten years. This has seen the introduction of many applications, some of which require resource assurances and service differentiation. However, Internet services in Kenya are still based on the best effort service, to a large extent, with very minimal QoS support provided.

This report presents an overview of the Internet services in Kenya, and proposes a framework which can be used to specify and implement QoS capabilities for Internet Services in Kenya. The framework proposed herein is based on the Intserv over Diffserv service model, as defined by the Internet Engineering Task Force (IETF).

The framework focuses on three service components; infrastructure, user environment and application type. It makes proposals on the minimum infrastructure requirements, as well as the parameter settings that would be suitable in implementing QoS for these types of services.

Three service classes are defined with six associated service types. Each of these service types is targeted towards a specific category of applications, as well as infrastructure capacity.

The framework provides a means by which Internet QoS can be provided, and evaluated.

ACKNOWLEDGEMENT

I wish to acknowledge the support from my supervisor, Mr. Erick Ayienga of the SCI, and all the SCI staff.

I also wish to thank my employer the Kenya Methodist University and particularly my colleague in the department of Computer Information Systems, for their support and encouragement.

Last and not least, I acknowledge the support of my family; my wife, my mum, my brothers and sisters, and all who assisted in one way or another during this period of study.

TABLE OF CONTENTS:

| <u>Content</u> | <u>Page</u> |
|---|-------------|
| Declaration | ii |
| Dedication | iii |
| Abstract | iv |
| Acknowledgement | vi |
| List of figures | ix |
| List of tables | x |
| List of Abbreviations | xi |
| 1. Chapter One: Introduction | |
| 1.1. The Internet | 1 |
| 1.2. Quality of service | 2 |
| 1.3. Problem statement | 4 |
| 1.3.1. Problem definition | 4 |
| 1.3.2. Research hypothesis | 5 |
| 1.4. Research justification | 5 |
| 1.5. Research objectives: | 6 |
| 1.5.1. General objective | 6 |
| 1.5.2. Specific objectives | 6 |
| 1.5.3. Research questions | 6 |
| 2. Chapter Two: Review of relevant literature | |
| 2.1. Internet Quality of Service | 7 |
| 2.2. Quality of Service parameters/ requirements | 8 |
| 2.3. Quality of Service implementation techniques | 9 |
| 2.4. Quos-Sensitive applications | 11 |
| 2.5. End-to-end QoS models | 12 |
| 2.5.1. The best-effort service model | 13 |
| 2.5.2. The Integrated services model | 14 |
| 2.5.3. The differentiated services model | 16 |
| 2.5.4. Intserv over Diffserv model | 19 |
| 2.5.5. Other models | |
| 2.5.5.1. Multi-Protocol Label Switching | 20 |
| 2.5.5.2. The Asynchronous Transfer Mode | 22 |

| | |
|---|----|
| 2.6. Limitations to QoS implementation | 22 |
| 3. Chapter 3: Internet QoS in Kenya | |
| 3.1. Introduction | 25 |
| 3.2. Existing Internet infrastructure in Kenya | 29 |
| 3.3. Service differentiation and Quality of Service | 34 |
| 4. Chapter 4: Conceptual Framework | |
| 4.1. Introduction | 36 |
| 4.2. The Intserv over Diffserv Service model | 37 |
| 5. Chapter 5: Research Methodology | |
| 5.1. Research design | 39 |
| 5.2. Data collection methods | 40 |
| 6. Chapter 5: Data analysis and Results | |
| 6.1. Analysis of corrected data | 42 |
| 6.2. Preliminary Data | 42 |
| 6.3. Data from CCK | 43 |
| 6.4. Data from Internet Users | 46 |
| 6.5. Data from ISPs | 54 |
| 7. Chapter 6: Proposed Framework | |
| 7.1. Introduction | 61 |
| 7.2. Model implementation components | 64 |
| 7.3. The KiQoS Model and Services | 65 |
| 7.4. KiQoS Service implementation | 72 |
| 7.5. Framework Validation | 80 |
| 8. Chapter 7: Conclusion and Recommendations | |
| 8.1. Introduction | 82 |
| 8.2. Conclusion | 82 |
| 8.3. Recommendations | 83 |
| Appendices | |
| Appendix A: References | 84 |
| Appendix B: Cover Letter | 86 |
| Appendix C: Questionnaire 1 | 87 |
| Appendix D: Questionnaire 2 | 93 |

LIST OF FIGURES

| <u>Figure</u> | <u>page</u> |
|----------------------|--------------------|
| Figure 2.1 | 19 |
| Figure 3.1 | 26 |
| Figure 3.2 | 30 |
| Figure 3.3 | 32 |
| Figure 3.4 | 33 |
| Figure 3.5 | 34 |
| Figure 4.1 | 37 |
| Figure 6.1 | 47 |
| Figure 6.2 | 48 |
| Figure 6.3 | 51 |
| Figure 6.4 | 52 |
| Figure 6.5 | 54 |
| Figure 6.6 | 56 |
| Figure 6.7 | 57 |
| Figure 6.8 | 58 |
| Figure 6.9 | 59 |
| Figure 7.2 | 66 |
| Figure 7.3 | 67 |
| Figure 7.4a | 73 |
| Figure 7.4b | 73 |
| Figure 7.5 | 74 |
| Figure 7.6 | 75 |
| Figure 7.7 | 75 |
| Figure 7.8 | 76 |
| Figure 7.9 | 77 |
| Figure 7.10 | 78 |
| Figure 7.11 | 79 |
| Figure 7.12 | 79 |
| Figure 7.13 | 80 |
| Figure 7.14 | 80 |

LIST OF TABLES

| <u>Table</u> | <u>page</u> |
|--------------------|-------------|
| Table 2.1 | 9 |
| Table 3.1 | 31 |
| Table 6.1 | 44 |
| Table 6.2 | 44 |
| Table 6.3 | 45 |
| Table 6.4 | 46 |
| Table 6.5 | 46 |
| Table 6.6 | 47 |
| Table 6.7 | 48 |
| Table 6.8 | 49 |
| Table 6.9 | 49 |
| Table 6.10 | 50 |
| Table 6.11 | 50 |
| Table 6.12 | 51 |
| Table 6.13 | 52 |
| Table 6.14 | 53 |
| Table 6.15 | 53 |
| Table 6.16 | 55 |
| Table 6.17 | 55 |
| Table 6.18 | 56 |
| Table 6.19 | 56 |
| Table 6.20 | 58 |
| Table 6.21 | 58 |
| Table 6.22 | 59 |
| Table 7.1(a) | 68 |
| Table 7.1(b) | 69 |
| Table 7.1(c) | 70 |
| Table 7.2 | 78 |

LIST OF ABBREVIATIONS

1. AF – Assured Forwarding
2. ARCC – Africa Regional Centre for Computing
3. ARPANET – Advanced Research Project Agency Network
4. ATM – Asynchronous Transfer mode
5. CBR – Constant Bit Rate
6. CCK – Communications Commission of Kenya
7. DARPA – Defense Advanced Research project Agency
8. Diffserv – Differentiated Services Architecture
9. DSCP – Differentiated Services Code point
10. EASSy – East Africa Submarine Cable System
11. EF – Expedited Forwarding
12. IETF – Internet Engineering Task Force
13. Intserv – Integrated Services Architecture
14. IP – Internet Protocol
15. ISP – Internet Service provider
16. ITU – International Telecommunication union
17. LSP – Label Switching Protocol
18. MPLS – Multi-Protocol Label Switching
19. NQoS – Network Quality of Service
20. PHB – Per-Hop Behavior
21. QoS – Quality of Service
22. RFC – Request For Comments
23. RSVP – Resource Reservation Protocol
24. SLA – Service Level Agreement
25. SONET – Synchronous Optical Network
26. TEAMS – The East Africa Marine System
27. ToS – Type of Service
28. VBR – Variable Bit Rate
29. VoD – Video on Demand
30. VoIP – Voice Over Internet Protocol
31. VPN – Virtual Private Network

Chapter One: Introduction

1.1. The Internet

The current Internet has its roots in the ARPANET, an experimental data network funded by the United States Defense Advanced Research Projects Agency (DARPA) in the early 1960s. An important goal was to build a robust network that could survive active military attacks such as bombing. To achieve this, the ARPANET was built on the datagram model, where each individual packet is forwarded independently to its destination. The datagram network has the strength of simplicity and the ability to adapt automatically to changes in network topology [Zheng Wang, 2001]. It however, has limited resource management capabilities inside the network and therefore cannot provide any resource guarantees to users. In addition, the Internet treats all packets the same way, thus offering a single level of service for all applications.

For many years, the Internet was primarily used by scientists for networking research and for exchanging information amongst themselves. Remote access, file transfer, and e-mail were among the most popular applications, and for these applications the datagram model works well.

The World Wide Web, however, has fundamentally changed the Internet. New applications, such as video conferencing, Web searching, electronic media, discussion boards, and Internet telephony, have been developed. E-commerce is revolutionizing the way we do business. The Internet is destined to become the ubiquitous global communication infrastructure for the twenty first century [Zeng Wang, 2001].

Since the introduction of the World Wide Web, many new applications have emerged that require some sort of special treatment. These applications require some minimal level of resources to operate, as well as predictability in the performance of the network. These requirements translate into technical constraints for network bandwidth, latency, packet loss and jitter. The ability of a network to offer guarantees on these parameters is referred to a Quality of Service (QoS). Application that need these assurances are said to be QoS sensitive.

As a result of these challenges in the Internet usage, and it becoming indispensable in the homes and work places of the twenty-first century, there is a growing trend for organizations to show willingness to pay a little more, if this guarantees them of preferential treatment or at the least guaranteed levels of service.

In Kenya, the Internet was introduced in 1992 [Mweu, 2000]. It has since expanded to become a core component in business, education, and also in the life of the individual. However, the level of technology, and cost of services, offered by the Internet service providers in Kenya tends to limit the extent to which the Internet can be exploited. The introduction of the undersea fiber optic cables, between 2009 and 2011, is expected to provide a solution to these constraints. It is however not clear how this will affect the cost of services.

According to Waema et al (2007), there is increased use of Quality of Service sensitive applications such as IP-telephony, video conferencing, video on demand, interactive games, E-commerce, etc. Bandwidth provisioning has been widely used to ensure service quality and user satisfaction by Internet service providers. Internet users have also embraced this approach as a solution to poor service quality.

The regulatory framework for the implementation and quality of service for these applications is either absent or in development stages. This present an urgent need for a framework to guide the implementation, so that the quality of service requirements are addressed sufficiently.

1.2. Quality of service

The capability to provide resource assurance and service differentiation in a network is often referred to as quality of service (QoS) [Zeng wang, 2001].

Generally, Quality of Service (QoS) is defined as the collective effect of service performances, which determine the degree of satisfaction on the part of the user of the service [ITU-T recommendation E-800]. This implies that the user is the final arbiter of 'good' or 'bad' QoS.

According to Vogel et al, 1995, QoS represents those quantitative and qualitative characteristics of a network system, that are necessary to achieve the required functionality of an application.

Network Quality of Service (NQoS) is thus defined as a measure of the extent to which a network is capable of providing better service to selected network traffic, over various technologies, to sustain the user's requirements. The implementation of these QoS capabilities in the Internet has been one of the toughest challenges in its evolution, leading to changes in the technology and basic architecture of the Internet.

Different applications demand different service qualities. Some need minimal delay and reliable response time, while others may need a good image quality [X. Guo, 1997]. The need for QoS capabilities in the Internet stems from the fact that best-effort service and datagram routing do not meet the needs of many new applications, which require some degree of resource assurance in order to operate effectively. Diverse customer requirements also create a need for service providers to offer different levels of services in the Internet.

A necessary component in a quality of service-enabled network is the service model. The quality of service model defines the type of services provided, and their quality of service parameters.

In addition, a number of quality of service (QoS) models have been proposed in the recent past [Zeng wang, 2001].

The Internet community has developed a number of new technologies to address these issues. The Integrated Services and Differentiated Services architectures were developed to provide alternative approaches for resource allocation in the Internet. Integrated Services use the resource reservation protocol (RSVP) to provide guaranteed resources for individual flows. The Differentiated Services architecture takes a different approach. It combines edge policing, provisioning, and traffic prioritization to provide different levels of services to customers [Zeng wang, 2001].

Multiprotocol Label Switching (MPLS) [rfc 3812] and traffic engineering [rfc 3272] address the issues of bandwidth provisioning and performance optimization in Internet backbones. The explicit route mechanism in MPLS adds an important

capability to the IP-based network. Combined with constraint-based routing in traffic engineering, MPLS and traffic engineering can help network providers make the best use of available resources and reduce costs [Zeng wang, 2001].

1.3. Problem statement

1.3.1 Problem Definition

The growth of the Internet in Kenya has seen the introduction of a range of multimedia and real-time applications. These applications, including online banking, E-commerce, E-learning, video conferencing, and Voice over Internet Protocol (VoIP), require some form of service assurance. This makes it necessary to provide a way in which the existing network infrastructure can be utilized to provide support for these applications.

The level of technology and infrastructure, between Internet service providers and the application users, has not grown in proportion with the application needs. This is mostly attributed to the ownership and control of the same, since most service providers don't own the infrastructure.

The absence of specific policy framework, touching on Quality of Service for Internet applications, has made it more difficult to determine the acceptable level of service, particularly for these QoS-sensitive applications.

Several Quality of Service models already exist. However, these offer only partial solution to the QoS requirements in Kenya. This is partly because:

- These models are so much dependent on investment in hardware technologies.
- The overall bandwidth available, and shared, between service providers and end users is a limitation. This is expected to improve with the launch of the fiber optic links.
- These models assume a service level/ parameter levels based on good Internet infrastructure.
- Most Internet users in Kenya are "once-in-a-while" users of the real-time applications. This serves as a disincentive to subscribing for QoS capabilities in the network.

- The specification of QoS parameters is quite technical, and not readily understood by most service users in Kenya.
- Cost of Internet services is based on time and fixed bandwidth, thus does not provide for additional bandwidth resources, nor factor in the cost of delay and jitter.

1.3.2 Research Hypothesis

It is possible to achieve Internet QoS in Kenya based on the existing technology and infrastructure.

1.4. Research justification

The Internet situation in Kenya represents a unique set of requirements and implementation options which may not be addressed, fully, by the existing Quality of Service models.

Since it may not be possible to achieve the level of technology and infrastructure identified in the definition of the existing models, it is important to determine how best we can utilize the existing technology and infrastructure, to attain quality internet services. In addition, we need a measure of quality for our Internet services.

Quality of service is only sustainable when it is supported by the service provider, and understood by the service user. The technical aspects involved in the specification and implementation of QoS, makes it difficult to implement sustainable QoS.

This study seeks to propose a framework, for the implementation of Internet quality of service in Kenya, that determines the parameters and level of service at which the service offered is acceptable, especially for the QoS-sensitive applications. It proposes a means of QoS specification that is easily understood by both the user and service provider.

The study, however, does not define new parameters or technological specifications. Instead, it seeks to provide a framework, based on the existing

models and standards that will ease the specification and implementation of Quality of Service.

1.5. Research objectives

1.5.1. General objective

The overall objective of this project is to develop a framework for the implementation of Internet Quality of Service in Kenya.

1.5.2. Specific objectives

To achieve the overall project objective, the following specific objectives will be pursued:

- (a.) To establish if there is, currently, a quality of service measure in the provision of Internet services in Kenya.
- (b.) To determine the applications that currently need guaranteed services in the Kenyan market.
- (c.) To determine whether the existing quality of service models are applicable to the Kenyan scenario.
- (d.) To determine how Internet users in Kenya access the services.
- (e.) To determine the Internet users' understanding of QoS
- (f.) To propose a Quality of Service framework.

1.5.3. Research Questions

The following research questions will guide this study:

- (a.) Is there an existing measure of quality in the provision of Internet services in Kenya?
- (b.) Are the existing quality of service models applicable to the Kenyan situation?

Chapter Two: Review of relevant literature

2.1 Internet Quality of Service

In the traditional Internet, the service differentiation has been in the pricing structure (individual vs. business rates) or the connectivity type (dial-up access vs. leased line, etc) [Y. Bernet et al].

With the expansion of Internet traffic and its diversified service request, the traditional network service model, which provides all the users with the same performance level (best effort service), can no longer meet the users' demand that is essential to a set of differentiated services [S. Voung, et al.]

According to Ruediger Z, et al. [2007], the current model of achieving network quality in public IP networks, which is based on 'Over provisioned best Effort' approach, will not be sufficient to deliver end-to-end premium services to a large user base in an acceptable quality. Its inability to differentiate service classes can be considered inefficient as it results in uncontrolled overload times and requires a network capacity that by far exceeds an optimal capacity, both from an economical and managerial perspective.

Quality of Service (QoS) refers to the capability of a network to provide better service to selected network traffic over various technologies, including Frame Relay, Asynchronous Transfer Mode (ATM), Ethernet and .802.1 networks, SONET, and IP-routed networks that may use any or all of these underlying technologies [Cisco Systems, 2003].

The primary goal of QoS is to provide priority, including dedicated bandwidth, controlled jitter and latency, and improved loss characteristics. Fundamentally, QoS enables you to provide better service to certain flows. This is done by either raising the priority of a flow, or limiting the priority of another flow. Also important is making sure that providing priority for one or more flows does not make other flows fail [Cisco systems, 2003].

QoS comprises a set of techniques to manage network resources in a manner that enables the network to differentiate and handle traffic based on policy. This provides consistent and predictable data delivery to users or applications that are supported within the network. Achieving the required Quality of Service (QoS) by

managing delay, delay variation (jitter), bandwidth, and packet loss parameters on a network becomes the secret to a successful end-to-end business solution.

Apart from over-provisioning network resources, providing QoS guarantees require deployment of appropriate QoS control mechanisms in the operations and management of a network. A vast variety of QoS control mechanisms have been proposed and developed, with varying degree of complexity and cost.

Implementing a successful QoS policy will ensure a predictable, measurable, and guaranteed treatment of the communications on the backbone. This would provide a better means of handling specialized traffic on the limited and costly backbone resources. The demand for the use of bandwidth-intensive and delay/jitter-sensitive applications coupled with the ever-increasing use of backbone for “unsupported” traffic provides the need and reasoning for implementing QoS.

2.2 Quality of Service parameters/ requirements

Network QoS can be defined in a variety of ways and include a diverse set of service requirements, such as performance, availability, reliability, security, etc. All these service requirements are important aspects of a comprehensive network QoS service offering. Typical performance metrics used in defining network QoS are bandwidth, delay/delay jitter, and packet loss rate.

Using these performance metrics, network performance guarantees can be specified in various forms, such as *absolute* (or *deterministic*), e.g., a network connection is guaranteed with 10 Mbps bandwidth all the time; *probabilistic* (or *stochastic*), e.g., network delay is guaranteed to be no more than 100 ms for 95% of the packets; *time average*, e.g., packet loss rate is less than 10^{-5} measured over a month.

The *guarantee* feature of network QoS is what differentiates it from the “best-effort” network services. The exact form of performance guarantee is defined as part of the service level agreement (SLA) between the network service provider and its customers.

The key Network Quality of Service (NQoS) parameters are:

- Reliability or packet loss rates

- Delay
- Delay jitter
- Bandwidth

In addition, network availability and service cost have also been identified as key parameters in the provision of practical end-to-end Internet Quality of Service.

The table below illustrates the degree to which different Internet applications are sensitive to the service parameters.

Table 2.1: Degree to which applications are sensitive to quality parameter

| Application | Reliability | Delay | Jitter | Bandwidth |
|-------------------|-------------|--------|--------|-----------|
| E-mail | High | Low | Low | Low |
| File transfer | High | Low | Low | Medium |
| Web access | High | Medium | Low | Medium |
| Remote login | High | Medium | Medium | Low |
| Audio on demand | Low | Low | High | Medium |
| Video on demand | Low | Low | High | High |
| Telephony | Low | High | High | Low |
| Videoconferencing | Low | High | High | High |

Source: Tannenbaum et al [2004]

2.3 Quality of Service implementation techniques

No single technique provides efficient, dependable quality of service in an optimum way. Instead, a variety of techniques have been developed. These include:

- Over-provisioning,
- Buffering,
- Traffic shaping, and
- Resource reservation.

According to Tannenbaum et al, [2004] Practical solutions often involve a combination of several of these techniques.

Over-provisioning

This involves the provision of so much router capacity, buffer space, and bandwidth, that the packets fly through the network easily. The technique seeks to provide a constant, high capacity stream service, in response to the bandwidth, delay, jitter and reliability needs of data streams.

The technique is however expensive to implement, as it requires the investment in additional equipment.

Buffering

Buffering increases delay, and smoothes jitter, by temporarily storing packets on intermediate nodes. This allows the implementation of a controlled transmission rate from one point to the next.

Buffering has no effect on reliability or bandwidth. It is thus a technique suitable for flows that are tolerant to delay, but sensitive to jitter, such as audio and video on demand.

Traffic shaping

Buffering does not work for some applications. E.g. Video Conferencing.

Traffic shaping involves the smoothing of the transmission rate, or packet delivery rate, by providing a uniform traffic flow. It involves the regulation of the average rate, and burst, of a transmission.

In traffic shaping, the user and the subnet agree on a certain traffic pattern, for that circuit, during connection set up. This agreement is called a **Service Level Agreement (SLA)**. Traffic shaping is more important for real-time data, such as audio and video connections, which have stringent quality of service requirements.

Resource Reservation

The implementation of traffic shaping on datagram subnets assumes that all the packets of a flow follow the same route. However, packet switched networks send packets independently, through different routers, making it hard to guarantee much through traffic shaping.

Resource reservation sets up a virtual circuit from the source, to destination, and all packets that belong to the flow must follow this route.

Once a route for a flow has been specified, it becomes possible to reserve resources along that route, making sure that the necessary capacity for the flow is available.

Three different kinds of resources can be reserved. These are:

- Bandwidth
- Buffer space
- CPU cycles (processing power)

The set of flow parameters need to be specified accurately. These can be negotiated between the sender, receiver, and the intermediate routers.

Admission Control

Admission control mechanisms are employed to ensure adherence to flow specifications. A router accepts to handle a flow only if there are sufficient resources to service the flow, otherwise the request is turned down.

According to O'Neil [2002], admission control combines bandwidth control and policy control to provide network quality of service (NQoS). In a typical scenario, applications, such as polycom video communication terminals, request a particular NQoS for their traffic.

The devices in the network, through which this traffic passes, can either grant or deny the request, depending on various factors, such as capacity, load, policies, and so on. If the request is granted, the application has a contract for the service. The contract is honored as long as there are no disruptive events, such as network outages.

2.4 QoS-sensitive Internet applications

There are likely two major drivers for network services with QoS guarantees:

One comes from applications with *stringent* QoS requirements. Applications such as IP telephony and video-on-demand (VoD) provide strict demands on the service offered over the Internet. In IP telephony two end users send packetized voice and the quality of rendered sound depends on low delay and small loss rate of end-end packet transmission. Likewise, streaming videos over the Internet

requires adequate bandwidth and packet loss guarantees from the network to ensure TV-broadcast quality.

The other major driver for network QoS is the need for *service differentiation* due to competitive nature of the marketplace. A network service provider may support a “virtual private network” (VPN) service over its network with only security guarantee but no performance guarantee. Whereas, another network service provider may support a “virtual leased line” service over its network that, in addition to security guarantee, has bandwidth, delay and loss guarantees comparable to a physical leased line. The first network service provider may be forced to enhance its VPN service also with performance guarantees or to lose its customers who demand performance guarantees to its competitor. Hence guaranteed QoS performance can serve as a service differentiating feature for network services.

Real-time applications such as video conferencing are sensitive to the timeliness of data and so do not work well in the Internet, where the latency is typically unpredictable. The stringent delay and jitter requirements of these applications require a new type of service that can provide some level of resource assurance to the applications.

The following applications have been identified to have strict QoS requirements:

- Videoconferencing
- Distance Education
- Video surveillance
- Multimedia Information Retrieval
- Multimedia Desktop Collaboration
- High-definition TV
- Video-on-demand

2.5 End-to-end Quality of Service models

The problem of Internet QoS provisioning has been an active area of research for many years. From the earlier Integrated Services (Intserv) architecture to the more recent Differentiated Services (Diffserv) architecture, many QoS control

mechanisms, especially in the areas of packet scheduling and queue management algorithms, have been proposed.

Elegant theories such as network calculus and effective bandwidths [Chengzhi et al, 2003] have also been developed.

A key component in the provision of Network QoS is a service model. This defines the service levels and parameters involved in the provision of the service [Diederich J. et al, 2005].

End-to-end service models define the actual end-to-end QoS capabilities for a network. The services provided differ in their level of QoS strictness, which describes how tightly the service can be bound by specific bandwidth, delay, jitter, and loss characteristics.

Three basic end-to-end QoS models have been identified for heterogeneous networks. These are:

- The best-effort service model
- The differentiated service model
- The integrated service model

Three factors have been identified as influencing the decision on which service model to deploy in the network. They are:

- The application or problem that a customer wants to solve.
- The rate at which customers can realistically upgrade their infrastructure.
- The cost of implementing and deploying the service.

2.5.1 The best-effort service model

Best-effort service is also referred to as lack of QoS capabilities in a network. It provides the basic connectivity with no guarantees. The service is characterized by FIFO queues, which have no differentiation between traffic flows.

Currently the Internet offers a point-to-point delivery service, which is based on the "best effort" delivery model. In this model, data will be delivered to its destination as soon as possible, but with no commitment as to bandwidth or latency. Using protocols such as TCP, the highest guarantee the network provides is reliable data delivery. This is adequate for traditional data applications like FTP

and Telnet, but inadequate for applications requiring *timeliness*. For example, distributed multimedia applications need to communicate in real-time and are sensitive to the quality of service they receive from the network.

2.5.2 The Integrated services model

The Integrated Services (Intserv) Architecture was originated by the end-to-end research group, of the Internet Engineering Task Force (IETF), in 1991 and 1992. It is a multiple service model that can accommodate multiple QoS requirements.

In this model, an application requests a specific kind of service from the network, before sending data. The request is made by explicit signaling; the application informs the network of its traffic profile and requests a particular kind of service that can encompass its bandwidth and delay requirements. The application is expected to send data only after it gets a confirmation from the network. It is also expected to send data that lies within the profile described during the signaling.

To achieve the requested service, the network maintains per-flow state information, and performs packet classification, policing, and intelligent queuing based on the state. It also performs admission control, based on the information provided by the application, and the available network resource. The network implicitly commits itself to meet the QoS requirements for a given application as long as the traffic remains within the profile specifications..

The Integrated Services architecture, with RSVP, is based on per-flow resource reservation. To receive resource assurance, an application must make a reservation before it can transmit traffic over the network.

Resource reservation involves the following:

- The application characterizes its traffic source and the resource requirements.
- The network then uses a routing protocol to find a path, based on the requested resources.
- A reservation protocol is used to install the reservation state along that path.
- At each hop admission control checks whether sufficient resources are available to accept the new reservation.

- Once the reservation is established, the application can start to send traffic over the path for which it has exclusive use of the resources.
- Resource reservation is enforced by packet classification and scheduling mechanisms in the network elements, such as routers.

The Integrated Services working group proposed the Internet Integrated Services (IIS) with two new services, that a user can select:

- The guaranteed service and
- The controlled load service

The guaranteed service focuses on network delay requirements, and seeks to provide a deterministic worst-case delay bound service, through strict admission control and fair queuing scheduling. It allows applications to reserve bandwidth to meet their requirements. This service was designed for applications that require a perfectly reliable upper-bound on network delay.

The guaranteed service ensures that packets arrive before the requested maximum delay time, and they are not dropped due to network congestion.

The controlled load service focuses more on bandwidth. It provides a less firm guarantee, by providing a service that is close to a lightly loaded best-effort network. It allows applications to have low delay and high throughput even during times of congestion. This service is intended for applications that work well with a non-congested internetwork, providing best-effort service.

Under the controlled load service, there is no delay bound or any other guarantees. The provided service is minimalistic on purpose.

The Resource Reservation Protocol (RSVP) was also standardized for signaling an application's requirements to the network and for setting up resource reservation along the path.

The Integrated Services model was the first attempt to enhance the Internet with QoS capabilities. The research and development efforts provided valuable insights into the complex issues of supporting QoS in the Internet. The resource allocation architecture, new service models, and RSVP protocol were standardized in the late 1990s.

The Integrated services model suffers from scaling and settlement problems. As a result, the deployment of the Integrated Services architecture in the service provider's backbones has been rather slow.

The Integrated Services architecture is however a viable framework for resource allocation in corporate networks. This is because corporate networks are typically limited in size and operated by a single administrative domain. Therefore many of the scaling and settlement issues may not arise. It can support guaranteed bandwidth for IP telephony, video conferencing over corporate intranets. RSVP can also be used for resources allocation and admission control for traffic going out to wide-area networks.

The ideas, concepts, and mechanisms developed in Integrated Services also found their ways into later work on QoS. For example, controlled load service has influenced the development of Differentiated Services, and similar resource reservation capability has been incorporated into MPLS for bandwidth guarantees over traffic trunks in the backbones.

2.5.3 The differentiated services model

According to Zheng Wang [2001], the Differentiated Services architecture was developed as an alternative resource allocation scheme for service providers' networks. By mid-1997 service providers felt that Integrated Services were not ready for large-scale deployment, and at the same time the need for an enhanced service model had become more urgent. The Internet community started to look for a simpler and more scalable approach to offer a better than best-effort service.

After a great deal of discussion, the IETF formed a new working group to develop a framework and standards for allocating different levels of services in the Internet. The new approach, called Differentiated Services, is significantly different from Integrated Services. Instead of making per-flow reservations, Differentiated Services architecture uses a combination of edge policing, provisioning, and traffic prioritization to make possible service differentiation.

In the Differentiated Services architecture, users' traffic is divided into a small number of forwarding classes. For each forwarding class, the amount of traffic that users can inject into the network is limited at the edge of the network. By

changing the total amount of traffic allowed in the network, service providers can adjust the level of resource provisioning and hence control the degree of resource assurance to the users.

The edge of a Differentiated Services network is responsible for mapping packets to their appropriate forwarding classes. This packet classification is typically done based on the service level agreement (SLA) between the user and its service provider. The nodes at the edge of the network also perform traffic policing to protect the network from misbehaving traffic sources. Nonconforming traffic may be dropped, delayed, or marked with a different forwarding class. The forwarding class is directly encoded into the packet header. After packets are marked with their forwarding classes at the edge of the network, the interior nodes of the network can use this information to differentiate the treatment of the packets. The forwarding classes may indicate drop priority or resource priority. For example, when a link is congested, the network will drop packets with the highest drop priority first.

Differentiated Services do not require resource reservation setup. The allocation of forwarding classes is typically specified as part of the SLA between the customer and its service provider, and the forwarding classes apply to traffic aggregates rather than to individual flows. These features work well with transaction-orientated Web applications. The Differentiated Services architecture also eliminates many of the scalability concerns with Integrated Services. The functions that interior nodes have to perform to support Differentiated Services are relatively simple. The complex process of classification is needed only at the edge of the network, where traffic rates are typically much lower.

The Differentiated Services approach relies on provisioning to provide resource assurance. The quality of the assurance depends on how provisioning is carried out and how the resources are managed in the network.

The differentiated services (DiffServ) architecture consists of two main components;

1. Packet marking using the IPv4 ToS byte.
2. Per-Hop-Behaviors (PHBs)

Packet marking is achieved through the IPv4 ToS byte. Diffserv has however completely redefined the ToS byte; It uses six bits to classify packets, and the field is now called the differentiated services (DS) field, with two of the bits unused (RFC-2474). The six bits now replace the three IP-precedence bits, and is referred to as the Differentiated Services Codepoint (DSCP). All classification and QoS in the Diffserv model revolve around the DSCP. With DSCP in any given node, up to 64 aggregates or classes can be supported.

Once network traffic has been marked using the DSCP, the packets are grouped into Behavior Aggregates (BA), at each node. A BA is a collection of packets that have the same DSCP value in them, and crossing in a particular direction.

Per-Hop-Behavior (PHB) is defined as the externally observable forwarding behavior of a node on any packet belonging to a BA (RFC-2475). It refers to the packet scheduling, queuing, policing, or shaping behavior of a node, on any packet belonging to a BA.

The Diffserv define four standard PHBs for constructing a Diffserv-enabled network, and achieve coarse-grained, end-to-end CoS and QoS, these are:

1. The Default PHB (RFC-2474)
2. The Class-Selector PHBs (RFC-2474)
3. Expedited Forwarding PHB (RFC-2598)
4. Assured Forwarding PHB (RFC-2597)

The *default PHB* applies for packets whose DSCP is all zeros, or no DSCP values are set. These packets receive the traditional best-effort service.

The *class-selector PHBs* provide for backward compatibility between DSCP and IP-precedence marked packets. They provide the same service as define in IP-precedence for packets with DSCP value xxx000, where x is either 0 or 1.

The *Expedited Forwarding (EF) PHB* provides for guaranteed bandwidth. It is a key ingredient in Diffserv for the provision of low-loss, low-latency, and assured bandwidth service. EF PHB is especially suitable for applications that require very low packet loss, guaranteed bandwidth, low delay and low jitter.

The *Assured Forwarding (AF) PHB* defines a method by which BAs can be given different forwarding assurances. It defines four AF classes with different amounts

of buffer space, and interface bandwidth. In addition, three drop precedence levels are specified for each AF class.

The Diffserv architecture defines two new services:

1. The premium service
2. The assured service

The premium service uses the Expedited Forwarding (EF) PHB to provide an absolute service differentiation. It creates a “Virtual Leased Line”. Premium service provides a service of low latency, low loss and assured bandwidth.

The assured service uses the Assured Forwarding (AF) PHB to provide a relative service differentiation. It provides different levels of best effort service at the time of network congestion.

2.5.4 Intserv over Diffserv

According to Gerald Bos [2007], the concepts in both Intserv and Diffserv can be combined. The result of this combination is the Intserv over Diffserv model. The model provides an end-to-end quantitative QoS by applying the Intserv model across a network with one or more Diffserv regions. Figure 2.1 illustrates the components of the Intserv over Diffserv Model.

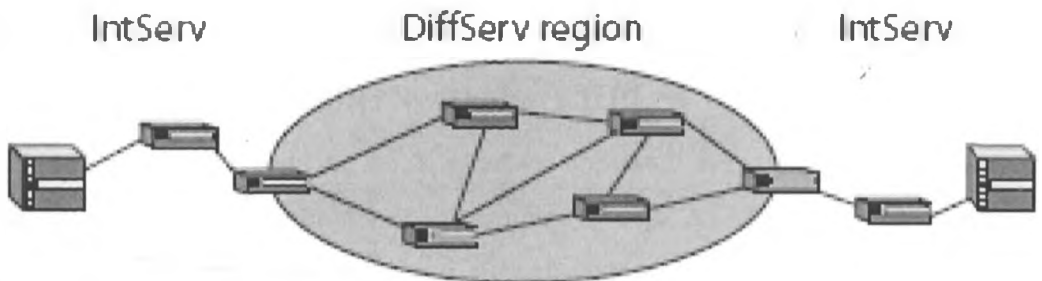

Figure 2.1: Intserv over Diffserv model

In this approach, Diffserv regions do not need to participate in the end-to-end RSVP signaling. The Diffserv parts of the network are treated as links connecting Intserv capable routers. The traffic traversing over the Diffserv network might be limited at the edge of the Diffserv region. Thus the Diffserv regions of the network should be able to support the Intserv style services requested.

To support Intserv, the sender and receiver host must both support an Intserv signalling protocol (e.g. RSVP). The nodes in the Diffserv regions do not need to support RSVP signalling messages, but they do need to be able to forward them.

The requests for the Intserv service types must be mapped onto the capabilities of the Diffserv network. This involves the selection of an appropriate PHB or set of PHBs, performing policing if needed, exporting the Intserv parameters from the Diffserv region and performing admission control on the Intserv requests, taking the available resources in account. When the PHB for the flow is selected, it is then necessary to communicate the choice of DSCP for the flow to other network elements. This is done by mapping. There are two mapping methods, the first one is *default mapping*, where there is a one to one translation from Intserv service types to a specific DSCP. The second method is *Network driven mapping*. In this method, RSVP aware routers in the Diffserv network may override the default mapping. If this happens, the modification needs to be communicated upstream to the marking device.

The KiQoS model, services, and their implementation, specified later in this report, are based on the Intserv over Diffserv implementation model. Default mapping is employed for simplicity of implementation.

2.5.5 Other Models

2.5.5.1 Multi-Protocol Label Switching (MPLS)

MPLS was originally seen as an alternative approach for supporting IP over ATM. Although several approaches for running IP over ATM were standardized, most of the techniques are complex and have scaling problems. The need for more seamless IP/ATM integration led to the development of MPLS in 1997. The MPLS approach allows IP routing protocols to take direct control over ATM switches, and thus the IP control plane can be tightly integrated with the rest of the IP network.

The technique that MPLS uses is known as label switching. A short, fixed-length label is encoded into the packet header and used for packet forwarding. When a label switch router (LSR) receives a labeled packet, it uses the incoming label in

the packet header to find the next hop and the corresponding outgoing label. With label switching, the path that a packet traverses through, called the label switched path (LSP), has to be set up before it can be used for label switching.

In addition to improving IP/ATM integration, MPLS may also be used to simplify packet forwarding.

The driving force behind the wide deployment of MPLS has been the need for traffic engineering in Internet backbones. Internet traffic engineering is defined as that aspect of Internet network engineering dealing with the issue of performance evaluation and performance optimization of operational IP networks. Traffic Engineering encompasses the application of technology and scientific principles to the measurement, characterization, modeling, and control of Internet traffic [RFC-2702, AWD2]. The explicit route mechanism in MPLS provides a critical capability that is currently lacking in the IP-based networks. MPLS also incorporates concepts and features from both Integrated Services and Differentiated Services. For example, MPLS allows bandwidth reservation to be specified over a LSP, and packets can be marked to indicate their loss priority. These features make MPLS an ideal mechanism for implementing traffic-engineering capabilities in the Internet.

MPLS seeks to enhance the services provided in IP-based networks by offering scope for traffic engineering, guaranteed QoS, and virtual private networks (VPNs). It works alongside the existing routing technologies and provides IP networks with a mechanism for explicit control over routing paths. It also allows two fundamentally different data-networking approaches, datagram and virtual circuit, to be combined in IP-based networks. The datagram approach, on which the Internet is based, forwards packets hop by hop based on their destination addresses. The virtual circuit approach, used in ATM and frame relay, requires connections to be set up. With MPLS, the two approaches can be tightly integrated to offer the best combination of scalability and manageability.

MPLS control protocols are based on IP addressing and transport and therefore can be more easily integrated with other IP control protocols. This creates a unified IP-based architecture in which MPLS is used in the core for traffic

engineering and IP routing for scalable domain routing. MPLS is projected to become the standard signaling protocol for the Internet.

2.5.5.2 The Asynchronous Transfer Mode (ATM) Service Model

ATM is a connection-oriented technology which uses virtual circuits to establish connections. The primary purpose of ATM is to provide high-speed, low-delay transport of multiple traffic types.

The ATM Forum defines five service categories:

- *Constant Bit Rate (CBR)* for applications such as Internet telephony.
- *Real-Time Variable Bit Rate (rt-VBR)* for applications such as videoconferencing.
- *Non-Real Time Variable Bit Rate (nrt-VBR)*, for response time critical transaction processing. e.g. airline reservation, banking, etc.
- *Unspecified Bit Rate (UBR)* for non-real-time applications, eg. email, file transfer, etc.
- *Available Bit Rate (ABR)*, any UBR application for which the end-system requires a guaranteed quality of service (QoS). E.g. critical data transfer such as defense information.

In ATM, data transfer is preceded by the establishment of a connection between two end-systems. For each direction of an ATM connection, a specific QoS is negotiated among the networks and end-systems. The network agrees to meet or exceed the negotiated QoS as long as the end-system complies with a negotiated *traffic contract*. A traffic contract comprises a QoS class, a list of traffic parameters and a conformance definition.

2.6 Limitations to QoS implementation

The implementation of NQoS over the Internet has several limitations. One, QoS as found on any consumer router running on a standard Internet Service Provider will only work on upstream/outbound data (data going from you to your ISP). It is practically impossible for a service user to control the priority of data coming

from the ISP, since it's only possible to control the data on your side of the network.

Two, the deployment of the Integrated Services architecture in the service provider's backbones has the following several limitations:

- The Integrated Services architecture focused primarily on long-lasting and delay-sensitive applications. The World Wide Web, however, significantly changed the Internet landscape. Web-based applications now dominate the Internet, and much of Web traffic is short-lived transactions.
- Although per-flow reservation makes sense for long-lasting sessions, such as video conferencing, it is not appropriate for Web traffic.
- The overheads for setting up a reservation for each session are simply too high.
- Concerns also arose about the scalability of the mechanisms for supporting Integrated Services. To support per-flow reservation, each node in a network has to implement per-flow classification and scheduling. These mechanisms may not be able to cope with a very large number of flows at high speeds.
- Resource reservation requires the support of accounting and settlement between different service providers. Since those who request reservation have to pay for the services, any reservations must be authorized, authenticated, and accounted. Such supporting infrastructures simply do not exist in the Internet.
- When multiple service providers are involved in a reservation, they have to agree on the charges for carrying traffic from other service providers' customers and settle these charges among them.
- Most network service providers are normally connected through bilateral peering agreements. To extend these bilateral agreements to an Internet-wide settlement agreement is difficult given the large number of players.

The differentiated services model (Diffserv.), though simple and scalable, lacks mechanisms for admission control. This makes it possible for an application request for resources that may not be available at that moment. The application, in this case, is not aware of the actual service that the network device provided. The application must therefore observe its own end-to-end performance to adapt to the service it is actually receiving from the network device.

The provision of QoS over the Internet involves a substantial cost on the part of the service provider. However, there is no standard framework for determining the actual increase in cost/byte when QoS is introduced. Service providers have to balance between maintaining their profit margin, and remaining in business.

QoS provision is based on the service level specifications as laid down, between the user and service provider, in the SLA. However, majority of network users either are not aware of their actual service requirements, or do not have the required expertise to specify the service levels. On the other hand, service providers provide ready made service packages to users, without option of modification. The user is then restricted to a predefined service type and level, that has different service implications on a user by user basis.

Infrastructure ownership on the Internet is a key limitation to QoS implementation. Due to cost of investment and lease of equipment, most service providers prefer offering services on the already existing national telecommunication grade. In addition, there is a strict limitation on how much of the infrastructure capacity can be assigned to a single provider. To overcome the cost implications, the service providers end up oversubscribing the service. Another alternative has been the use of points-of-presence to provide the services. This provides a bottleneck due to the additional store-and-forward operations at the PoP.

The resources shared on the Internet are finite. This means that every time an application reserves a given resource, it affects the performance of other applications that were sharing the resources. A typical case of bandwidth reservation will disadvantage the applications that are deemed not to be sensitive to QoS requirements.

Chapter 3: Internet Quality of Service in Kenya

3.1 Introduction

The Internet was introduced in Kenya in the early 1990s. By 1992, only e-mail services were available. As with many other African states, Internet development in Kenya was primarily led by a small group of technical enthusiasts, who included Kenyans returning from overseas studies, Western ex-patriots, and Inter-Governmental Organization (IGO) employees, and Non-Governmental Organization (NGO) personnel. Individuals in these groups had been exposed to Internet services and so upon their return or arrival in Kenya demanded Internet access. The only means of accessing the Internet, during this period, was through a Gopher service which offered access to text based information. The access then was through either international leased lines or through X.25 connection to ITUs TIES (Mweu, 2000).

The African Regional Centre for Computing (ARCC), an NGO based in Nairobi, Kenya, was the first provider of web-based Internet service (Mweu, 2000). This they did by providing their subscribers with the first-ever web browser software-Mosaic. The connection to the global Internet backbone was via an analogue leased line.

NGOs and IGOs who were in need of establishing communication with their counterparts elsewhere were among the early adopters of Internet. These also included services offered by HealthNet, email services for the staff of Institute of Computer Science at the University of Nairobi, as well as ARCC email services based on dialup connection to FIDOnet [Waema et al, 2007].

In October 1995, ARCC established the first full Internet services connection in Kenya. Soon after (1995-1996) a number of commercial ISPs led by FormNet and Africa Online entered the market with an array of dial-up access and leased circuits offerings. This was followed by the entry of three other ISPs.

The commercial operators leased analogue and/or digital data links to the USA to access the Internet backbone. Local dedicated lines were predominantly analogue lines leased ranging in capacity from 28.8 Kbps to 64Kbps.

The Kenya Posts & Telecommunication Corporation (KPTC) was the sole provider of telecommunication infrastructure within the country as well as international circuits. The corporation also carried out regulatory functions which included licensing of entrants (ISPs), frequency spectrum management, etc. This made it difficult for the commercial services providers to operate freely without some hindrances from the incumbent who did not have capacity to regulate as well as enter the market as a player. The need for an Internet backbone access locally became eminent with the increased demand for bandwidth and in December 1998, KPTC launched the East Africa Internet eXchange (EAFIX) together with it Jambonet (Mweu, 2000). This led to lowering of costs for ISP operations and an increase in the number of ISPs active in the market. Competition resulted in slightly better prices for the end users.

The international bandwidth available at EAFIX comprised of 3 routes as follows:

- Teleglobe 2Mbps bi-directional
- BT 512Kbps bi-directional
- USE1 2Mbps upstream and 8Mbps downstream

The total International Internet bandwidth had remained about 2Mbps in the 1990s but by 2000 it had grown to 10.5 Mbps as shown in figure 3.1 below

Figure 3.1: International Internet bandwidth for Kenya (Mbps)

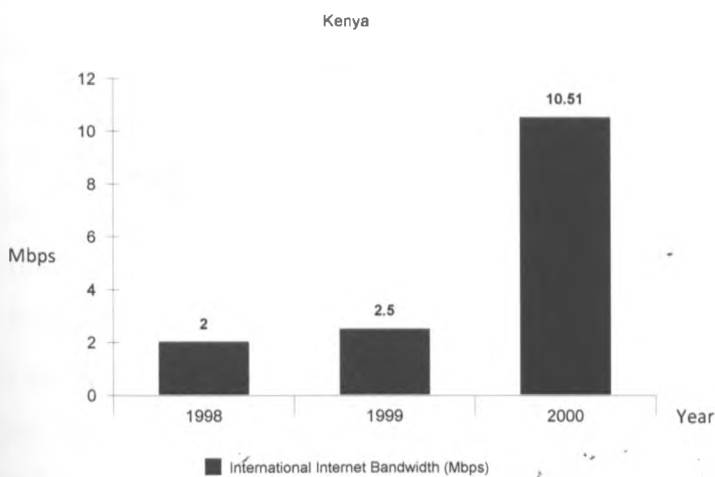

Source: ITU

Between 1998 and 2000, the monthly cost of leasing a 64 Kbps link decreased from a high of \$12,500 to \$4,500. At the same time, many cyber cafes mushroomed all over the main towns and competition among the service providers was evident.

In July 1999 the government officially liberalized the telecommunications market in Kenya. The Communication Commission of Kenya (CCK) was formed to regulate the sector. However, Telkom Kenya, formed from the telecommunications arm of the former KPTC, was allowed a monopoly to operate an Internet backbone for five years, until 2004.

During the exclusivity period, Telkom developed and expanded a national backbone. The coverage area was limited to the main urban centers and for a long time availability, reliability and quality of the services provided was way below average. During this period, the Internet market in Kenya witnessed rapid expansions and the user base grew to over 500,000 users.

On average the cost of full unlimited dial up Internet account per month was Ksh.5,000 plus VAT per month in the year 2000 plus the telecom usage charge. This has now reduced to a cost of Ksh1,000 plus VAT per month. With the emergence of cyber cafes, this cost has reduced from Kshs 5.00-10.00 per minute in 2000 to the current cost of between Ksh0.50-1.00 per minute. The cost has further reduced with the introduction of mobile internet services. This reduction in consumer tariffs has enabled access to Internet service by more Kenyans, especially in the low income bracket.

By 2005, Telkom Kenya revised its domestic leased line tariffs, through its Jambo Telkom subsidiary, which had remained constant since 2000. The Kenstream charges (dedicated point-to-point domestic links) remained the same until July 2006 when Telkom reduced them by 50%. This reduction can be associated with competition in provision of domestic leased lines following the licensing of several Public Data Network Operators [Waema et al, 2007]. The other PDNOs followed suit and reduced their domestic leased line tariffs.

In January 2006, ISP licenses were modified to permit VoIP services. Before the modified licenses could be issued, all licensed ISPs were required to make their outstanding statistical returns to CCK. Those ISPs that did not meet the

requirements were deregistered through a gazette notice. According to the Kenya Gazette Notice dated 6th October, 2006, CCK revoked the licenses of 30 ISPs.

Until 2005, only ISPs could offer Internet services. However, the situation has changed since CCK issued a new licensing framework in late 2004 after the TKL's monopoly came to an end in June 2004. For example, two Internet Backbone Gateway Operators were licensed in December 2004 and Telkom Kenya, through its subsidiary Jambo Telkom, moved into the Internet market in 2005/2006. Mobile companies Safaricom and Celtel (now Zain) started offering mobile Internet services in the form of GPRS and EDGE [Waema et al, 2006].

According to Waema et al (2007), Kenya has lost several opportunities that in all likelihood would have led to increased growth in the Internet market, since the end of Telkom's monopoly in 2004. One of these opportunities was the planned licensing of a Second National Operator (SNO) to compete with Telkom Kenya, which failed in 2004 for different reasons. The second opportunity that was lost was the planned privatization of a majority stake in Telkom. This was postponed to 2006. The situation has however changed, and the envisaged growth is now visible. Telkom Kenya was privatized, and a third mobile operator has already commenced operations.

On the positive side, key successes have been reported, including:

- The lifting of the ban on VoIP;
- Telkom Kenya's monopoly in the provision of Internet backbone and international bandwidth services expired, with the entry of new operators leading to reductions and improved quality of services; and
- Enormous growth in the mobile telephony sector.
- The key challenges in the growth of Internet, in Kenya, include cost of Internet use, lack of local content, and narrow focus on the part of the ISPs, inadequate regulatory framework, unfriendly interconnection process, unpredictable business environment and poor local access network infrastructure [Waema et al, 2006].

The privatization of majority stake in Telkom, and the commencement of operation by the country's third mobile service provider, is two other key successes in the recent year. This has led to increased competition, particularly in

the provision of data services. This is expected to have positive impact on the growth of Internet use in Kenya.

The landing of the undersea fiber optic cable in Mombasa has also introduced a strong catalyst in this growth. The East African Marine System (TEAMS) cable and the SEACOM marine cable system have already landed and are expected to provide an addition 1.28Tbps (SEACOM) and 1,2Tbps (TEAMS). Also the same may be said for the expected landing of the East Africa submarine System (EASSy) cable in 2010.

3.2 Existing Internet infrastructure in Kenya

In most countries, Kenya included, fixed telephone lines formed the platform upon which Internet services were developed. Dial-up connectivity and analog leased lines were the initial set of Internet access services offered. The fixed line teledensity influenced the adoption and growth of the Internet users. However, fixed digital leased lines later became the dominant mode of providing permanent internet connections to organizations [Waema et al, 2006].

Kenya liberalized its telecommunications sector in 1999 after the Kenya Communication Act 1998 became operational. This led to the formalization of market structures and advent of activities geared towards the development of the telecommunications markets in total. On the Internet front, ISPs were licensed to operate formally and the incumbent was given the monopoly to operate the Internet Backbone as well as the provision of access circuits (leased lines, VSAT, etc) for 5 years until July 2004. Though Telkom Kenya developed and expanded a national backbone, the coverage area was limited to the main urban centres and for a long time availability, reliability and quality of the services provided was way below average.

Two mobile operators, Safaricom and Kencel (currently Zain), were licensed and continue to operate as a duopoly. Later in 2008, Telkom launched its mobile service "Telkom Wireless". This was later converted to Orange Mobile, after the privatization of Telkom. The Licensed third operator, econet wireless, also commenced operations in 2009, under the YU brand. This has introduced the much desired competition, leading to better services.

The mobile Telephone sector in Kenya has experienced tremendous growth as shown in Figure 3.2. However, as at 2005, the mobile teledensity of Kenya of 20% was still half that of Morocco (40%) and one-third that of Poland (60%).

Dial-up mobile Internet services were introduced by Kencel (now Zain) in early 2001 but were expensive because of the per-minute mobile charges. In the period 2005-2006, the mobile operators introduced Mobile Internet services using GPRS and EDGE technologies and with flat volume-based pricing. This has increased the number of Mobile Internet customers to over 250,000 in the last one year. This number is higher than the total number of fixed dial-up Internet customers. It is likely, that the growth of Internet services in Kenya will follow the growth of Mobile telephone services.

Figure 3.2: Mobile teledensities with comparator countries

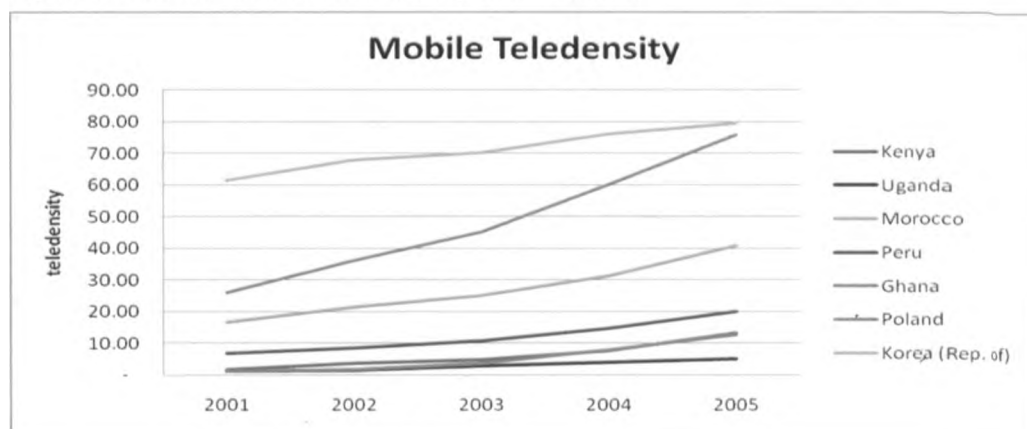

Source: ITU

Internet services are currently provided by hierarchy of providers from backbone providers, who purchase bandwidth from the global Internet backbone, to ISPs who sell Internet services to the end-users. The costs at each level of the hierarchy are passed down the level below, sometimes with very little value-addition, and ultimately are paid for by the Internet users.

All International Internet bandwidth in Kenya is satellite-based. This is however expected to change with the launch of the undersea optical fiber connections to Kenya, which landed in June 2009. Satellite Internet bandwidth costs per month in Kenya are on average about US \$2,100 per Mb/s. This is a high Internet bandwidth cost when compared to the minimum satellite bandwidth cost in Kenya

of only US \$625 per Mb/s and under US\$ 500 per Mb/s per month possible with an undersea optical fiber. Consequently, Internet gateway operators use asymmetrical configurations to reduce the total cost of international Internet bandwidth. The costs are thus expected to go down tremendously once the ISPs are linked via the undersea optical fiber connections to the global Internet. It is expected to be even cheaper with the landing of the third undersea connection in 2010.

The total gateway bandwidth in Kenya has grown progressively to a total of 758.59 Mbps as at 2005/2006 as shown in table 3.1 below. It is to be noted that this bandwidth has increased tremendously since the end of TKL's exclusivity period, doubling in 2004/2005 and more than doubling in 2005/2006 from the previous year.

Table 3.1: International gateway bandwidth

| | 2001/02 | 2002/03 | 2003/04 | 2004/05 | 2005/06 |
|---|---------|---------|---------|---------|---------|
| International gateway downlink bandwidth (Mbps) | 62.24 | 102.32 | 84.91 | 180.75 | 660.83 |
| International gateway downlink bandwidth per inhabitant (bps) | 2.06 | 3.33 | 2.70 | 5.64 | 20.26 |
| International gateway uplink bandwidth (Mbps) | 20.51 | 24.61 | 26.20 | 42.63 | 97.77 |
| International gateway total bandwidth (Mbps) | 82.75 | 126.92 | 111.10 | 223.38 | 758.59 |
| Ratio of downlink to uplink bandwidth | 3.03 | 4.16 | 3.24 | 4.24 | 6.76 |

Source: Internet Analysis Study







Three major submarine cables are currently being deployed to offer east and southern African countries with much needed cheap connectivity [Adam L., 2008].

- (a.) The SEACOM submarine cable due to become operational during the third quarter of 2009 is being built by a consortium of private companies including Herakles, Blackstone, Aga Khan Fund, Venfin, Convergence Partners, Shanduka and the second national operator of South Africa Neotel.
- (b.) The East African Marine System (TEAMS) owned by the Government of Kenya, the Kenyan private sector and UAE based mobile operator Etisalat is another cable due to be operational during the second half of 2009.

- (c.) The East African Submarine Cable System (EASSy) that is financed by public and private operators from east and southern African countries, the International Finance Corporation, the European Investment Bank, and the African Development Bank among others is expected to be operational in 2010.
- (d.) The West African sea board that is being served by the SAT3 cable is also expected to secure a cheaper fibre alternative when the 14,000Km West African Cable System (WACS) becomes operational in 2011. The consortium that is building WACS consists of an equal share split between Telkom, Neotel, MTN, Vodacom, and the South African government's Broadband Infraco.

Figure 3.3 shows a summary of these ongoing projects

Figure 3.3 Major Africa Submarine cable projects

| Submarine Cable | Links/Distance | Major Player | Estimated cost million US\$ | Operation date |
|---|--|--|-----------------------------|---------------------|
|  SEACOM | East and southern Africa | Herakles, Blackstone; Aga Khan Fund; Venfun; Convergence Partners; Shanduka Neotel | 650 | Second half of 2009 |
|  TEAMS | Kenya to UAE 120 Gbps | Government of Kenya (40%), Etisalat (UAE) (15%) | 82-110 | 2009 |
|  EASSy | East and southern Africa | IFC, EIB, Kfw, AfDB, operators | 265-330 | 2010 |
|  WACS | West Africa, UK, 14,000 Kms. 320 Mbps | Telkom, Neotel, MTN, Vodacom, Infraco. | 510 | 2011 |
|  Glo-1 | Nigeria- UK | Glo – second national operator | 560 | 2012 |
|  Main One | Angola- Portugal | Main Street technologies | 300 | 2012 |

Source: <http://manypossibilities.net/african-undersea-cables/>

According to Adam L. [2008], Kenya has made significant strides in building a national fiber network in preparation for TEAMS, SEACOM and EASSy cables. The Kenyan government has allocated US\$80 million to connect all districts using a fibred network. To achieve this, the government secured a loan from the World Bank to enable the connectivity of academic and research institutions, through the national research and education network, KENET. In addition there are fiber connectivity initiatives by the private sector in particular the Kenya Data Network (KDN) and Kenya Power Company Limited (KPCL). Ongoing fiber projects in Kenya are shown in Figure 3.4.

Figure 3.4 Ongoing Fiber Optic projects in Kenya

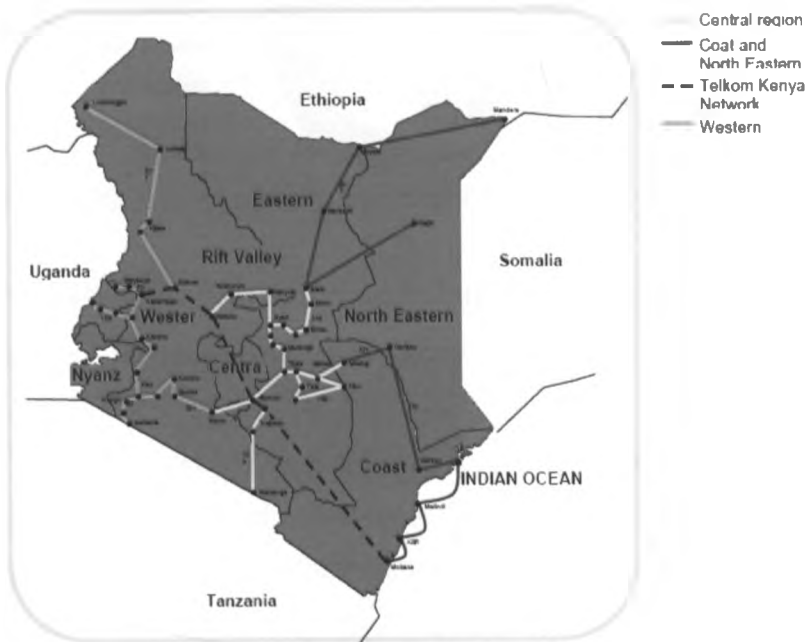

Source: Communications Commission of Kenya

With the deployment of the undersea fiber optic cable, the international bandwidth for the African countries is expected to grow as shown in figure 3.5 below. Internet users in Kenya will have an option of a 1.2Tbps through the TEAMS cable or, 320Gbps through the EASSy cable or the 1.28Tbps through the SEACOM cable.

Figure 3.5 expected international link capacities across Africa

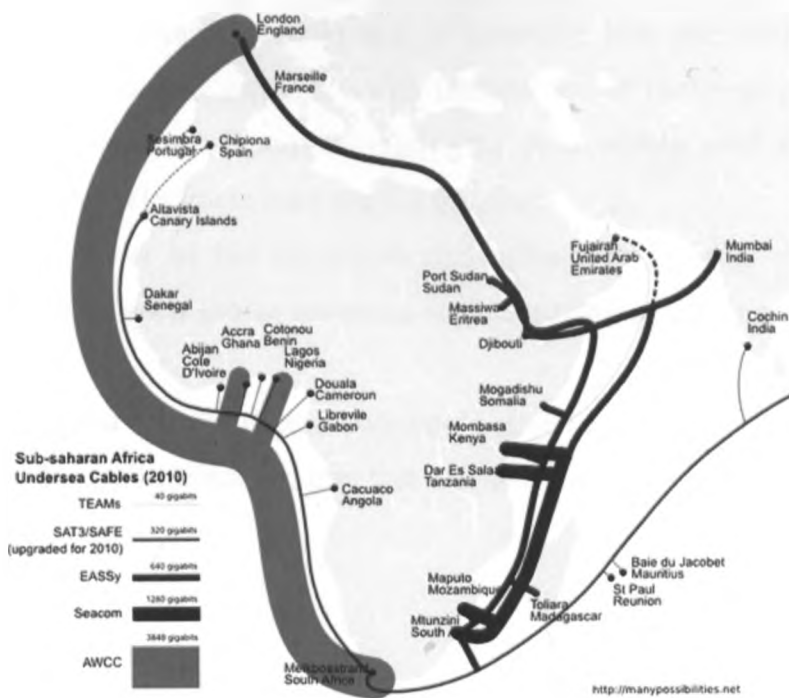

3.3 Service differentiation and Quality of Service.

Internet services in Kenya are generally differentiated on the basis of link type and connection type. On the basis of link type, user service is either wireless (VSAT or satellite) or fixed line connection. With respect to connection type, users subscribe to either dial-up or dedicated (leased line) connection.

In addition, a price differentiation factor is employed based on the bandwidth allocated over the user's connection.

There is no available documentation to indicate the existence of quality of service policy or framework. Also, there is no clear guideline on how to provide support for the existing quality of service models. As a result, Internet services in Kenya are based purely on the best-effort service, with subscription to bandwidth. This has made cost a key factor in service quality, because high bandwidth connections cost more.

The costing model employed is generally based on time spent on the connection, for dial-up connections, and fixed monthly charge for leased line clients. This is in addition to the telephone or link cost per month.

This study has established a continued desire for quality services by Internet users, and a corresponding willingness to pay for the services.

Though the degree to which applications such as VoIP, Video conferencing and video on demand, are in use is generally low, the usage is growing at a tremendous rate, especially with introduction of exchange programs, e-learning and distance education. Currently, the most widely used applications are web browsing, electronic mail and file transfers.

The number of file downloads and uploads is growing, particularly with the advent of open source resources such as software, learning materials and free e-books.

This trend calls for urgent measures to ensure the Internet infrastructure is suitable for the applications, and also that user satisfaction is achieved.

Chapter 4: Conceptual Framework:

4.1 Introduction

QoS is the collective effect of service performances which determine the degree of satisfaction of a user of the service [ITU-T E.800]. This implies that the user is the final arbiter of 'good' or 'bad' QoS. Different applications demand different service qualities. Some need minimal delay and reliable response time, while others may need a good image quality. The QoS is a difficult issue in that the relationship between application QoS parameters and network QoS parameters is very complex; QoS must be end-to-end; and the application QoS might change during connections [X. Guo, 1997].

QoS, as found on any consumer router running on a standard Internet Service Provider, will only work on upstream/outbound data (data going from you to your ISP). It is practically impossible for a service user to control the priority of data coming from the ISP, since it's only possible to control the data on your side of the modem. Thus true QoS is only possible if it's offered by the Service provider, and understood by the service user. The service level agreement need to be specific on the type of service, parameters to measure, parameter levels and the guaranteed levels.

In Kenya, the most commonly used Internet Services include web browsing, electronic mail and file transfer. These services are quite tolerant to the performance of the best-effort service. In addition, the users are generally patient enough to wait or try another time. QoS sensitive applications, such as VoIP and Video Conferencing, are growing in use in the Kenyan Internet market. However, this study established that these services are accessed on a once-off (rarely) bases. This provides little incentive to the subscription to "full time" quality of service. The Integrated Services architecture focused primarily on long-lasting and delay-sensitive applications. The World Wide Web, however, the Internet is currently dominated by web traffic, much of which is short-lived transactions. Intserv operates optimally with a local area network or a campus area network, where the number of intermediate hops is low. On an internetwork, it suffers the drawback of having to store too much flow based information on each intermediate node.

The differentiated services model assumes the ability, on the user's end, to specify and configure application parameters and classes. However, majority of Internet users have little or no knowledge on the QoS services or parameters. This makes it difficult to implement DiffServ on the Kenyan Internet market.

4.2 The Intserv over Diffserv service model

The conceptual framework proposed herein is based on the Intserv over Diffserv service implementation model [RFC 2998] as described section 2.5.4, and in figure 4.1 below.

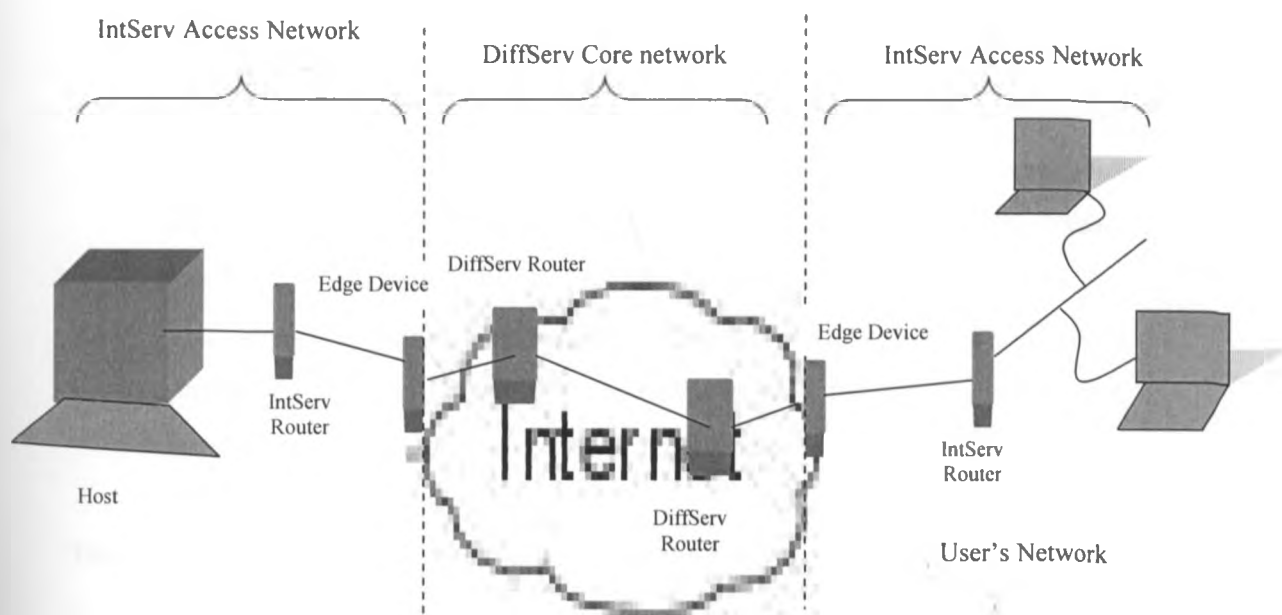

Figure 4.1: Intserv over Diffserv service implementation

It focuses on maximizing the advantages of the Integrated services (Intserv) model, within the user's network, and the Differentiated services (Diffserv) model, within the internetwork. Both the Internet user and the service provider implement Intserv at the endpoints, while the transit network is Diffserv based.

This implementation has three major components, namely

- (i) The **Intserv Access Network** – This consists of the configurations on the user's internal network, based on the integrated services (Intserv) approach. It shall specify the service type, the supported applications, and

QoS parameters for the service. This component is defined on both the user's and the service provider's ends of the communication.

- (ii.) The *Diffserv Core Network* – This comprises of the interconnection technology from the user's router (gateway) to the service provider's gateway. It defines the resource assurances that the physical infrastructure will be able to support for the services. It comprises a set of Diffserv routers that collaborate in the delivery of the requested service.

The service provider specifies the infrastructure requirements for each of the services supported.

- (iii.) The *edge device* – This consists of the services and configurations on the service provider's endpoint. It defines how the requested service is offered by the service provider. This component contains the specifications of the service types, service interfaces, supported applications and QoS parameters for the service offered. It includes an admission control mechanism to accept or reject a request for service.

- (iv.) The service *mapping algorithm* – This determines how the Diffserv service classes are mapped to the Intserv service definition, and vice versa. For simplicity of application, direct/default mapping has been employed in this implementation.

The Intserv over Diffserv model however has the following limitations:

- It does not specify the minimum infrastructure requirements for services.
- It does not specify the parameter mapping necessary to support the various services.
- It does not define any service classes for QoS implementation, leaving the choice to the user. This makes implementation of the service a difficult decision to make.
- It does not factor service evaluation in the implementation of QoS.

To ensure simplicity in the implementation of QoS, the proposed framework focuses on three broad components:

- Service specification
- Service implementation
- Service implementation.

Chapter 5: Research Methodology

5.1 Research design

The primary data for this research was obtained from the Internet service providers (ISPs). These included:

- The type of service (s) offered to the users, as per the service level agreement (SLA).
- Any service differentiation approach used, including: dial-up versus dedicated, high-bandwidth versus low-bandwidth, etc.
- Any application specific provisions and/or guarantees offered/implied in the SLA. Including: minimum bandwidth, percentage daily service availability, maximum delay, reliability, etc.
- Parameters considered when offering service to users.
 - The available bandwidth.
 - The available infrastructure, etc.
- Any measure taken to ensure service promised is actually delivered to the users. E.g. Infrastructure agreement.
- Service costing model used. E.g.
 - Number of hours of connection.
 - Number of bytes delivered.
 - Fixed monthly rate.
 - Bandwidth dependent fixed monthly rate.
 - Fixed rate plus variable rate.
 - Fixed rate plus variable bandwidth rate, etc.
- Support for implementation of the existing QoS models; the Diffserv and Intserv models.

Secondary data was obtained from the Communications Commission of Kenya (CCK) and a random sample of users. This will include:

- From the CCK:
 - Current service guidelines for Internet service provision.

- The acceptable service levels for different internet applications, particularly VoIP, audio on demand, video conferencing and video on demand.
- List of registered ISPs.
- Any existing service/application specific guidelines.
- Internet infrastructure and associated guidelines.
- From the user sample:
 - The desirable service, based on availability, reliability, delay, cost, etc.
 - Desired service differentiation approach: by service supported, by bandwidth levels, by bits/bytes delivered, guarantees/provisions offered.
 - Desired costing model/approach.

5.2 Data collection methods

The following data collection methods were employed in this research:

- Semi-structured questionnaires
- Interviews
- Review of documentation.

In addition, literature survey, preliminary interviews and observation methods were used in obtaining preliminary data for the research.

To obtain the primary data, a random sample of the Internet Service Provider was taken. A questionnaire was used to collect the information from the selected ISPs, and a subsequent interview was organized, where necessary, to gather additional information, and obtain any necessary clarifications on the collected data.

Secondary data was obtained from the service regulator, the Communication Commission of Kenya (CCK) and a randomly selected user sample.

Necessary documentation on service and infrastructure guidelines was obtained from the CCK. This was used to obtain information on the existing services, service levels and service providers. In addition, an informal interview was conducted with one of the representatives of CCK.

A random sample of fifty (50) users was selected, and a questionnaire was issued to each. This provided information on the user's perception of the existing services, and the desired service levels.

Chapter 6: Data Analysis and Results

6.1 Analysis of collected data

The purpose of the study was to come up with a proposed framework for the implementation of Internet Quality of Service in Kenya. The data presented herein was gathered from three main sources; namely the communications commission of Kenya (CCK), a sample of Internet Service Providers (ISPs) and a sample of 50 Internet users.

In addition, preliminary data was gathered from literature survey, preliminary interviews and observations.

Before the data was analyzed, all the questionnaires were adequately checked for accuracy and completeness. The information was then coded and entered into a relational EPI-data® database and analyzed using Statistical Package for Social Sciences (SPSS®). Exploratory analysis was first performed to ensure that the output was free from outliers and the effect of missing responses was at minimum. Descriptive methods of data analysis were applied. The findings are presented by use of tables, bar charts and pie charts.

The organization of the results is as follows: section 5.1 presents the findings on the preliminary data; section 5.2 presents findings on data from CCK; section 5.3 presents findings on data from the user sample; and Section 5.4 presents findings on data from ISPs.

6.2 Preliminary Data

The preliminary data was obtained by review of documentation, informal interviews and observation. The following results were obtained:

- There was no evidence of any policy document, either from the service regulator (CCK), or the government addressing quality in Internet provision. The CCK however, in the CCK policy guideline on the provision of VoIP [2005], states that service providers are required to meet the quality of service requirements as may be set out by the commission:

- The operations of Internet services are generally regulated by the Communication Act (2001), which basically has no specific reference to the Internet services. With respect to quality of service, the act states that “interconnection agreements shall provide for adequate capacity, service levels and reasonable remedies for any failure to meet those service levels”.
- Most of the Internet users are ignorant of their entitlement to quality of service.
- There was general feeling of dissatisfaction, on the part of Internet users, with the services they received from their providers. In addition, the users exhibited little or no knowledge of quality of service concepts.
- Internet service providers basically provide service differentiation on the basis of either price, or the type of connection. No specific guarantees are attached to the user contracts.
- There are fifty three (53) licensed Internet Service Providers. Among these, only 39 were found to be active. In addition, some of the service providers also double up as infrastructure providers.
- From observation, the Internet services experienced frequent down-times, for leased-line clients. For dial-up clients, it was observed that the data rates specified in the service contract was never achieved. For example, most dial-up clients observed had a 64kbps connection, which only provided a maximum of 21kbps.
- Most dial-up clients were noted to be connected through points-of-presence. This partly contributed to the low data rates achieved, and also poor response time in case of service down-time. This was further attributed to the oversubscription of the lines, by the providers, in order to maximize on profits.

6.3 Data from CCK

The communications commission of Kenya (CCK) categorizes Internet traffic into two categories.

- Audio and video applications. .

- Data applications.

Audio applications include conversational voice, voice messaging, and high quality streaming audio. Tables 6.1 provides a description of audio and video applications, while table 6.2 illustrate the performance parameters and targets for audio and video applications.

Video traffic is divided into videophone (conferencing) and one-way video (video on demand). Data applications fall under thirteen categories, as shown in table 6.3

Table 6.1– Performance targets for audio and video applications

| Medium | Application | Degree of symmetry | Typical data rates |
|--------|------------------------------|--------------------|--------------------|
| Audio | Conversational voice | Two-way | 4-64 kbit/s |
| Audio | Voice messaging | Primarily one-way | 4-32 kbit/s |
| Audio | High quality streaming audio | Primarily one-way | 16-128 kbit/s |
| Video | Videophone | Two-way | 16-384 kbit/s |
| Video | One-way | One-way | 16-384 kbit/s |

Source: CCK

Table 6.2 - Key performance parameters and target values for audio and video applications

| Application | One-way delay | Delay variation | Information loss | Other |
|------------------------------|--|-----------------|------------------------------|-----------------------|
| Conversational voice | <150 ms preferred <400 ms limit | < 1 ms | < 3% packet loss ratio (PLR) | |
| Voice messaging | < 1 s for playback < 2 s for record | < 1 ms | < 3% PLR | |
| High quality streaming audio | < 10 s | << 1 ms | < 1% PLR | |
| Videophone | < 150 ms preferred <400 ms limit | | < 1% PLR | Lip-synch: < 80 ms |
| One-way video | < 10 s | | < 1% PLR | |

Source : CCK

The values in tables 6.1 and 6.2 are subject to the following considerations:

- The value of one-way delay for conversational voice is subject to an assumption of adequate echo control.

- The exact values, for the information loss, depend on specific codec, but assume use of a packet loss concealment algorithm to minimise effect of packet loss.
- The data rates for high quality streaming audio are very dependent on codec type and bit-rate.
- The one-way delay values for videophone are to be considered as long-term target values which may not be met by current technology.

Table 6.3 and 6.4 provides description and an indication of suitable performance targets for data applications.

Table 6.3 – Performance targets for data applications

| Medium | Application | Degree of symmetry | Typical amount of data |
|--------|--|----------------------|------------------------|
| Data | Web-browsing – HTML | Primarily one-way | ~10 KB |
| Data | Bulk data transfer/retrieval | Primarily one-way | 10 KB-10 MB |
| Data | Transaction services – high priority e.g. e-commerce, ATM | Two-way | < 10 KB |
| Data | Command/control | Two-way | ~ 1 KB |
| Data | Still image | One-way | < 100 KB |
| Data | Interactive games | Two-way | < 1 KB |
| Data | Telnet | Two-way (asymmetric) | < 1 KB |
| Data | E-mail (server access) | Primarily one-way | < 10 KB |
| Data | E-mail (server to server transfer) | Primarily one-way | < 10 KB |
| Data | Fax ("real-time") | Primarily one-way | ~ 10 KB |
| Data | Fax (store & forward) | Primarily one-way | ~ 10 KB |
| Data | Low priority transactions | Primarily one-way | < 10 KB |
| Data | Usenet | Primarily one-way | Can be 1 MB or more |

Source: CCK

Table 6.4 - Key performance parameters and target values

| Application | One-way delay (Note) | Delay variation | Information loss |
|--|---|-----------------|-----------------------|
| Web-browsing – HTML | Preferred < 2 s /page Acceptable < 4 s /page | N.A. | Zero |
| Bulk data transfer/retrieval | Preferred < 15 s Acceptable < 60 s | N.A. | Zero |
| Transaction services – high priority e.g. e-commerce, ATM | Preferred < 2 s Acceptable < 4 s | N.A. | Zero |
| Command/control | < 250 ms | N.A. | Zero |
| Still image | Preferred < 15 s Acceptable < 60 s | N.A. | Zero |
| Interactive games | < 200 ms | N.A. | Zero |
| Telnet | < 200 ms | N.A. | Zero |
| E-mail (server access) | Preferred < 2 s Acceptable < 4 s | N.A. | Zero |
| E-mail (server to server transfer) | Can be several minutes | N.A. | Zero |
| Fax ("real-time") | < 30 s/page | N.A. | <10 ⁻⁶ BER |
| Fax (store & forward) | Can be several minutes | N.A. | <10 ⁻⁶ BER |
| Low priority transactions | < 30 s | N.A. | Zero |
| Usenet | Can be several minutes | N.A. | Zero |

Source: CCK

6.4 Data from Internet Users

The organization of the results is as follows: section 6.4.1 presents findings on the respondents; section 6.4.2 presents findings on the status of internet infrastructure; Section 6.4.3 presents findings on internet services and Section 6.4.4 presents findings on the quality of service.

6.4.1 Information on the respondents

The targeted sample comprised of network users and network administrators. The data presented herein was gathered from 50 respondents who comprised of network administrators and network users as indicated in Table 6.5.

Table 6.5: Status of the internet user interviewed (N=46)

| | Frequency | % of the total |
|-----------------------|-----------|----------------|
| Network administrator | 26 | 56.5% |
| Network user | 20 | 43.5% |
| Total | 46 | 100.0% |

6.4.2 Internet Infrastructure

This part sought to establish the infrastructure available to the Internet users in Kenya, in accessing the availed Internet services. It focuses on three aspects of infrastructure, as presented in the following section: section 6.4.2.1 Mode of Internet access; section 6.4.2.2 Type of connection; and section 6.4.2.3 Connection speeds as per service level agreements.

6.4.2.1 Mode of internet access

The research questionnaire had sought to establish how the respondents access Internet services. The options available included personal computer, workplace computer, and from a cyber café. Table 6.6 presents a multiple response analysis on the various points of access of internet services as identified by the respondents.

Table 6.6: Internet services' points of access

| | n | % of the total |
|--|----|----------------|
| Personal computer with connection (N=50) | 12 | 24.0% |
| Computer at the work place (N=50) | 6 | 12.0% |
| Computer in a cyber café (N=50) | 38 | 76.0% |

6.4.2.2 Types of Connection

Figure 6.1 presents a split of responses regarding the types of connections used in accessing internet services.

Figure 6.1: Types of Connections Used (N=48)

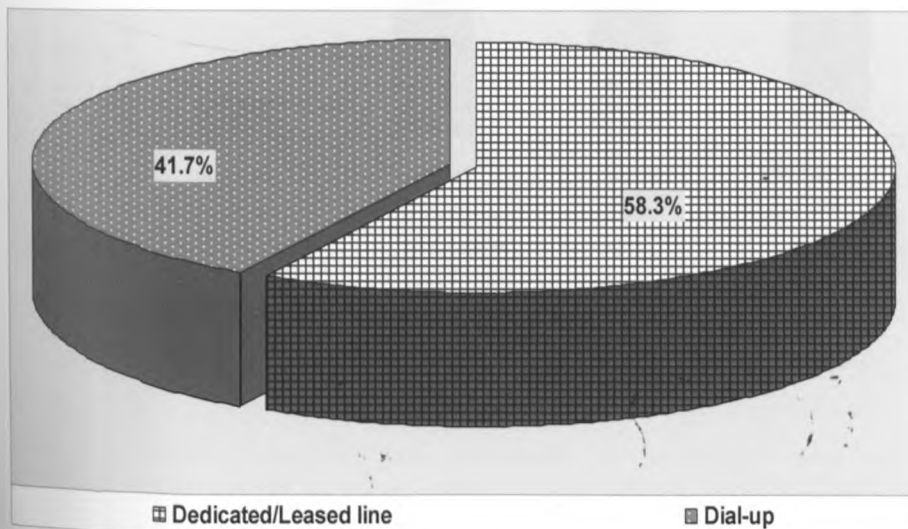

Table 6.7 further indicates whether the network users connect directly to the ISPs or through Points-of-Presence (PoPs).

Table 6.7: Preferred modes of connection (N=42)

| | N | % of the total |
|--------------|-----------|----------------|
| ISP | 34 | 81.0% |
| PoP | 8 | 19.0% |
| Total | 42 | 100.0% |

6.4.2.3 Connection Speeds as per service level agreements

Figure 6.2 indicates the distribution of responses on the level of connection speeds (bandwidth) applied in accessing internet services. The mean minimum speed for the sample was found to be 87.6kbps while the mean maximum speed was found to be 272.92kbps.

Figure 6.2: Connection speeds as per service level agreements (N=48)

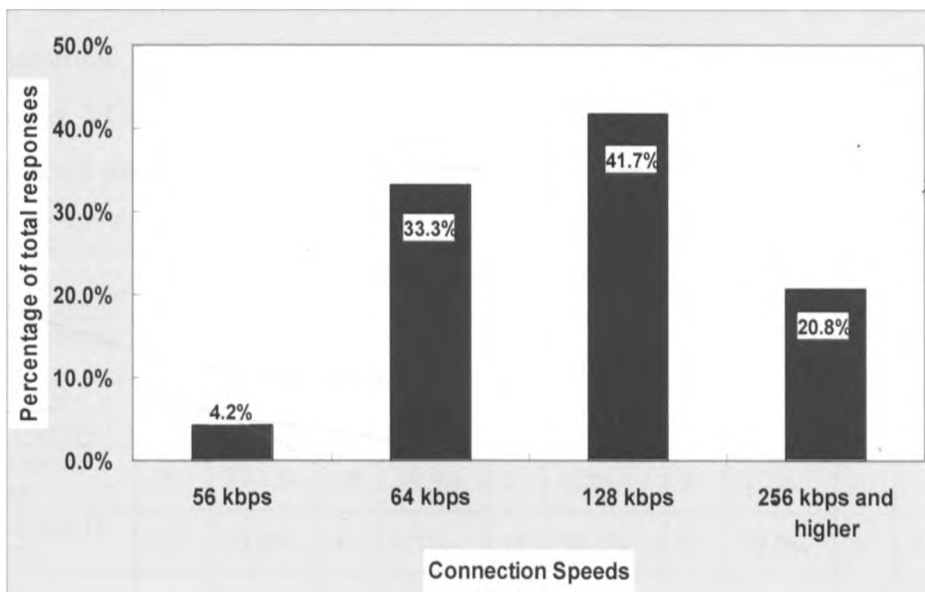

6.4.3 Internet Services

This part sought to establish the Internet services offered from the user's perspective. It focuses on three aspects, as presented in the following section: section 6.4.3.1 Type of services sought during Internet access; section 6.4.3.2 Frequency of service use; and section 6.4.3.3 Internet service costing.

6.4.3.1 Types of services sought via the internet

The respondents were requested to indicate the types of services they seek via the internet. The obtained results are summarized in table 6.8 below.

Table 6.8: Types of internet services used (N=50)

| | n | % of the total |
|-------------------------------------|----|----------------|
| Web browsing | 48 | 96.0% |
| Electronic mail | 40 | 80.0% |
| File transfer (Downloads & Uploads) | 44 | 88.0% |
| Voice over IP | 16 | 32.0% |
| Video conferencing | 6 | 12.0% |

6.4.3.2 Frequency of Service use:

In line with the findings of Table 6.8, Table 6.9 indicates that web browsing, electronic mail, and file transfers are the services often sought by internet users while VOIP is occasionally used. The findings indicate that majority of the Internet user rarely use the video conferencing service.

Table 6.9: Frequency of use of internet in seeking various services

| | Very often | | Often | | Occasionally | | Rarely | | Never | |
|---------------------------|------------|-------|-------|-------|--------------|-------|--------|-------|-------|-------|
| | n | % | N | % | n | % | n | % | n | % |
| Web browsing (N=50) | 40 | 80.0% | 8 | 16.0% | - | - | 2 | 4.0% | - | - |
| Electronic mail (N=50) | 38 | 76.0% | 6 | 12.0% | 6 | 12.0% | - | - | - | - |
| File transfer (N=48) | 16 | 33.3% | 28 | 58.3% | 2 | 4.2% | 2 | 4.2% | - | - |
| Voice over IP (N=42) | 10 | 23.8% | 4 | 9.5% | 16 | 38.1% | 8 | 19.0% | 4 | 9.5% |
| Video conferencing (N=48) | 2 | 4.2% | 6 | 12.5% | 8 | 16.7% | 18 | 37.5% | 14 | 29.2% |

6.4.3.3 Mode of Costing Internet Services by the Providers

The questionnaire had sought to identify if the cost of internet services is levied on the basis of time duration, a flat rate, bandwidth, or other approaches. The responses were based on a multiple response structure. The findings presented in Table 6.10 indicate that costing by 'time duration' and by 'bandwidth' are the most popular modes of costing internet services.

Table 6.10: Mode of costing internet services by providers

| Mode of costing | n | % of the total |
|-----------------------------|----|----------------|
| By time duration (N=50) | 32 | 64.0% |
| Flat rate, plus time (N=50) | 6 | 12.0% |
| By bandwidth (N=50) | 18 | 36.0% |
| Other (N=50) | 0 | 0.0% |

Table 6.11 further indicates the split of responses regarding the users' preferred modes of costing Internet services. The findings indicate that a majority of the users would prefer a tariff structure of costing services on a single flat monthly rate (36%), while 32% would prefer a costing structure based on time, depending on bandwidth. Sixteen percent reported that they would prefer a costing structure based on the bytes sent, while the other 16% preferred a costing structure based on time, regardless of bandwidth.

Table 6.11: Preferred mode of costing internet services

| Preferred mode | n | % of the total |
|----------------------------------|----|----------------|
| By time, depending on bandwidth | 16 | 32.0% |
| By the bytes sent | 8 | 16.0% |
| By time, regardless of bandwidth | 8 | 16.0% |
| A single flat rate per month | 18 | 36.0% |

6.4.4 Quality of Service

Table 6.12 is a cross-tabulation to indicate the extent of users' awareness about the internet Quality of Service (QoS). The table indicates that 50% the network administrators (12 out of 24) reported to be aware of internet QoS, and 50% of network users (10 out of 20) reported were reported to be aware of Internet QoS.

This indicates that the concept of internet QoS is generally known with the same percentage among network administrators as well as network users.

Table 6.12: Extent of Users' awareness of internet QoS (N=44)

| Type of users | Do you know about internet QoS? | | | | | | | |
|------------------------|---------------------------------|--------------|-----------|--------------|----------|--------------|-----------|-------------|
| | Yes | | No | | Not sure | | Total | |
| | n | % | n | % | n | % | n | % |
| Network administrators | 12 | 27.3% | 8 | 18.2% | 4 | 9.1% | 24 | 54.5% |
| Network users | 8 | 18.2% | 10 | 22.7% | 2 | 4.5% | 20 | 45.5% |
| Total | 20 | 45.5% | 18 | 40.9% | 6 | 13.6% | 44 | 100% |

Figure 6.3 presents findings regarding whether or not the ISPs offer guarantees to their clients on the level of service provided. The findings indicate that a majority of the respondents (52.2%) reported that the ISPs do not offer any guarantee on the quality of services they provide. 30.4% reported having guarantees on the QoS from their ISPs.

Figure 6.3: Whether ISPs offer guarantee on the level of service (N=46)

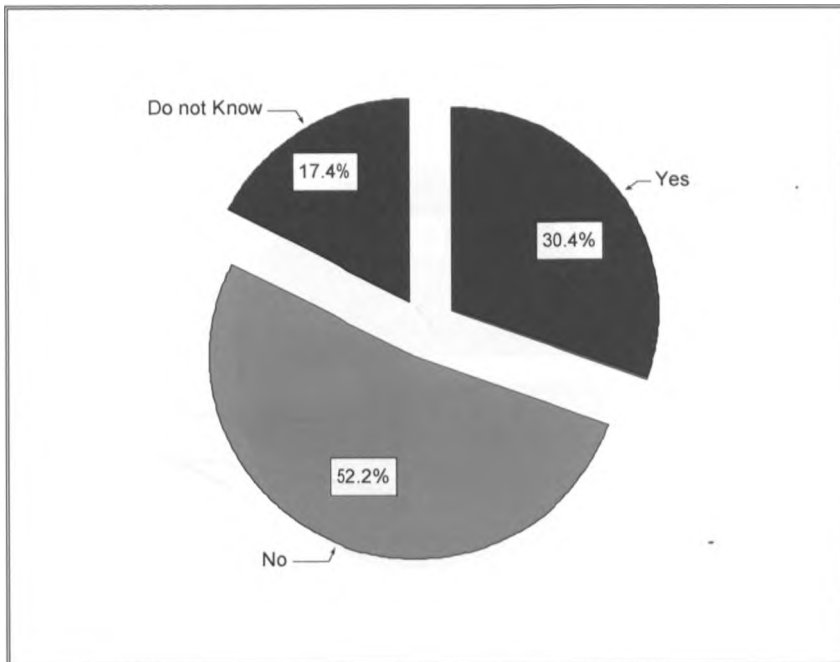

Table 6.13 shows the distribution of responses regarding whether or not the ISPs offer support for existing QoS models namely the Diffserv, Iftserv, and MPLS. The findings indicate that over 70% of the respondents reported lack of support

from their ISPs in all the three QoS models. This indicates that the ISPs lay very little emphasis in providing support for existing QoS models.

Table 5.13: Availability of support from ISPs for existing QoS models

| | Yes | | No | | Not sure | |
|------------------|-----|-------|----|-------|----------|-------|
| | N | % | n | % | n | % |
| Diffserve (N=42) | 10 | 23.8% | 16 | 38.1% | 16 | 38.1% |
| Intserv (N= 40) | 8 | 20.0% | 14 | 35.0% | 18 | 45.0% |
| MPLS (N=42) | 6 | 14.3% | 18 | 42.9% | 18 | 42.9% |

The findings presented in Figure 6.4 indicate the level of users' perception towards the quality of internet service. The findings indicate that 52% of the respondents cited dissatisfaction with the internet services offered. The users attributed their dissatisfaction to the following aspects: lack of reliable ICT infrastructure; slow connection speeds; loss of data during network failures; instabilities within networks; long delays by the ISPs in sorting out link failures.

Figure 5.4: Level of perceived quality of internet service

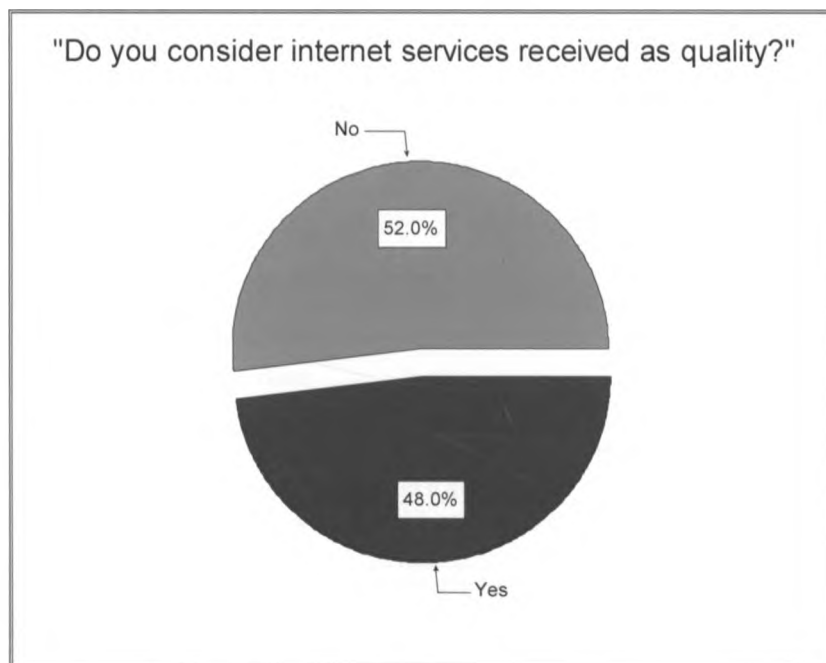

Table 6.14 presents various factors that users may apply in determining acceptable service levels. The respondents were requested to rate them in the order of importance towards determining acceptable service levels. As indicate in

the table, the three most highly rated factors included cost (72%); link availability (76%); and link capacity/bandwidth (72%). Packet loss rate, average link speed, and delay variation / jitters were rated by a cross section of respondents as both necessary and important factors to consider in determining acceptable service levels.

Table 6.14: Factors to consider in determining acceptable service levels

| | Very important | | Important | | Necessary | | Optional | |
|----------------------------------|----------------|-------|-----------|-------|-----------|-------|----------|------|
| | n | % | n | % | n | % | n | % |
| Cost (N=50) | 36 | 72.0% | 14 | 28.0% | - | - | - | - |
| Link availability (N=50) | 38 | 76.0% | 10 | 20.0% | 2 | 4.0% | - | - |
| Link capacity/ Bandwidth (N=50) | 36 | 72.0% | 10 | 20.0% | 4 | 8.0% | - | - |
| Packet loss rate (N=46) | 22 | 47.8% | 10 | 21.7% | 10 | 21.7% | 4 | 8.7% |
| Average link speed (N=50) | 24 | 48.0% | 16 | 32.0% | 8 | 16.0% | 2 | 4.0% |
| Delay variation / Jitters (N=48) | 16 | 33.3% | 20 | 41.7% | 8 | 16.7% | 4 | 8.3% |

Table 6.15 indicates the split of responses regarding the desired types of services by users. The findings indicate that a majority of the respondents reported that they would prefer a fast link with guaranteed minimum bandwidth. In addition, 22% of the respondents reported they would prefer a connection with guaranteed availability, regardless of speed. This indicates that the two important aspects that users consider in evaluating quality of service are the bandwidth of the network links and reliability of the connection.

Table 6.15: Desired service types

| | n | % of the total |
|--|----|----------------|
| Prefer fast link with guaranteed minimum bandwidth (N=44) | 34 | 77.3% |
| Wouldn't mind a low speed link provided I only pay for the bytes sent or received (N=44) | 4 | 9.1% |
| Would prefer a connection with guaranteed availability, regardless of speed (N=44) | 10 | 22.7% |

Figure 5.5 indicates that a majority of the respondents (80.0%) reported that they would be willing to pay more to obtain better and quality services:

Figure 5.5: Willingness to obtain better and quality services (N=50)

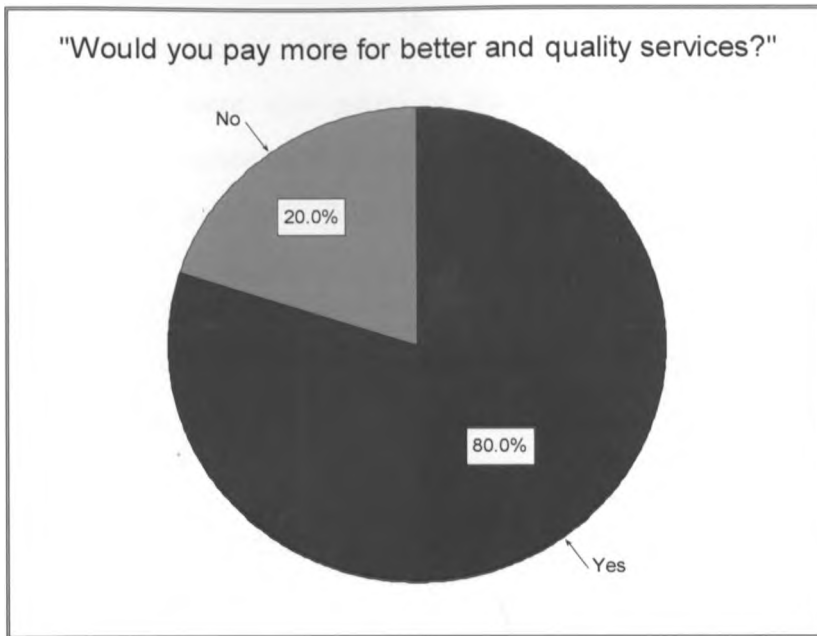

6.5 Data from ISPs

The targeted sample comprised of Internet Service Provider. A total of fifteen questionnaires were issued out. Only twelve of them were returned.

The data collected was first analyzed to eliminate outliers, and then coded using MS-Excel application tools. The results are represented below as per each of the data collection objectives: section 6.5.1 Internet services; section 6.5.2 Internet Infrastructure; and section 6.5.3 Quality of service.

6.5.1 Internet Services

This section sought to establish the services offered by ISPs to their customers, including the service levels and differentiation approaches. The findings are presented in the following five sections: section 6.5.1.1 Internet Services; section 6.5.1.2 service differentiation; section 6.5.1.3 service costing; section 6.5.1.4 service level guarantees; and section 6.5.1.5 service level agreements.

6.5.1.1 Type of service:

This section sought to know the services offered by ISPs to their clients. The options provided were dial-up Internet, Leased line and Voice over IP. The results are summarized in table 6.16 below.

The respondents were also asked to list other services that they offer. All respondents also indicated that they offer domain name registration and web hosting. The results are as in Table 6.16 and figure 6.6 below:

Table 6.16: Type of services offered

| Type of Service | No. of Respondents | % respondents |
|-----------------------|--------------------|---------------|
| Dial-up internet N=12 | 12 | 100.00 |
| Leased line N=12 | 12 | 100.00 |
| Voip N=12 | 5 | 41.67 |

6.5.1.2 Service Differentiation

The respondents were asked to indicate the approach they use in service differentiation. The data collected indicated the connection type and line capacity as the main service differentiation approaches used. The results are presented in Table 6.17.

Table 6.17: Service differentiation approaches used (N=12)

| Service differentiation approach | No. of Respondents | % respondents |
|------------------------------------|--------------------|---------------|
| Dial-up connection v/s leased line | 8 | 66.67 |
| High bandwidth v/s Low bandwidth | 12 | 100.00 |
| Guaranteed service v/s best effort | 1 | 8.33 |

6.5.1.3 Service Costing Approaches (N=12)

The most commonly applied service costing approaches are fixed monthly rate and bandwidth dependent variable monthly rate. No other approach was indicated as in use.

Table 6.18, below, shows the distribution of the responses:

Table 6.18: Service Costing approaches (N=12)

| service costing approach | n | % respondents |
|--|----|---------------|
| Number of hours of connection | 7 | 58.33 |
| Fixed monthly rate | 12 | 100.00 |
| Bandwidth dependent variable monthly rates | 10 | 83.33 |

6.5.1.4 Service Level Guarantees

Figure 6.6 indicates that most ISPs (75%) offer some form of service level guarantees to their clients. 17% do not offer the guarantees, while 8% had no response. However, no details were provided on the form of guarantees offered.

Figure 6.6: ISPs offering service level guarantee to users (N=12)

Table 6.19 further indicates the factors considered by ISPs in the provision of Internet services. The findings indicate that all ISPs consider the available bandwidth in the provision of the services. In addition, 58.33% consider link availability, 33.33% consider network reliability, while only 16.67% take network security into consideration.

Table 6.19: Factors considered in offering Internet services (N=12)

| Parameter | n | % of responses |
|---------------------|----|----------------|
| Available Bandwidth | 12 | 100.00 |
| Link Availability | 7 | 58.33 |
| Network reliability | 4 | 33.33 |
| Network security | 2 | 16.67 |

6.5.1.5 Service Level Agreements

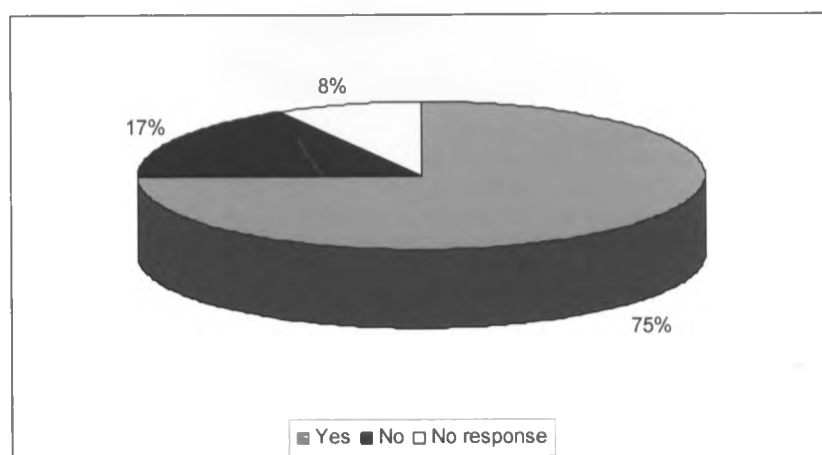
All respondents indicated that the service level agreement specifically indicate the type of services to be offered/supported.

Figure 6.7 further indicates that majority of ISPs require a customer to make an explicit request for any additional service. The remainder indicated that they would require a customer to enter into a new agreement for each additional service. No ISP provides the user with the freedom to run additional services at will.

Figure 6.7: Requirement for new service

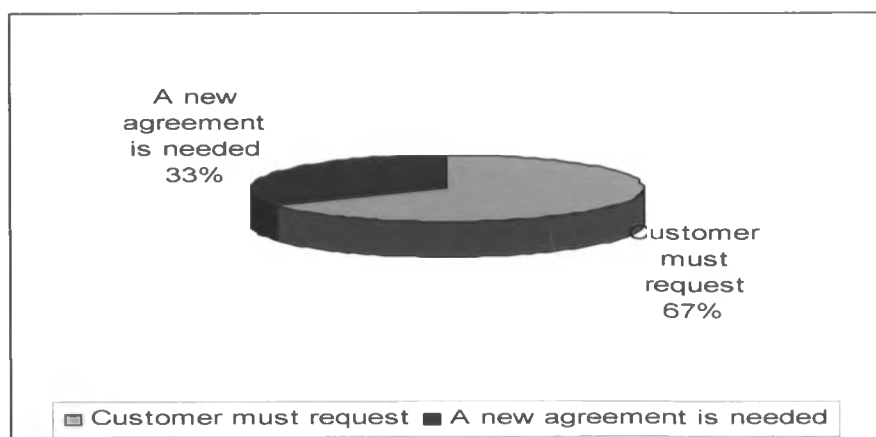

6.5.2 Link type

The section focuses on the different link characteristics. These include: section 6.5.2.1 network infrastructure; section 6.5.2.2 link capacity; and section 6.5.2.3 infrastructure agreement.

6.5.2.1 Network Infrastructure

By the responses received, all ISPs sampled indicated that they offer services both directly and through points of presence.

Figure 6.8, further indicates that 70% of the respondents prefer offering services directly to the customer, while 30% prefer offering services through point-of-presence.

Figure 6.8: Preferred link to customer (N=10)

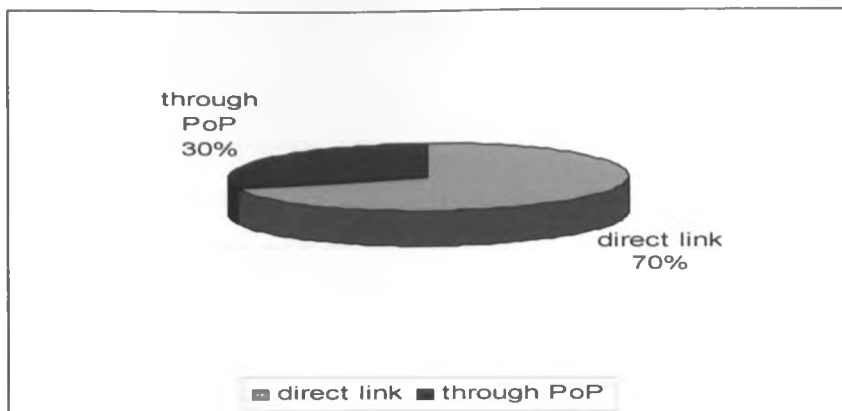

6.5.2.2 Link Capacity

The respondents indicated offering link capacities as follows:

Table 6.20: minimum and maximum link capacities offered

| | Through point of presence (kbps) | Direct link (kbps) |
|-----------------------|----------------------------------|--------------------|
| Minimum link capacity | 32 | 512 |
| Maximum link capacity | 32 | 512 |

6.5.2.3 Infrastructure agreement

Table 6.21 shows the distribution of responses on whether there exists an infrastructure agreement with providers. The respondents indicate that 75% of the ISPs have no such agreements in place; while 25% have some form of agreement in place.

Table 6.21: There exists an infrastructure agreement (N=12)

| | n | % of responses |
|-----|---|----------------|
| No | 9 | - 75.00 |
| Yes | 3 | 25.00 |

6.5.3 Quality of Service

This section seeks to find out the quality of service support by the sample ISPs. It focuses on five aspects: section 6.5.3.1 Quality of Service policy; section 6.5.3.2 support for existing models; section 6.5.3.3 quality of service factors; section 6.5.3.4 limitations to quality; and section 6.5.3.5 opinion on quality.

6.5.3.1. QoS policy

The respondents were asked whether they have in place a quality of service policy. 17% of respondents indicated having a quality of service policy in place, while the 50% has no such policy. This shows that majority of ISPs have not yet considered quality as part of their service specification.

Figure 6.9 shows the split of responses on availability of a policy on quality of service.

Figure 6.9: Availability of QoS policy (N=12)

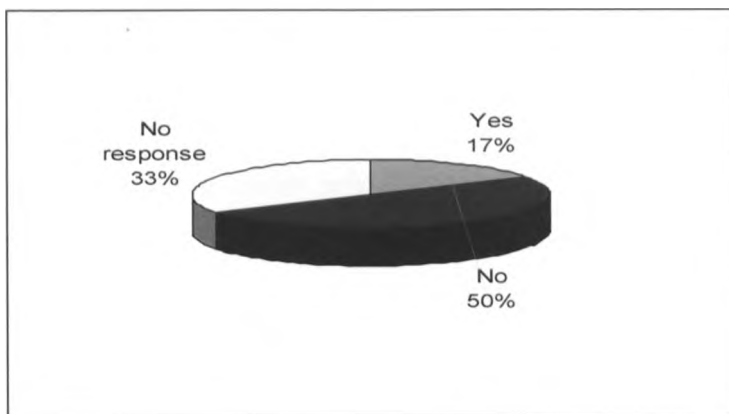

6.5.3.2. Support for existing models

Resource allocation is indicated as the most common approach in improving service reliability. Further, the Integrated services model (Intserv.) with RSVP is the service model supported by most ISPs.

Table 6.22 indicates that majority of ISPs (83.33%) provide support for Intserv, 25% support Differentiated Service model (Diffserv.), while 16.67% support the multi-protocol label switching model (MPLS):

Table 6.22: Support for existing QoS models (N=12)

| Model | n | % of responses |
|----------|----|----------------|
| Diffserv | 3 | 25.00 |
| Intserv | 10 | 83.33 |
| MPLS | 2 | 16.67 |

6.5.3.3. QoS Factor:

The respondents further indicated bandwidth as the main factor considered in the implementation of QoS. 100% of the respondents would consider bandwidth while only 16.67% (2) would consider delay variation. No other factor was indicated for consideration.

6.5.3.4. Limitations to quality

The respondents were asked what they view as the limitations to the implementation of quality Internet services in Kenya. The following are the factors, as per the responses:

- Poor infrastructure
- Availability of bandwidth.
- Cost of available bandwidth.
- Cost of investing in quality infrastructure.

6.5.3.5. Opinion on Quality

All respondents had the following opinion on the Internet services in Kenya:

- The Internet services meet the minimum quality requirements.
- The Internet infrastructure in Kenya does not support QoS implementation.

Chapter 7: Proposed Framework

7.1 Introduction

The key to the implementation of Internet Quality of Service is a QoS model. The model defines the services, service parameters and service levels acceptable for a quality service.

The “**Kenya Internet Quality of Service (KiQoS)**” model, proposed in this study, represents a framework on which Quality of Service can be requested, offered and judged within the Kenyan Internet market.

According to the findings in chapter 6, the Internet users in Kenya can be grouped into three categories on the basis on how they access the Internet services. The first category consists of those who access the Internet services from cyber cafes. This category forms the majority of the users (76%), as per table 6.6. The second category comprises of users who have access to Internet services from their places of work. These, according to the study, form 12% of users. The third category comprises of users who have Internet connection to their computer at home or private premises. This group also encompasses the fast growing number of mobile Internet users.

The objectives of any organization, in the provision of Internet services to its employees, are to service the mission critical applications. These applications form the core business of the given organization and vary from one organization to another. On the other hand, the key objective of a cyber cafe, in providing Internet services, is to maximize on the profit of the enterprise. For an individual, the goal may range from simple messaging and entertainment, to the access to critical and real time data.

Quality of service gives a different meaning to each of these three categories of users. To an organization, quality of service is judged on the success of the mission critical operations (processes) rather than the specific requirement of each individual employee. QoS in business organizations, research institutions, academic institutions and multinationals is thus an aggregation of the performance factors, driven by the mission of the organization.

This category of users is characterized by high data rate connectivity, which is reviewed regularly to provide more capacity and better performance. The institutions have the budgetary capacity to overprovision for their Internet needs.

Cyber cafes in Kenya are typically linked via radio links with capacities of between 128Kbps and 256Kbps. To a cyber cafe entrepreneur, quality of service is a tight balance between customer satisfaction and profitability. The quality of service for applications is a secondary factor, which is driven by the customer's need for a service, rather than a business strategy. The ability to add capacity is limited, and thus over provisioning is not an option.

Users with connectivity to their personal computers, laptops, mobile phones, etc, provide a different view of quality of service. To this group the services they enjoy are essentially enough for the basic Internet access. The need to implement other quality of service measures is then driven by the applications that the user may need to access.

According to figure 6.2, the average link speed in Kenya was found to be 87.6Kbps on the minimum and 272.9Kbps on the maximum.

The proposed framework provides a way in which these three categories of users can implement Internet Quality of Service using the existing infrastructure. It provides a means by which users who wish to subscribe to QoS can make an informed choice, and also for service providers to determine what QoS capabilities they can offer.

According to tables 6.1 and 6.3, the Internet traffic can be either categorized as data, voice or video. These categories are taken into consideration in the proposed framework.

The following observations have also been made, and have been considered in the framework.

- Cost is a key aspect in the provision of Internet services in Kenya. It has served as the key indicator of service differentiation. For example; a dedicated line service client pays more than a dial-up service client, though there is no guarantee of services all the time. This study establishes that Internet users are willing to pay for quality service provided the service level is specified and guaranteed.

- By definition, QoS is judged on the basis of user satisfaction with the service. This implies that the user is the final arbiter of 'good' or 'bad' QoS. Different applications demand different service qualities. The proposed framework presents the different options for implementing QoS for data, voice and video applications.
- QoS only works on upstream/outbound data (data going from you to your ISP). True QoS is thus only possible if it's offered by the Service provider, and understood by the service user. The service level agreement need to be specific on the type of service, parameters to measure, parameter levels and the guaranteed levels.
- Though, QoS sensitive applications, such as VoIP and Video Conferencing, are growing in use in the Kenyan Internet market, table 6.9 indicates that these services are accessed on a once-off (rarely) bases. This study established that the most commonly used Internet Services in Kenya, (including web browsing, electronic mail and file transfer), are quite tolerant to the performance of the best-effort service. In addition, the users are generally patient enough to wait or try another time. This provides little incentive to the subscription to "full time" quality of service.
- In section 6.4, this study established that majority of Internet users (including network administrators) have little or no knowledge of Quality of Service requirements and parameters. Similarly, the Internet users are not conversant with the QoS features supported by their service providers. This makes it difficult to implement the legacy (Diffserv or Intserv) models of service on the Kenyan Internet market.

In the following section, KiQoS model services, and their implementation, are specified based on the Intserv over Diffserv service model, as the above observations.

7.2 Model implementation Components

The provision of end-to-end quality of service is driven by specific objectives that are intended for the network services that are offered. In this framework, five broad QoS objectives are:

- To provide an easier and convenient way of specifying QoS requirements.
- To provide a way of QoS translation and implementation.
- To provide a QoS specification that is independent of the physical link type.
- To implement QoS on the existing network infrastructure.
- To satisfy QoS expectations from the user/application point of view.

Based on the Intserv over Diffserv Service implementation model, the KIQoS shall have ten (10) major components, placed in three categories:

1. Service specification components
2. Service implementation components
3. Service evaluation components

Service Specification Components

- (i) **Application type** – different applications have differing QoS requirements. This identifies the type of applications that each KIQoS service type supports. Three application types are specified: data, voice and video.
- (ii) **Infrastructure** – the ability to support the QoS requirements of any application is dependent on the link capacity of the connection being used, as well as the availability of the necessary bandwidth for communication. Though some applications are tolerant to delay, the KIQoS model describes the minimum requirements on link capacity that will be necessary to achieve sustainable QoS for each KIQoS type of Service.
- (iii) **User environment** – access to Internet services can occur within a dedicated or shared user environment. For example, if an organization wishes to provide video conferencing services to its employees, it is essential to determine how

many sessions can take place concurrently. This also has an impact on the infrastructure requirements.

Service Implementation Components

- (iv) *Intserv Component* – this provides a specification on the Intserv/RSVP configurations recommended for each service. It also provides the reservation limits as well as the typical bandwidth split for the services.
- (v) *Diffserv Component* – this gives the required DSCP mappings for each of the services offered.
- (vi) *Parameters* – this specifies the parameters to be considered as well as the targets for the parameters.
- (vii) *Special hardware or software* – some services require the use of special hardware or software. Codecs are needed for both voice and video services. Network accelerator/optimizing software may also be used.

Service Evaluation Components

- (viii) *User satisfaction* – this takes into account the user's perception of the service provided, as compared to the service that was requested. It serves as a basis for evaluating the success of the QoS implementations.
- (ix) *Infrastructure* – changes in infrastructure may affect the service offered. To implement new applications, or improve existing services, it is necessary to review the capacity provided by the infrastructure.

The interaction between the model components is described in figure 7.3.

7.3 The KiQoS Services

To achieve the specified service objectives, three Service classes are proposed, each with specific QoS objectives. Namely:

1. Type1 QoS (KiQoS Basic) –for data only services.
2. Type2 QoS (KiQoS Premium) – for networks that carry voice traffic over the data network.
3. Type3 QoS (KiQoS Assured) – for data networks requiring support for voice and video traffic.

In addition, Six service types are proposed, corresponding to the service classes. The service classes and types are summarized in figure 7.2 below.

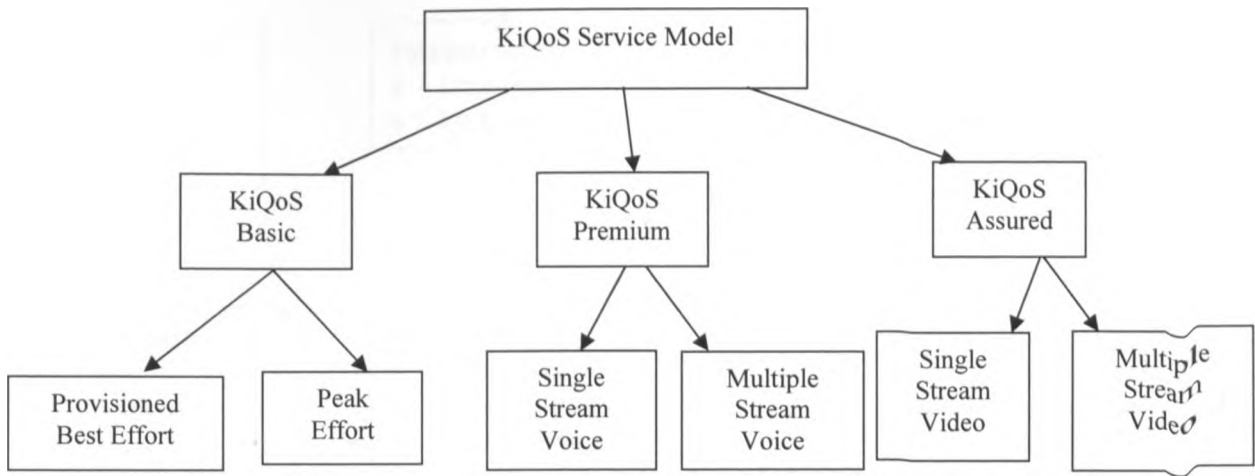

Figure 7.2: The KiQoS model services

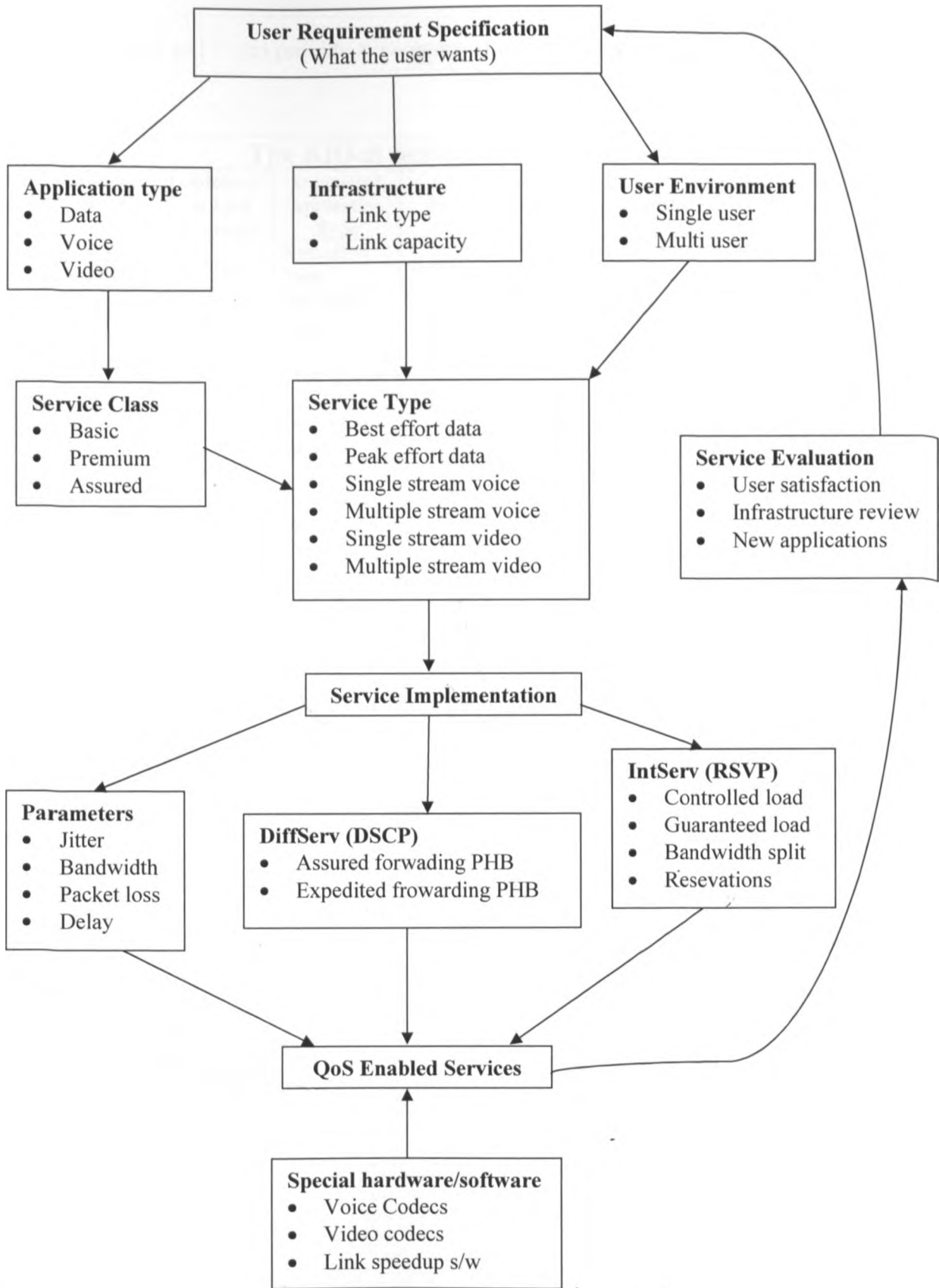

Figure 7.3 The KIQoS model components Interaction

Table 7.1 (a), 7.1(b) and 7.1(c) provide a summary of the KIQoS model, components and Services.

| The KiQoS Service Model- Type1 | | | | | | |
|---------------------------------------|--------------------------------|------------------------------|-----------------------------------|---------------------------|-------------------------|---|
| Service Class | Service Type | minimum Link Capacity | Supported Application Type | Service Parameters | User Environment | Service Configuration |
| KiQoS Basic | Provisioned Best Effort | 64kbps | Best effort Data | Bandwidth | Single user | - DHCP default PHB |
| | Two-tier Peak Effort | 64kbps | Best effort Data | Bandwidth | Multi user | - DHCP default PHB |
| | | | Priority data | - Delay - Packet loss | Multi user | - DHCP PHB AF11 - Controlled load (RSVP) |
| | Four-tier Peak Effort | 128kbps | Best effort data | Bandwidth | Multi user | - DHCP default PHB |
| | | | Interactive data | - Delay - Packet loss | Multi user | - Controlled load (RSVP) - DHCP PHB AF31, AF32, AF33 |
| | | | Critical data | - Delay - Packet loss | Multi user | - Controlled load (RSVP) - DHCP PHB AF21, AF22, AF23 |
| | | | Bulk data | - Delay - Packet loss | Multi user | - Controlled load (RSVP) - DHCP PHB AF11, AF12, AF13 |

Table 7.1(a) The KIQoS Service Model - KIQoS type1 service

| The KiQoS Service Model-Type2 | | | | | | |
|--------------------------------------|------------------------------|------------------------------|-----------------------------------|---------------------------|-------------------------|---|
| Service Class | Service Type | minimum Link Capacity | Supported Application Type | Service Parameters | User Environment | Service Configuration |
| KiQoS Premium | Single Stream Voice | 128kbps | Best effort data | Bandwidth | Multi user | - DSCP default PHB |
| | | | Critical data | - Delay - Packet loss | Multi user | - Controlled load (RSVP) - DSCP PHB AF21, AF22, AF23 |
| | | | Bulk data | - Delay - Packet loss | Multi user | - Controlled load (RSVP) - DSCP PHB AF11 |
| | | | Voice messaging | - Delay - Packet loss | Multi user | - Controlled load (RSVP) - DSCP PHB AF31, AF32, AF33 |
| | | | VoIP | - Delay - Jitter | Single user | - Guaranteed (RSVP) - DSCP EF PHB - G.729A codec |
| | Multiple Stream Voice | 256kbps | Best effort data | Bandwidth | Multi user | - DSCP default PHB |
| | | | Critical data | - Delay - Packet loss | Multi user | - Controlled load (RSVP) - DSCP PHB AF21, AF22, AF23 |
| | | | Bulk data | - Delay - Packet loss | Multi user | - Controlled load (RSVP) - DSCP PHB AF11 |
| | | | Voice messaging | - Delay - Packet loss | Multi user | - Controlled load (RSVP) - DSCP PHB AF31, AF32, AF33 |
| | | | VoIP | - Delay - Jitter | Multi user | - Guaranteed (RSVP) - DSCP EF PHB - G.711 or G.729A codec |

Table 7.1(b) The KIQoS Service Model - KIQoS type2 service

| The KiQoS Service Model-Type3 | | | | | | |
|--------------------------------------|------------------------------|------------------------------|-----------------------------------|---------------------------|-------------------------|---|
| Service Class | Service Type | minimum Link Capacity | Supported Application Type | Service Parameters | User Environment | Service Configuration |
| KiQoS Assured | Single Stream Video | 512kbps | Data traffic | - Delay - Packet loss | Multi user | KiQoS peak effort |
| | | | Voice | - Delay - Jitter | Multi user | KiQoS Premium service |
| | | | Streaming video | - Packet loss | Single user | - DSCP CS4 - Controlled load (RSVP) |
| | | | Interactive video | - Packet loss | Single user | - DSCP PHB AF41 - Controlled load (RSVP) |
| | Multiple Stream Video | 1024kbps | Data traffic | - Delay - Packet loss | Multi user | KiQoS peak effort |
| | | | Voice | - Delay - Jitter | Multi user | KiQoS Premium service |
| | | | Streaming video | - Packet loss | Multi user | - DSCP CS4 - Controlled load (RSVP) |
| | | | Interactive video | - Packet loss | Multi user | - Controlled load (RSVP) - DSCP PHB AF41, AF42, AF43 |

Table 7.1(c) The KiQoS Service Model – KiQoS type3 service

7.3.1 Type1 QoS – KiQoS Basic

Type1 QoS provides network services with guarantee on throughput and minimum packet loss. It represents an option for providing QoS enabled services over low speed links of up to 128kbps. Users who intend to subscribe to Internet Quality of Service on data only networks, can choose one of the Type1 QoS services.

Type1 QoS has the following quality of service objectives:

- Packet loss rates $< 10^{-6}$
- One-way delay $< 2s$ for interactive traffic, $< 60s$ for bulk traffic and $< 4s$ for other traffic.

a. Provisioned Best Effort Service

One way of providing Network QoS is to provide extra capacity, such that the possibility of loss, delay and congestion is considerably reduced. The provisioned best effort service is just best effort service offered over a link with extra capacity. Users can achieve this level of service by subscribing to more bandwidth than they intend to use.

b. The Peak effort service

This is a data only service, meant for applications that can perform under best effort service, but where users require guarantee on delay and loss parameters. It provides for preferential treatment of some of the data traffic that is mission critical to the individual or organization.

The peak effort service can be implemented as two-tier on a 64kbps link, or as four-tier on a 128kbps link, with the specifications recommended in section 7.4.

7.3.2 Type2 QoS – KiQoS Premium

The *KiQoS Premium Service* is a high throughput service meant for networks that support voice transmission on the data network. Voice traffic is sensitive to delay and jitter and thus Type2 QoS provide guarantees based on these two. It also provides guarantee on minimum packet loss rate.

The service is based on the Intserv's guaranteed service and DifServ's premium service. This ensures that packets are not dropped due to network congestion.

The Type2 QoS has the following quality of service objectives:

- One way delay $< 150ms$
- Packet loss rate (PRL) $< 1\%$
- Delay variation (one-way jitter) $< 30ms$

The service can be implemented on links with a capacity of atleast 128kbps with either a single voice stream or multiple voice streams supported. The implementation specifications are given in sections 7.4.3 and 7.4.4 below.

7.3.3 Type3 QoS – KiQoS Assured

The *KiQoS Assured Service* – This is a high data rate and low loss service meant for networks that support video applications. It is based on the Diffserv's Assured service and Intserv's Controlled load service, thus it is suitable for applications that are sensitive to loss, but not sensitive to delay. It provides no guarantees on delay.

The Type3 QoS has the following quality of service objectives:

- One way delay < 150ms for video Conferencing and <5s for streaming video
- Packet loss rate (PRL) < 1%
- Delay variation (one-way jitter) < 30ms

The service may be implemented on a link of 512kbps or higher, with the specifications recommended in section 7.4.5 below.

7.4 KiQoS Service Implementation

7.4.1 Implementing Two-tier Peak Effort

The recommended minimum link capacity for this service is 64kbps.

Under this service, the data traffic is classified into two classes:

- Priority data
- Best effort data

The Intserv router implements RSVP with maximum reserved bandwidth as 48kbps, and maximum bandwidth per reservation as 24kbps. Intserv's controlled load service is used to map the priority data, while the rest of the data is treated as best effort. A maximum of two reservations can be supported on the link at any given time, while 25% of the link capacity (16kbps) remains unmapped at any given time. This ensures non-starvation for best effort data.

Default mapping is used to map between the RSVP on the Intserv router and the DSCP PHB on the Diffserv edge device.

DSCP Assured Forwarding PHB is used on the edge device, with drop precedence set to AF11 (001010) for priority data, while all other traffic is mapped to default PHB (000000).

Figure 7.4 (a) and (b) illustrates the implementation of the two-tier peak effort service.

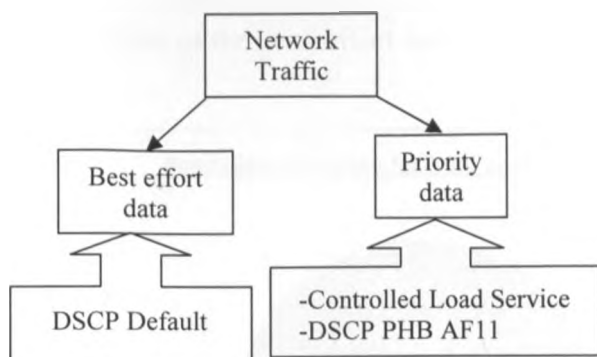

Figure 7.4 (a): Two-tier peak effort service definition

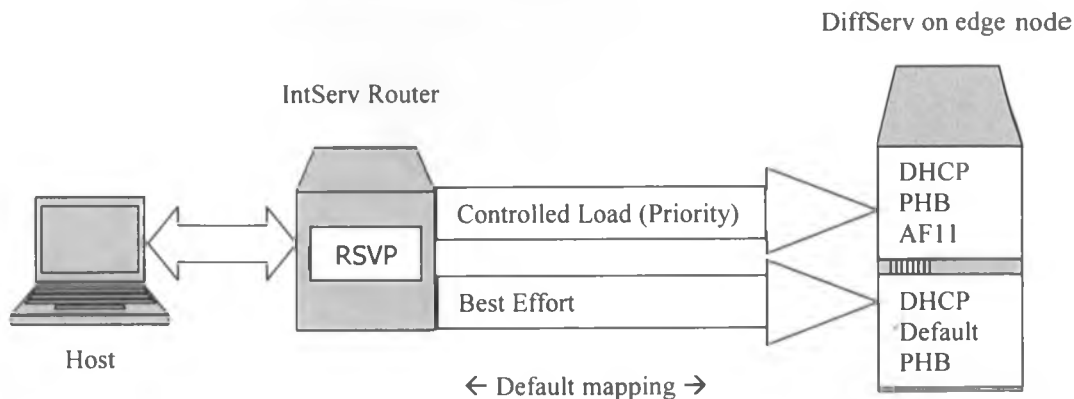

Figure 7.4 (b): Two-tier peak effort service implementation

7.4.2 Implementing Four-tier Peak Effort:

The recommended minimum link capacity for this service is 128kbps.

Under this service, the data traffic is classified into four service classes:

- Best effort data
- Interactive/transactional data
- Critical data
- Bulk data.

The Intserv router implements RSVP with maximum reserved bandwidth as 96kbps and maximum bandwidth per reservation as 24kbps. As with two-tier peak effort, Intserv's controlled load service is used to map the different service classes. 64kbps is reserved for critical data, 20kbps for interactive data, 12 kbps for bulk data, while 25% of the link capacity (32kbps) remains unmapped at any given time. Figure 7.5 summarizes the bandwidth split for a four-tier implementation of the peak effort service, over a 128kbps link capacity.

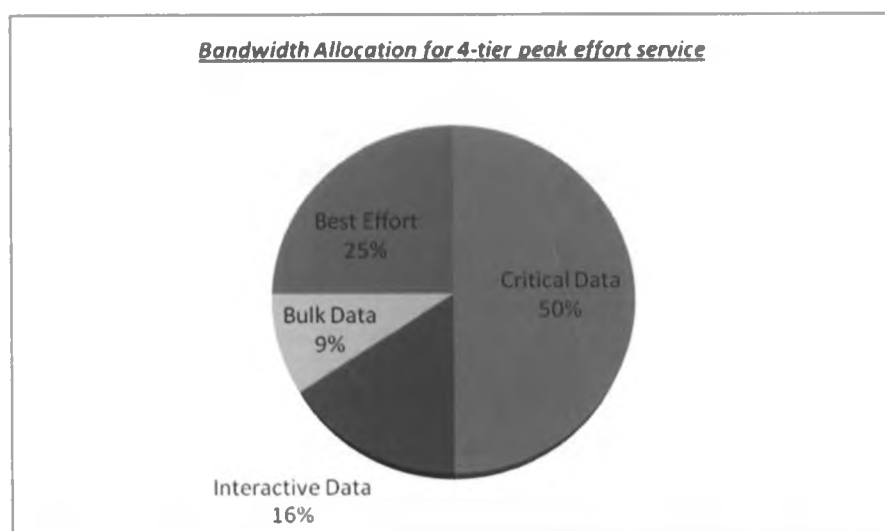

Figure 7.5: Bandwidth allocation on a 128kbps link

DSCP Assured Forwarding PHB is used on the edge device, with drop precedence set as follows:

- Critical data - AF21 (010010), AF22 (010100) or AF23 (010110) depending on the desired priority.
- Interactive data – AF31 (011010), AF32 (011100) or AF33 (011110).
- Bulk data – AF11 (001010), AF12 (001100) or AF13 (001110)
- Best effort data – Default PHB (000000).

The mapping is illustrated in figure 7.6 below:

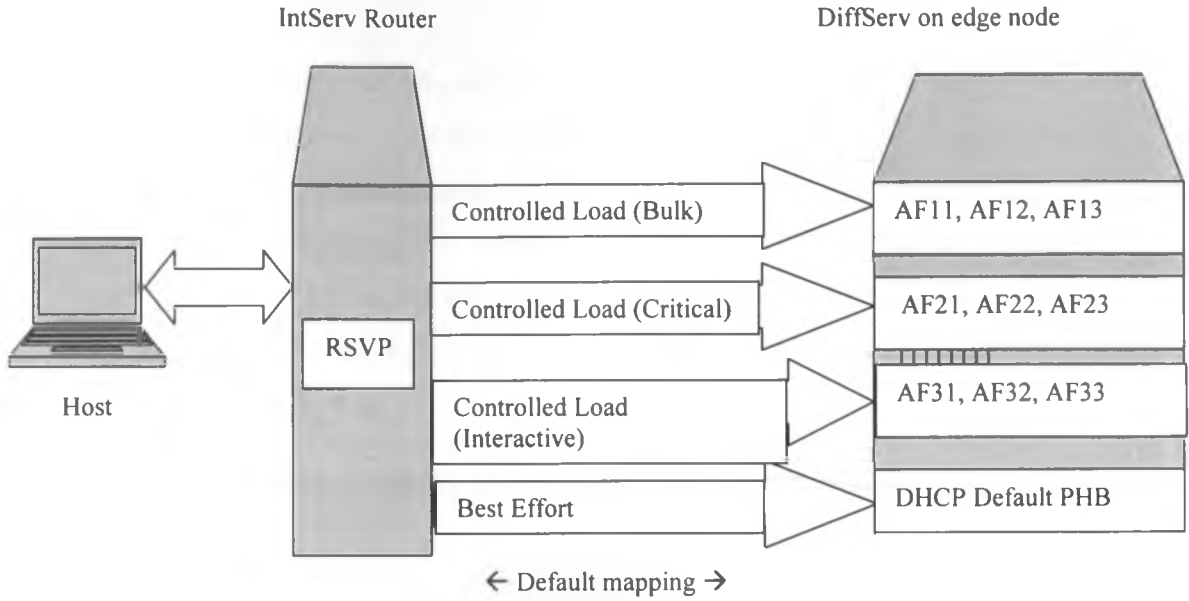

Figure 7.6: Four-tier peak effort service implementation

7.4.3 Implementing Single stream Voice Service

The minimum link capacity recommended for this service is 128kbps.

The service supports a single voice session at a time, over the data network. The data on the network may be implemented as just best effort, or with peak effort service. The voice data is separated into Voice over IP (interactive real time) and voice messaging (non real time). Figure 6.7 shows the proposed traffic categorization under this service.

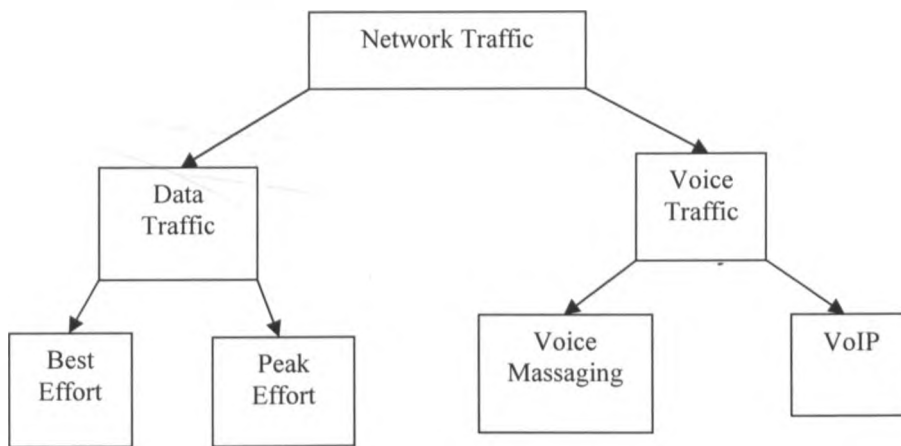

Figure 7.7: Traffic Categorization under the premium service

The Intserv router implements RSVP with maximum reserved bandwidth as 96kbps, and maximum bandwidth per reservation as 32kbps. The voice traffic is mapped to Intserv's guaranteed service at the router, while controlled load is used for critical data traffic. Other traffic is mapped to best-effort. 64kbps is reserved for Voice traffic, 32kbps for data traffic, while 25% of the link capacity (32kbps) remains unmapped at any given time to be used by best effort traffic. This is illustrated in Figure 7.8.

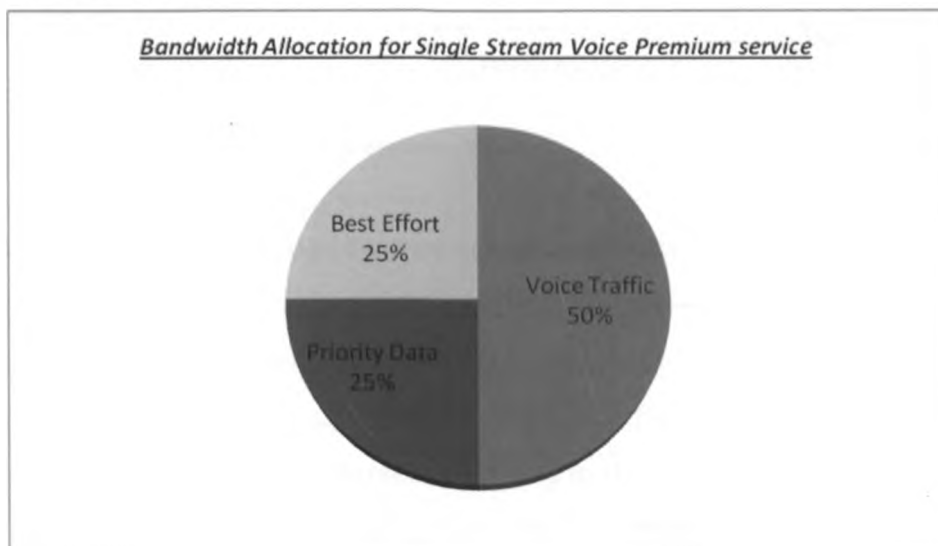

Figure 7.8: Recommended bandwidth split for single stream voice

At the Diffserv edge node, DSCP expedited forwarding PHB EF(101110) is used for VoIP traffic, while AF31 is used for voice control data. Voice messaging traffic can then be assigned to AF32 and AF33. The critical data is mapped to DHCP AF21, AF22 and AF23 depending on the drop precedence required, while AF11 is used for bulk data. See figure 7.9 below.

The use of a low-bit-rate, frame based voice codec, such as G.729A, is recommended. This ensures a maximum reserved bandwidth of 32kbps per VoIP session, allowing more bandwidth for control and messaging voice traffic.

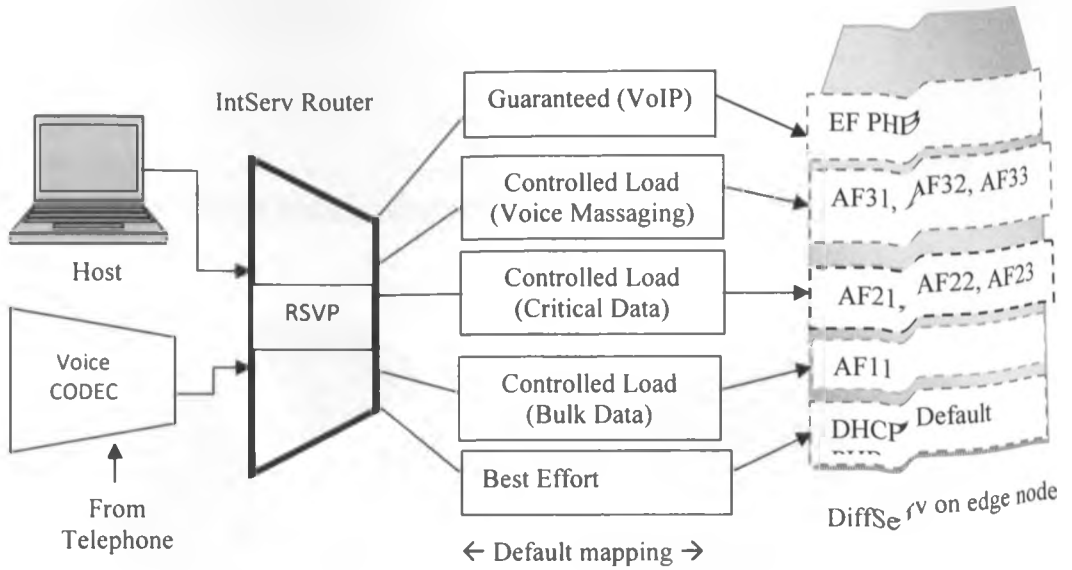

Figure 6.9: Single voice stream premium service

7.4.4 Implementing multiple voice stream service on a 256kbps link:

The minimum link capacity recommended for this service 256kbps.

The service supports two or more voice sessions at a time, over the data network. The number of sessions supported will depend on the link capacity and the coding algorithms used. The data classification is as in figure 7.7, and the implementation is similar to the single stream voice service specified in section 7.4.3 above, except for two differences:

- (i) The amount of bandwidth allocated for each type of traffic is larger. In this implementation the maximum reserved bandwidth is set to 192kbps and the maximum bandwidth per reservation is 80kbps. For implementations using low-bit-rate codec, the maximum bandwidth per reservation can be set to 32kbps. This allows for more reservations.
- (ii) The service can support the use both waveform codec such as G.711 series, and the low-bit-rate, frame based codec such as the G.729 series. This allows the maximum bandwidth required per VoIP session to be 80kbps, using a sampling rate of 20ms or 30ms on the codec.

For a link with a 256kbps capacity, 160kbps may be reserved for Voice traffic, 32kbps for data traffic, while 64kbps remains unmapped at any given time to be used by best effort traffic, as shown in figure 7.10

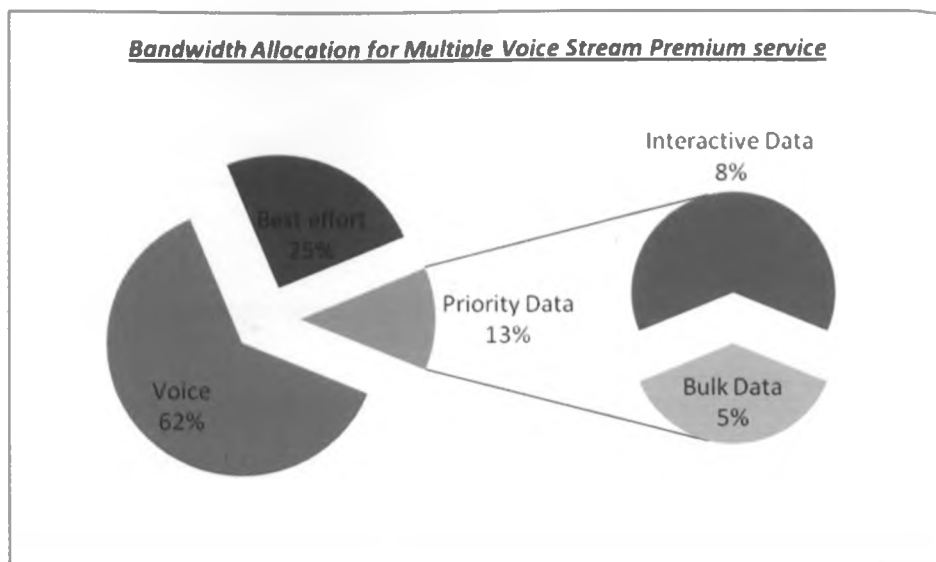

Figure 7.10: Percentage bandwidth allocation in multiple stream voice service

Table 7.2 shows the number of simultaneous VoIP sessions that are possible on a 256kbps link, based on the commonly used voice codec, with the above specifications:

| CODEC | Sampling Interval (ms) | Bandwidth requirement per VoIP session | Maximum number of VoIP sessions |
|-------|------------------------|--|---------------------------------|
| G.711 | 20 | 80kbps | 2 |
| G.723 | 30 | 23kbps | 6 |
| G.726 | 20 | 48kbps | 3 |
| G.728 | 30 | 32kbps | 5 |
| G.729 | 20 | 24kbps | 6 |

Table 7.2: Number of simultaneous VoIP sessions at a time on a 256kbps link

7.4.5 Implementing KiQoS Assured Service:

Video traffic is generally bulky and bursty in nature. The recommended minimum bandwidth for this service is 512kbps one way (512kbps uplink and 512kbps downlink). More bandwidth is required if more than one Video Conferencing session is to be supported at a time.

Video traffic exists in two main types: interactive video (Video Conferencing) and streaming video (both unicast and multicast).

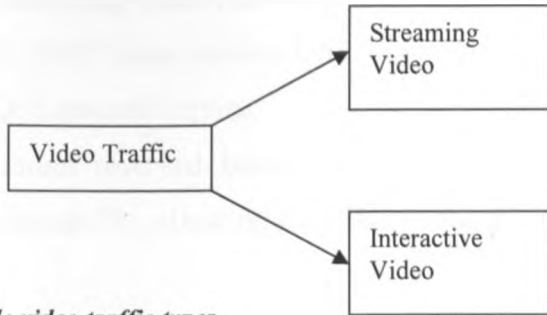

Figure 7.11: video traffic types

Assured service may be implemented as single stream video or multiple stream video. Single stream video is meant for environments where only one video conferencing session is allowed at a time. In cases where multiple video conferencing sessions are expected, the multiple stream video assured service is required. In this case, at least 1Mbps link is required. Other than this capacity difference, the implementations are similar.

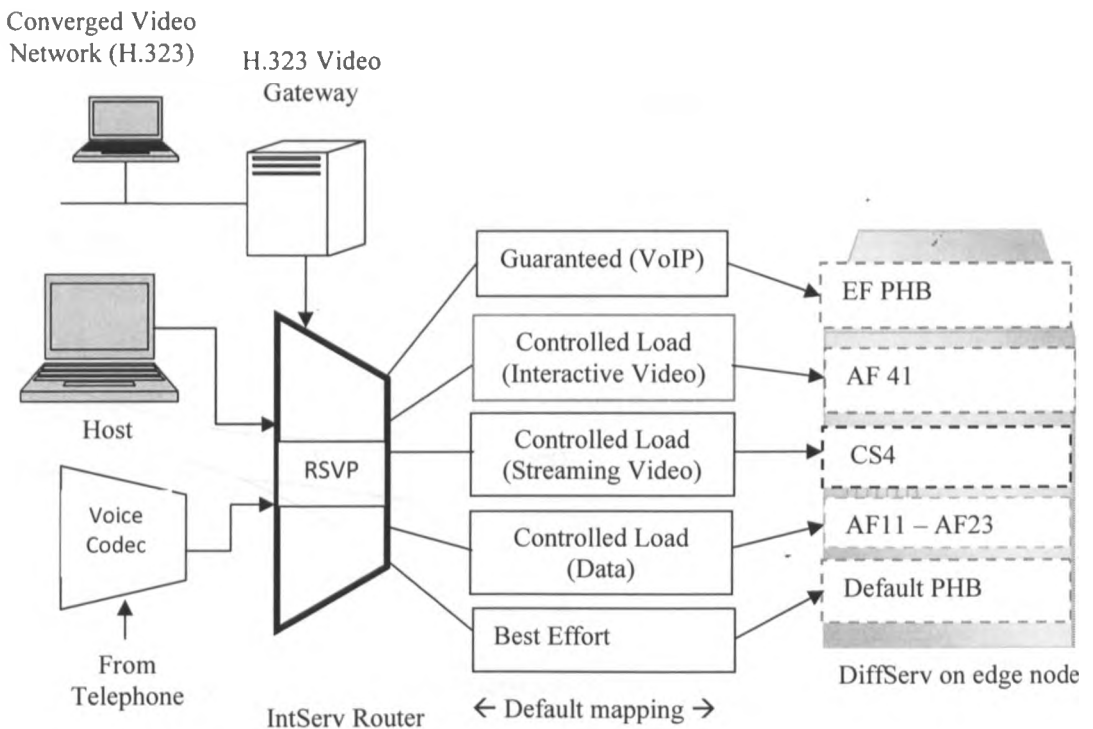

Figure 7.12: KiQoS Assured Service

DSCP assured forwarding PHB with AF41 (100010) is used for the interactive video traffic, while the streaming video is set to DSCP class selector CS4. Non essential streaming video (scavenger) traffic, such as entertainment video, can be mapped to DSCP class selector CS1. Figure 6.12 shows a typical implementation of the KiQoS assured service.

The maximum reserved bandwidth is set to 384kbps is reserved for Video Conferencing traffic, allowing for 128kbps for other applications to share.

7.5 Framework Validation:

The model was validated to ascertain its suitability in the provision of Internet Quality of Service. Regression analysis was used to test the suitability of the model.

The research model on requirement specification, when subjected to regression analysis yielded an R2 value of 0.926, indicating a good theoretical model.

| Model | R | R Square | Adjusted R Square | Std. Error of the Estimate |
|-------|---------|----------|-------------------|----------------------------|
| 1 | .962(a) | .926 | .896 | .36 |

a Predictors: (Constant), Application type, User Environment, Link Type, Bandwidth

Figure 7.13: Regression Model Summary on service specification

The regression coefficients for the service type determination construct based on our model were determine as shown in figure 7.14 below.

| Dependent | Beta | Significant value (Sig.) | Comment |
|------------------|-------|--------------------------|-----------------------|
| Bandwidth | .897 | .000 | There is influence |
| Application type | .951 | .000 | There is influence |
| Link Type | -.745 | .001 | There is influence |
| Access Point | .331 | .227 | There is no influence |

Figure 7.14: Regression Coefficients for service type determination

The constructs bandwidth, application type and link type exhibited a significant influence on service type determination, with a significant value < 0.05. The

access point (or environment of access) however did not exhibit influence on service determination. This can be attributed to the fast changing Internet user environment in Kenya, where users have access to Internet services via wireless devices, from hotels, airports, and hotspots within metropolitan regions.

Due to the technical nature of the service implementation constructs of our framework, it was not possible to validate the model based on user perception, thus it validated on the basis of conformity to established standards, the existing models and frameworks, as well as the basic requirements for quality of service for different Internet applications. The framework was found to conform to the existing market standards with respect to bandwidth, packet loss rates, delay and jitter parameters, as specified by the IETF standards. It further provides simplicity in the determination of the parameters, parameter levels and infrastructure specifications for each service type, making it an easy to implement model.

Chapter 8: Conclusion and Recommendation

8.1 Introduction

The purpose of this study was to establish the extent to which Quality of Service is implemented in the provision of Internet services in Kenya. It also sought to establish the suitability of the existing models, particularly Diffserv and Intserv, as a means of implementing QoS, as well as the parameters used to measure quality.

Finally the researcher endeavored to develop a framework, which can be used in the implementation of Internet QoS in Kenya.

8.2 Conclusion

The overall objective of this study was to come up with a, proposed, framework, for use in the implementation of Internet QoS in Kenya. In addition, the study had five specific objectives, all of which were satisfactorily met.

The first objective of the study was to establish if there is currently a QoS measure, in the provision of Internet services in Kenya. The researcher established that there is no QoS measure, currently being implemented in the Kenyan Internet market.

The second objective was to determine the applications that are sensitive to QoS. The study established that, in addition to web content browsing, electronic mail and file transfer, applications such as voice over Internet Protocol (VoIP) and Video Conferencing are growing in popularity amongst Kenyan Internet users. These two applications were identified as the main QoS sensitive applications in the market. Other key applications include distance education, multimedia desktop collaboration and video surveillance.

The third objective was to determine the key considerations in determining user satisfaction for a network model in Kenya. It was established that, bandwidth, cost and availability are the key determinants of Internet quality in Kenya. There is little understanding on the need and application of other parameters, such as loss, delay and jitter. In addition, it was established that Internet users in Kenya are generally not aware of their entitlement to QoS.

The fourth objective was to determine whether the existing QoS models are applicable to the Kenyan scenario. The researcher established that, though the Kenyan Internet market has its uniqueness, it is possible to implement Internet QoS based on the existing models. The KiQoS model proposed in this study is actually based on the Diffserv and Intserv models.

The fifth objective was to determine how Internet users in Kenya access the services. The study established that majority of Internet users access the services from cyber cafes (76%). The other users access the services, either from work place (12%) or from personal computers with Internet connectivity (24%).

In addition to meeting the specified objectives, the study also established that there is no legal or policy framework in place, to govern the provision of Internet services in Kenya. Also, there is very little documentation on the Internet services in Kenya. This was a major challenge to the researcher in this study. This study is thus expected to add to the available literature in the area.

During the study, the researcher encountered unwillingness, on the part of service providers, to provide necessary information on the services provided.

8.3 Recommendations

The study was limited to the service description, leaving out the technical aspects of the implementation. The researcher thus recommends further study on the cost and technical implications of the model implementation.

It is also anticipated that, with the commissioning of the undersea cable, the Internet environment in Kenya will change. I thus recommend that further study can be done on the adaptation of the KiQoS model, on the new infrastructure.

The researcher also recommends that the findings of this study, particularly the proposed framework, be implemented as part of coming up with a policy framework to govern Internet QoS in Kenya. In addition, appropriate legal and policy guideline, for the implementation, need to be put in place by the market regulator (CCK). This should also form the basis for further study in the subject.

APPENDIX A: REFERENCES

1. Andrew S. Tanenbaum: *Computer Networks 4th Edition*; Pearson Education inc., 2004.
2. Andreas Vogel, Brigitte Kerhervé, Gregor von Bochmann, Jan Gecsei: *Distributed Multimedia and QoS: A Survey*; IEEE MultiMedia, 1995.
3. Avinash Tadimalla: *Quality of Service (QoS) Primer*, Cisco Systems, 2006.
4. Bernet, Y., et. Al.: *A framework for integrated services operation over Diffserv networks*; RFC 2998, Internet Engineering Task Force (IETF), November 2000.
5. Brent Wilson: *QoS Implementation Guide on Cisco Routers*, Network Consulting, 2001.
6. *CCK Policy Guidelines on the Provision of Voice over Internet Protocol (VoIP) Services in Kenya*; CCK 2002.
7. Chengzhi Li, Almut Burchard, Jörg Liebeherr: *A Network Calculus with Effective Bandwidth*, University of Virginia, 2003.
8. Chi-Huang Shih, Chung-Chih Liao: *A transparent QoS Mechanism to support Intserv/Diffserv Network*; National Cheng Kung University, Taiwan, 2002.
9. Cisco Systems: *Implementing QoS Solutions for H.323 Video Conferencing over IP*, 2005.
10. Cisco systems: *Multiprotocol Label Switching (MPLS) Traffic Engineering*; 2003.
11. Francisca Mweu: *Overview of the Internet in Kenya*; Telkom Kenya Limited, 2000.
12. Gerard Bos: *QoS support using Diffserv*, University of Twente, 2007.
13. ITU-T Recommendation E.800 - *Terms and definition related to quality of service and network performance including dependability*, 1994.
14. John Vicente, Michael Kounavis, Daniel Villela, Michah Lerner, Andrew Campbell: *Programming Internet Quality of Service*, Columbia University, NY, USA, 2000.
15. Lancop: *Deliver Quality Of Service Using The Diffserv Model*, Lancop, Inc., 2008.
16. Michael Malakata: *Rival fiber-optic cables set for market battle in Africa*; Computerworld Zambia, 2009.
17. Gil Hansen: *Quality of Service (QoS)*; Object Services and Consulting, Inc. 1997
18. Kanaka Juvva: *Quality Of Service*; Carnegie Mellon University, 1998
19. Peng Hwa Ang, Berlinda Nadarajan: *Issues in the Regulation of Internet Quality of Service*, Nanyang Technological University Singapore and National Computer Board Singapore, 2001.
20. Peter Fishburn and Andrew Odlyzko: *Dynamic Behavior of Differential Pricing and Quality of Service Options for the Internet*; AT&T Labs Research, 1998.
21. Procurve Networking: *Low-Latency Queuing Configuration Guide*; Hewlett-Packard Development Company, 2005.
22. Ruediger Zarnekow, Walter Brenner, Malte Dous, *Quality of Service Business Models for the Broadband Internet*; University of St. Gallen, Switzerland 2006.
23. Sarat Chandra, *QoS in VoIP*; November 28, 2004.

24. Subha Dhesikan: *Quality of Service for IP Videoconferencing*, Cisco Systems, 2001.
25. Tim Szigeti, Christina Hattingh: *Quality of Service Design Overview*, Cisco Press, 2004
26. Timothy M. O'Neil: *Network-Based Quality of Service for IP Video Conferencing*; Polycom Inc. 2002.
27. Vasu Jolly, Shahram Latifi: *An overview of mpls and constraint based routing*, University of Nevada, Las Vegas, USA, 2002.
28. Vuong Son and Xizheng Shi: *A proportional Differentiation Service model for the Future Internet Defferentiated Services*; University of British Columbia, 2000.
29. Waema T., Kashorda M., Kyalo V.: *Kenya Internet Market Analysis Study, Final Report*; Communications Commission of Kenya, 2007.
30. Weibin Zhao, David Olshefski and Henning Schulzrinne: *Internet Quality of Service: an Overview*, Columbia University, 2001.
31. Wojciech B., Halina T., Beben A., and marek D.: *Overview of the QoS framework for EuQoS*; Warsaw University of Technology, Warsaw, 2005.
32. Xiping Guo, Colin Pattinson: *Quality of Service Requirements for Multimedia Communications*; School of Computing, Leeds Metropolitan University, 1997.
33. Xiping Guo, Colin Pattinson: *Quality of Service Requirements for Multimedia Communications School of Computing; Leeds Metropolitan University, 1997*
<http://www.hiraeth.com/conf/web97/papers/guo.html>
34. Zheng Wang: *Internet QoS-Architectures and Mechanisms for Quality of Service*; Morgan Kaufmann, 2001.
35. <http://www.voip-calculator.com/bandwidth.html>: Bandwidth requirements for Voice over IP transmissions, 2008.
36. <http://forums.speedguide.net/showthread.php?t=191804>: Bandwidth Requirements for Video Conferencing; 2005
37. <http://www.cisco.com/warp/public/105/video-qos.html>: Implementing QoS solutions for H.323 Video Conferencing over IP, 2006.
38. <http://www.cisco.com/univercd/cc/td/doc/cisintwk/intsolns/qosoll/qosvoip.htm>: Quality of Service for Voice over IP, 2008.
39. http://www.cisco.com/univercd/cc/td/doc/cisintwk/ito_doc/qos.htm: Quality of Service (QoS), 2007.
40. African Telecommunication/ICT Indicators 2008: At a crossroads; <http://www.itu.int/ITU-D/ict/publications/africa/2008/index.html>
41. What Future Holds for Satellite Internet in Kenya; <http://fortysouth.com/tag/undersea-fiber/>
42. Africa undersea cables; <http://manypossibilities.net/african-undersea-cables/>

APPENDIX B: COVER LETTER

Nicholas Kibaara Riungu,
c/o School of Computing and
Informatics,
University of Nairobi.
E-mail:
nickriungu@yahoo.co.uk

August 23, 2010

Dear respondent,

RE: DATA COLLECTION FOR ACADEMIC PURPOSE

I am a Masters student at the school of Computing and Informatics, University of Nairobi. As part of the course requirements, I am carrying out a study of the nature and state of Internet services in Kenya with the aim of coming up with a proposed framework for Quality of Service implementation. Of interest in this study, is the type and level of service offered (by service providers), and the desired or expected level of service (by the users).

The study is purely for academic purposes, as partial fulfillment of the requirement for the Master of Science degree in Computer Information Systems, at the University of Nairobi.

I wish to request your assistance, in achieving the said goal, by completing the attached questionnaire.

The accuracy and completeness of the information provided is of utmost importance. Once again I wish to assure the respondent that any information provided shall not be divulged to any third party, and shall only be used for the intended purpose.

Thank you for your cooperation.

Yours Sincerely

Nicholas Kibaara Riungu

APPENDIX C: QUESTIONNAIRE 1

1. Target Respondent

This questionnaire is meant for Internet service users.

2. Objectives

- a. To determine users' level of awareness on Quality of service.
- b. To determine the users' desired costing model.
- c. To determine the users' view of the Internet services as offered currently.
- d. To determine the type of connection/link used by users.
- e. To determine the most common internet-based user applications in Kenya.
- f. To determine the key parameters from a users' point of view.

3. Questionnaire structure

This questionnaire is divided into five (5) sections. Each of the section tries to address a critical area of the required information.

- a. Personal details.
- b. Internet infrastructure.
- c. Internet services.
- d. Quality of service.
- e. Additional remarks.

4. Mode of delivery/ presentations

For the purposes of presenting the questionnaire to the respondent, and receiving the response, the following approach shall be adopted:

- a. A random sample of Fifty (50) Internet service users will be selected.
- b. A test run will be conducted on five (5) of the non-selected users.
- c. Collections and alterations may be made based on the results of the test run.
- d. A copy of the questionnaire shall be delivered, manually, to each of the chosen respondents.
- e. The completed questionnaires shall be collected, after seven days, for analysis.

QUESTIONNAIRE FOR INTERNET SERVICE USERS

Dear Respondent,

Please take time to answer the following questions. Additional sheets may be used if necessary. You may also attach any relevant documentation.

All information provided shall be treated with utmost confidentiality, and used only for the intended purpose.

Thank you in advance.

SECTION A: PERSONAL INFORMATION

Full Names [optional]:

Position/ user status (Please tick where appropriate)

Network administrator.

Network user (other).

SECTION B: INTERNET INFRASTRUCTURE

(a.) How do you access Internet services? Please tick where applicable.

My computer has Internet connection.

I use a computer at my work place.

I use a computer in a cyber café.

Other, please specify

.....

(b.) What type of connection do you have? Please tick where applicable.

Dedicated/Leased line.

Dial-up connection.

(c.) Do you connect directly to your ISP, or do you go through a point-of-presence (PoP)?

.....
.....

(d.) What is the connection speed (bandwidth), of your connection, as per the service level agreement? Please tick where applicable.

- 56kbps
- 64kbps
- 128kbps
- 256kbps
- Other, please specify

.....

(e.) What is the minimum and maximum link/connection speed experienced in your connection?

- Minimum Kbps
- Maximum Kbps

SECTION C: INTERNET SERVICES

(a.) What Internet service do you use? Please tick as applicable.

- Web browsing
- Electronic mail
- File transfer (downloads and uploads)
- Voice over IP
- Video conferencing
- Other, Please specify

.....

(b.) How are the Internet services charged? Please tick where applicable.

- By time duration.
- Flat rate, plus time.
- By bandwidth.
- Other, please specify

.....

(c.) Please rate the frequency of use, for each of the Internet service, in the matrix below:

| | <u>Very often</u> | <u>Often</u> | <u>Occasionally</u> | <u>Rarely</u> | <u>Never</u> |
|--------------------|--------------------------|--------------------------|--------------------------|--------------------------|--------------------------|
| Web browsing | <input type="checkbox"/> | <input type="checkbox"/> | <input type="checkbox"/> | <input type="checkbox"/> | <input type="checkbox"/> |
| Electronic mail | <input type="checkbox"/> | <input type="checkbox"/> | <input type="checkbox"/> | <input type="checkbox"/> | <input type="checkbox"/> |
| File transfer | <input type="checkbox"/> | <input type="checkbox"/> | <input type="checkbox"/> | <input type="checkbox"/> | <input type="checkbox"/> |
| Voice over IP | <input type="checkbox"/> | <input type="checkbox"/> | <input type="checkbox"/> | <input type="checkbox"/> | <input type="checkbox"/> |
| Video Conferencing | <input type="checkbox"/> | <input type="checkbox"/> | <input type="checkbox"/> | <input type="checkbox"/> | <input type="checkbox"/> |
| Other, | <input type="checkbox"/> | <input type="checkbox"/> | <input type="checkbox"/> | <input type="checkbox"/> | <input type="checkbox"/> |

(d.) What is your preferred mode of costing for Internet services? Please tick as appropriate.

- By time, depending on bandwidth.
- By the bytes sent/ received.
- By time, regardless of bandwidth.
- A single flat rate per month.
- Other, please specify

.....

SECTION D: QUALITY OF SERVICE

(a.) Do you know about Internet Quality of Service (QoS)?

- Yes
- No
- Not sure

(b.) Does your ISP offer ANY guarantees on the level of service provided?

Yes No I don't know

If Yes, please briefly explain:

.....

(c.) Does your service provider offer support for the existing QoS models?

Diffserv Yes No Not sure

Intserv Yes No Not sure

MPLS Yes No Not sure

(d.) Would you consider the Internet services you receive as quality?

Yes No

Please explain:

.....

(e.) Which of the following factors would you consider important, in determining acceptable service levels. Please rate each of the factors in the matrix below.

| | <u>Very Important</u> | <u>Important</u> | <u>Necessary</u> | <u>Optional</u> | <u>Not Important</u> |
|-------------------------|--------------------------|--------------------------|--------------------------|--------------------------|--------------------------|
| Cost | <input type="checkbox"/> | <input type="checkbox"/> | <input type="checkbox"/> | <input type="checkbox"/> | <input type="checkbox"/> |
| Link availability | <input type="checkbox"/> | <input type="checkbox"/> | <input type="checkbox"/> | <input type="checkbox"/> | <input type="checkbox"/> |
| Link capacity/Bandwidth | <input type="checkbox"/> | <input type="checkbox"/> | <input type="checkbox"/> | <input type="checkbox"/> | <input type="checkbox"/> |
| Packet loss rate | <input type="checkbox"/> | <input type="checkbox"/> | <input type="checkbox"/> | <input type="checkbox"/> | <input type="checkbox"/> |
| Average link speed | <input type="checkbox"/> | <input type="checkbox"/> | <input type="checkbox"/> | <input type="checkbox"/> | <input type="checkbox"/> |
| Delay variation/ jitter | <input type="checkbox"/> | <input type="checkbox"/> | <input type="checkbox"/> | <input type="checkbox"/> | <input type="checkbox"/> |

(f.) Would you be willing to pay more to obtain better and quality service?

Yes No

(g.) Which of the following statements describes your desired service type? Please tick where applicable.

[] I would prefer a fast link, with guaranteed minimum bandwidth.

[] I wouldn't mind a low speed link, provided I only pay for the bytes sent/received.

[] I would prefer a connection with guaranteed availability, regardless of speed.

[] Other, please specify:

.....
.....

SECTION E: ADDITIONAL COMMENTS

Please provide ANY necessary additional comments, on the Internet Quality of Service, in the space below:

.....
.....
.....

APPENDIX D: QUESTIONNAIRE 2

1. Target Respondent

This questionnaire is meant for Internet service providers.

2. Objectives

- a. To determine the applications/services making up Internet services in Kenya.
- b. To determine the service differentiation approaches used by ISPs.
- c. To determine the costing models used by ISPs in Kenya.
- d. To determine the minimal infrastructure requirements (if any) for each type of service provided.
- e. To determine the extent to which service providers in Kenya support provision of quality enabled services.
- f. To determine the quality of service model (if any) used by each service provider.
- g. To determine the Quality of Service parameters taken into account by ISPs.
- h. To determine the measures put in place by ISPs to ensure that services, as defined in the SLA, are actually delivered.
- i. To determine the level at which ISPs are satisfied with the service delivered.

3. Questionnaire structure

This questionnaire is divided into nine (9) sections. Each of the section tries to address a critical area of the required information.

- a. Organizational details.
- b. Internet services.
- c. Infrastructure.
- d. Quality of service.
- e. File transfer.
- f. E-mail and web access.
- g. Voce over IP and Audio on demand.
- h. Video conferencing and video on demand.
- i. Further comments.

4. Mode of delivery/ presentations

For the purposes of presenting the questionnaire to the respondent, and receiving the response, the following approach shall be adopted:

- a. A random sample of ten (10) service providers, within Nairobi, will be selected.
- b. A test run will be conducted with one of the non-selected ISPs.
- c. Collections and alterations may be made based on the results of the test run.
- d. A copy of the questionnaire shall be delivered, manually, to each of the chosen respondents.
- e. The completed questionnaires shall be collected, after seven days, for analysis.
- f. Where clarification is necessary, an Interview shall be organized with one or more of the respondents.

QUESTIONNAIRE FOR INTERNET SERVICE PROVIDERS

Dear Respondent,

Please take time to answer the following questions. Additional sheets may be used if necessary. You may also attach any relevant documentation.

All information provided shall be treated with utmost confidentiality, and used only for the intended purpose.

Thank you in advance.

SECTION A: ORGANIZATION DETAILS

Name of Organization [optional]:

Name of officer:

Position held in organization:

SECTION B: INTERNET SERVICES

1. Briefly outline the different Internet services offered by your organization. [Please attach a copy of the Service Level Agreement (SLA), if possible]

.....
.....
.....
.....
.....
.....
.....

2. What service differentiation approach do you use? Please tick [✓] where applicable.

[] Dial-up connection vs dedicated (leased) line.

[] High bandwidth service vs low bandwidth service.

[] Guaranteed service vs best-effort service.

[] Other, please specify:

.....

3. How do you charge out the services offered? Please tick (√) where applicable.

[] By the number of hours of connection

[] By the number of bits delivered / received

[] Fixed monthly rate

[] Bandwidth dependent variable monthly rates

[] Fixed rate plus cost for duration of connection.

[] Fixed rate plus cost for bandwidth usage.

[] Fixed rate plus cost per bit / byte.

[] Other, please specify:

.....

4. Do you offer service level guarantees for your clients? Please tick (√) where applicable.

[] Yes [] No

If **Yes**, briefly explain

.....

.....

.....

.....

5. What factors do you consider in the provision of Internet services? Please tick (√) where applicable.

[] Available bandwidth

[] Link availability

Network reliability

Network security

other, please specify:

.....

6. Does your service contract (SLA) specify the applications/services to be supported?

Please tick (√) where applicable.

Yes No

If yes, answer part 7. If NO, answer part 8

7. If yes, how do you handle additional services? Please tick (√) where applicable.

Customer is free to run additional service/application.

Customer must first request the additional service.

A new agreement is needed for additional applications.

Other, please specify:

.....

8. If no, how do you determine the applications to be supported? Please tick (√) where applicable.

Customer can run any applications.

Only web and E-mail applications are supported.

Additional agreement is required for some applications.

Other, please specify

SECTION C: NETWORK INFRASTRUCTURE

1. Do you offer services directly to end-users, or do you use intermediate points (point-of-presence)? Please tick (√) where applicable.

Direct link

Through Point-of-presence

Both approaches

2. If both, which do you consider more preferable? Please explain:

.....
.....
.....

3. What is the minimum link capacity that you currently support?

For direct link to client

For link through point-of-presence

4. What is the maximum link capacity that you currently support?

For direct link to client

For link through point-of-presence

5. Do you have any specific agreements with infrastructure providers to ensure minimum service levels are maintained?

Yes No

If Yes, please explain:

.....
.....
.....

6. How does offering services through an intermediate point affect the type and level of service you can provide?

.....
.....

.....
.....

SECTION D: OUALITY OF SERVICE:

1. Do you have in place a quality of service (QoS) policy for the services offered to your clients? Please tick (√) where applicable.

[] Yes [] No

If yes, please explain [You may attach a policy document where applicable]

.....
.....
.....

2. What service model (s) do you currently support? Please tick (√) where applicable.

[] Differentiated services (Diffserv)

[] Integrated services (Intserv), with RSVP

[] Multiprotocol Label Switching (MPLS)

[] Other, please specify

3. What factors do you consider in the implementation of the QoS? Please tick (√) where applicable.

[] Bandwidth

[] Packet delay

[] Packet loss

[] Delay variation (jitter)

[] Other, please specify

4. What, in your opinion, are the limitations to quality Internet services in Kenya?

.....
.....
.....

5. Please provide your opinion on the Internet services in Kenya, by answering the questions below:

a. Do the internet services meet the minimum quality requirements?

Yes No

b. Does the Internet infrastructure in Kenya support QoS implementation? Please explain.

Yes No

SECTION E: FILE TRANSFER:

1. Do you support bulk file transfers for your clients? Please tick (✓) where applicable.

Yes No

If **yes**, answer the remaining parts in this section.

2. Do you have measures in place to avoid/minimize packet loss during file transfer?

Yes No

If Yes, please explain

.....
.....
.....

3. How much bandwidth have you allocated to support file transfer? Please tick (✓) where applicable.

None up to 64 kb up to 128 kb other, specify _____

4. What is the minimum and maximum file size supported?

Minimum _____

Maximum _____

5. Do your clients have any specific requirements with regard to file transfers?

Yes No

If yes, please explain

.....
.....
.....

SECTION F: E-MAIL AND WEB ACCESS:

1. How do you support reliability for E-mail and web access? Please tick (√) where applicable.

using buffers

by resource allocation

other, please specify

2. Briefly describe measures in place (if any) to reduce delay for web access:

.....
.....

SECTION G: VOICE OVER IP AND VOICE ON DEMAND:

1. Do you offer Voice over IP and Audio on demand services? Please tick (√) where applicable.

Yes No

If yes, proceed to the remaining parts of this section.

2. Do you have any specific requirements for customers wishing to use the service?

Yes No

If yes, please explain

.....
.....
.....

3. Do you offer any service-level guarantees for VoIP applications?

Yes No

If yes, what aspect does the guarantee address? Please tick (√) where applicable.

- Bandwidth
- Average link availability
- Packet delay
- Delay variation (jitter)
- Reliability (packet loss)
- Other, please specify

4. To what category of clients do you offer VoIP? Please tick (√) where applicable.

- Dedicated/ leased line clients only
- Both leased line and dial-up clients
- Other, please specify

5. What approach do you use for quality of service implementation on VoIP? Please tick (√) where applicable.

- Differentiated services (Diffserv), with DSCP.
- Integrated services (Intserv), with RSVP
- Multiprotocol Label Switching (MPLS)
- Other, please specify

SECTION H: VIDEO CONFERENCING AND VIDEO ON DEMAND:

1. Do you offer Video Conferencing and Video on demand services? Please tick (√) where applicable.

[] Yes [] No

If yes, proceed to the remaining parts of this section.

2. Do you have any specific requirements for customers wishing to use the service?

[] Yes [] No

If yes, please explain

.....
.....
.....

3. To what category of clients do you offer Video Conferencing? Please tick (√) where applicable.

[] Dedicated/ leased line clients only

[] Both leased line and dial-up clients

[] Other, please specify

4. Do you offer any service-level guarantees for Video Conferencing applications?

[] Yes [] No

If yes, what aspect does the guarantee address? Please tick (√) where applicable.

[] Bandwidth

[] Average link availability

[] Packet delay

[] Delay variation (jitter)

[] Reliability (packet loss)

[] Other, please specify

5. What approach do you use for quality of service implementation on Video Conferencing? Please tick (√) where applicable.

- Differentiated services (Diffserv), with DSCP.
- Integrated services (Intserv), with RSVP
- Multiprotocol Label Switching (MPLS)
- Other, please specify

SECTION I: OTHER SERVICES:

(Please complete a copy of this section for each additional service)

1. Name of service/ application

2. Do you have any specific requirements for customers wishing to use this service?

- Yes No

If yes, please explain

.....

.....

.....

3. To what category of clients do you offer the service? Please tick (√) where applicable.

- Dedicated/ leased line clients only
- Both leased line and dial-up clients
- Other, please specify

4. Do you offer any service-level guarantees for applications using this service?

- Yes No

If yes, what aspect does the guarantee address? Please tick (√) where applicable.

- Bandwidth
- Average link availability

- Packet delay
- Delay variation (jitter)
- Reliability (packet loss)
- Other, please specify

5. What approach do you use for quality of service implementation? Please tick (✓) where applicable.

- Differentiated services (Diffserv), with DSCP.
- Integrated services (Intserv), with RSVP
- Multiprotocol Label Switching (MPLS)
- Other, please specify

SECTION J: FURTHER COMMENTS:

Please provide your comment on the Internet Quality of Service in Kenya.

.....

.....