

**A MORPHOSYNTACTIC ANALYSIS OF AGREEMENT IN  
EKEGUSII IN THE MINIMALIST PROGRAM**

**BY**

**BASWETI, NOBERT OMBATI**

**A DISSERTATION SUBMITTED IN PARTIAL  
FULFILMENT OF THE REQUIREMENTS OF MASTER OF  
ARTS IN THE UNIVERSITY OF NAIROBI.**

**UNIVERSITY OF NAIROBI  
EAST AFRICANA COLLECTION**

**DEPARTMENT OF LINGUISTICS AND LANGUAGES**

**2005**

University of NAIROBI Library



0442158 2

UNIVERSITY OF NAIROBI

DECLARATION BY CANDIDATE:

This is a thesis of my original work and has not been presented for a degree in any other university.

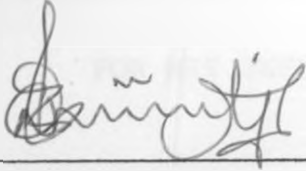

1. 11. 2005

BASWETI NOBERT OMBATI

DATE

DECLARATION BY SUPERVISORS:

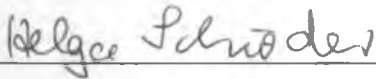

1. 11. 2005

DR. HELGA SCHRODER  
DOCTOR OF LINGUISTICS  
UNIVERSITY OF NAIROBI

DATE

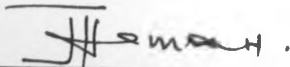

9. 11. 05

DR. HABWE JOHN  
DOCTOR OF LINGUISTICS  
UNIVERSITY OF NAIROBI

DATE

DEDICATION:

TO MY ALMIGHTY GOD;

FOR HIS INSUMMOUNTABLE LOVE.

MY EVER LOVING FATHER, JOHNSON BASWETI,

MY BELOVED MOTHER, ELIZABETH MOIGE,

MY BROTHERS: DAVID, MAGATI AND AQUINAS,

MY SISTERS: JANET, VANE, JUDY AND SABINA,

MY LOVE, NAOMY;

FOR THEIR PRAYERS, MORAL SUPPORT AND PATIENCE;

ALL OF WHOM I ATTRIBUTE THIS ACADEMIC ACHIEVEMENT

~~TO~~.

AND MY LATE GRANDFATHERS, ABRAHAM AND AMING'A

AND MY FOREGONE GRANDMOTHER, SARAH NYABATE;

THEIRS IS AN EVERLASTING 'OMWANDO'.

## ACKNOWLEDGEMENTS

My sincere appreciation goes to my supervisors, Dr. Helga Shroder and Dr. John Habwe for taking me through the research process right from the proposal presentation and defence, analysis of the data up to the end of this research project. Their constructive criticism throughout the rigorous analysis stage made this work to be what it is. The material and academic pieces of advice I received from Prof. Nyombe all through the study and more especially his initial supervision, is a vital acknowledgement.

I also wish to thank Prof. Okoth Okombo, Prof. Abdullaziz and Prof. Lucia Omondi in the critical eye that they gave this work in addition to their constant encouragement. Prof. Kithaka Wa Mberia and Dr. Mbatia, as outgoing and current chair of the department, are also worth a mention for their successful administrative coordination of the postgraduate programme. The inspiration I derived from Dr. Kaviti especially in controversial issues in the project doubled my morale to carry on the study to its ultimate end.

I cannot forget to recognise other members of staff who have been my mentors like Dr. Buregeya, Dr. Eshun, Dr. Marete, Mr. Manyora, Mr. Mungania, Mr Ragutu and Mrs. Kiranga among others for the great work they did during coursework as my lecturers. Their

inspiration and encouragement has always implanted in me an unequivocal optimism.

I particularly thank Mr. Muli Musyoki of Longhorn Publishers from whose invaluable assistance, through Nduku, I was able to get the finances to do the research, analyse and package this work. My classmates: Malanda, Martha, Indimuli, Judy, Kivuko, Ngure, Asumta, Lucyline, Rehab, Macharia, Marianne, Purity, Wanja, Frida, Ochieng, Gichamba, Mediatrix, Rukia, Mary, Nyabunga, Vero, Karren, Jerusha, Lily and many others deserve a pat for being there for me. Mwange Kiganda, Steve Nyamwange, Kim, Rodney, Sam Ongwae, Shaggy, Sibota, Okumu, Leah, Rose, Caren, John, Nyatika, Nyabirenge, Eve, Fred, Daktari, Orina, Gatobu, Jayne, Pauline and Lucille, just to mention a few, saw me through the project.

Among the many people who assisted me typeset and / or print this work I recognise the spirited girl, Shiro, for her determination and punctuality in her computer expertise, which saw this project completed in good time.

I would like to thank my family (including Uncle George and Joel) and friends who in one way or another gave me a hand during the study.

Finally, I feel much indebted to the many linguists whose works are referred to in this dissertation. The success of this project derives a lot from their earlier related studies or works in syntax generally.

## ABSTRACT

The chief focus of this study was to analyse Agreement in Ekegusii. It relates agreement in between the elements in a sentence to the concord in the Ekegusii determiner phrase. Full interpretation and feature checking in the Minimalist Program (Chomsky 1993, 1995) motivate movement of elements both in the Ekegusii sentence and determiner phrase.

Chapter one introduces the background to the study, various aspects of the Minimalist Program, which is the theoretical framework among other things.

Chapter two examines the nominal structure of Ekegusii, highlighting the noun class system and concord between the noun and its modifiers.

Chapter three draws a parallel between the agreement system in the Ekegusii DP and sentence.

Chapter four particularly analyses the Ekegusii determiner phrase. The morphosyntactic aspects of the Ekegusii DP internal concord are handled, showing the various modifying elements of the noun in the language.

Chapter five concludes up the study that indeed the MP is adequate enough to analyse such a morphosyntactic aspect as agreement in the Ekegusii DP and sentence. The principles at work in the MP: feature checking and Full Interpretation are reliable in studying Ekegusii morphosyntax.



# CONTENTS

PAGE

DECLARATION .....	i
DEDICATION .....	ii
ACKNOWLEDGEMENT .....	iii
ABSTRACT .....	vi
CONTENTS .....	viii
LIST OF TABLES .....	xi
ABBREVIATIONS .....	xii
CHAPTER ONE: BACKGROUND TO THE RESEARCH .....	1
1.1 Introduction to the Language of Study .....	1
1.2 Statement of the Problem .....	2
1.3 Hypothesis .....	3
1.4 Objectives .....	4
1.5 Scope and Limitation .....	4
1.6 Rationale of the Study .....	5
1.7 Theoretical Framework .....	6
1.7.1 The Minimalist Program .....	6
1.7.2 Philosophical Background .....	6
1.7.3 Computation from the Lexicon to the Interface .....	9
1.7.4 The place of Morphology in the M.P .....	14
1.8.0 Literature Review .....	16
1.8.1 Ekegusii and other Bantu Language Studies .....	16
1.8.2 Theoretical Literature .....	19

1.8.3 Agreement/concord Literature .....	23
1.9.0 Methodology .....	24
CHAPTER TWO: EKEGUSII NOMINAL STRUCTURE .....	25
2.0 Introduction .....	25
2.1 The Morphological structure of the Nominal .....	25
2.2 The Ekegusii Noun Classification System .....	27
2.3 Structural Description of the Noun Classes .....	29
2.3.1 Class 1 / 2 Nouns .....	29
2.3.2 Class 3 / 4 Nouns .....	31
2.3.3 Class 5 / 6 Nouns .....	33
2.4 The Noun and its Modifying Elements .....	35
2.4.1 The Noun Agreement with Demonstratives .....	35
2.4.2 Noun Agreement with Possessives .....	38
2.4.2.1 Possessives pronouns .....	38
2.4.2.2 Possession in the Genitive NP .....	40
2.4.3 Noun Agreement with Quantifiers and Numerals .....	41
2.4.4 Noun Adjective Agreement .....	45
2.4.4.1 Complex Adjectives .....	46
2.5 Summary .....	47
CHAPTER THREE: THE DP AND ITS SENTENTIAL SYMMETRY .....	48
3.0 Introduction .....	48
3.1 Agreement in the Ekegusii sentence .....	49

3.1.1 The Subject Agreement phrase (AGRsP) in Ekegusii .....	50
3.1.2 The Agreement Object Phrase (AGRoP) in Ekegusii .....	52
3.2 Movement and Checking in The Ekegusii Sentence.....	53
3.3 The Ekegusii DP schema .....	58
3.4 Schematic Relationship between the Ekegusii DP and sentence... .....	60
3.5 Summary .....	62
CHAPTER FOUR: DETERMINER PHRASE ANALYSIS .....	64
4.0 Introduction .....	64
4.1 The DP Hypothesis as Motivation for DP Analysis .....	65
4.2 The Determiner Phrase .....	68
4.3 Agreement of Elements in the Ekegusii DP .....	73
4.3.1 Possessives .....	73
4.3.2 Agreement of Demonstratives and Possessives .....	74
4.4 Quantifiers .....	76
4.5 Adjectives .....	81
4.6 Summary .....	84
CHAPTER FIVE: CONCLUSION .....	85
RECOMMENDATIONS .....	86
REFERENCES .....	88

LIST OF TABLES  
(IN CHAPTER TWO)

Table 1: Ekegusii Noun Clauses .....	28
Table 2: Ekegusii Demonstratives .....	36
Table 3: The Concordial Prefix Attached to Ekegusii Demonstrative .....	37
Table 4: Ekegusii Possessive Pronouns .....	39
Table 5: Possessive Prepositions with Genitive NPS .....	41
Table 6: Agreement Prefixes in Quantifiers .....	44

## ABBREVIATIONS

ADJ/Adj	Adjective
AGR/Agr	Agreement
AGRCM	Agreement class marker
AGRO/AGRO <sup>1</sup> /AGRO <sub>P</sub>	Agreement Object (phrase)
AGRS/AGRS <sup>1</sup> /AGRS <sub>P</sub>	Agreement Subject (Phrase)
ASP	Aspect
Cl	Class
C/C <sup>1</sup> /CP	Complement
D(et)	Determiner
DEM	Demonstrate
D-S	Deep structure
DP	Determiner Phrase
DV	Derivative
FI	Full Interpretation
F.v	Final Vowel
GB	Government and Binding
INFL	Inflection
IP	Inflection Phrase
LF	Logical Form
MP	Minimalist Program
N	Noun
NP	Noun Phrase
NUM	Numeral

NUM/NUM <sup>1</sup> /NUMP	Number (Phrase)
O.A	Object Agreement
O.A.M	Object Agreement Marker
PF	Phonological Form
Pl	Plural
Prep	Preposition
POS	Possessive
Pr/pref	Prefix
Q/Q <sup>1</sup> /QP	Quantifier Phrase
Quant	Quantifier
Rt/rt	Root
SS	Surface Structure
S.A	Subject Agreement
S.A.M	Subject Agreement Worker
Sins	Singular
SPEC/spec	Specifier
t	Trace
to	Trace/Object
tv	Trace/Verb
Ts	Trace/Subject
TNS/TNS <sup>1</sup>	Tense
UG	Universal Grammar
V/V <sup>1</sup> /VP	Verb Phrase
X/X <sup>1</sup> /XP	Any Phrase
IPS	First person singular

2PS Second Person Singular

3PS Third Person Singular

# CHAPTER ONE: BACKGROUND TO THE RESEARCH

## 1.1 INTRODUCTION TO THE LANGUAGE OF STUDY

The language of analysis in this study is Ekegusii, a Bantu language spoken in the South Western section of the Kenya Highlands in Nyanza Province. Ekegusii is spoken by the Abagusii people who occupy three districts: Kisii Central (Kisii), Kisii South (Gucha) and Kisii North (Nyamira). These speakers, commonly known as the 'Gusii' people are bordered by fellow Bantu speakers and Nilotic speaking communities: the Abakuria (Bantu) towards the south together with the Luo (Nilotic) and the Maasai and Kipsigis (Nilotic), to the East and South East respectively.

According to the Guthrie [1948] classification of Bantu languages, Gusii is grouped along with Kuria and Logoli in group 40 of zone E<sup>1</sup>. Guthrie's classification is based on a methodology whose criteria is grounded on oral traditions of Ekegusii speakers thus rendering him then to group languages whose speakers have a close affinity in such traditions.

There is little or no dialectal variation in Ekegusii. Majority of the speakers of the language speak a uniform variety but for some slight variation in terms of vocabulary and

---

<sup>1</sup> This zone was mainly composed of languages from the Bantu family that were spoken by speech communities that were very related.



pronunciation amongst Ekegusii speakers in South Mogirango Location. This study analyses data based on the assumption that the language has one uniform variety.

## 1.2 STATEMENT OF THE PROBLEM

Among some of the recent syntactic developments, the noun phrase has been reanalysed as a determiner phrase (DP) (Nyombe (2004), Abney (1987) among others). This study analyses the Ekegusii determiner phrase (DP) with an inquiry into the relationship between agreement of the INFL (sentence) and concord in the noun phrase (henceforth, determiner phrase). The following data exemplifies the existence of the agreement in the Ekegusii language:

1. Na - mo - rager -I - a  
 Ips1AGR 3ps1AGR feed pst/caus f.v  
 'He fed him.'
  
2. E-ngombe ya tata  
 9AGR cow 9AGR father  
 'My father's cow'
  
- 3 a) e - buku e - ri - a  
 Sing9AGR Bible sing9.AGR that f.v  
 'That Bible'
  
- b) Chi - buku chi - ri - a  
 plu10.AGR Bible plu10.AGR those f.v  
 'Those Bibles'

In the examples above, there is concord in examples (2) and (3) between the noun and its modifiers. {e-} is the concordial prefix in the two examples. In example (1), the sentence given from the language exhibits agreement in class and number between the subject and object markers and the verb. The example exhibits agreement marking from class 1 and both the subject and object are singular (number). In employing the Minimalist Program (MP), the study shall first seek to establish the domain of the NP in the Ekegusii DP and go ahead to do an investigation into the adequacy of the Minimalist Program in analysing the Ekegusii DP. This study is also geared towards establishing the order of determiners in the DP between the D-head and the NP complement.

### 1.3 HYPOTHESES

This study puts to test the following hypotheses:

- ❖ The Ekegusii sentential Agreement has a symmetrical relationship with the Ekegusii Determiner Phrase internal concord.
- ❖ The feature checking theory and full interpretation (FI) in the Minimalist Program is adequate in the analysis of the internal structure of the Ekegusii DP.

#### 1.4 OBJECTIVES

This study shall be guided by a number of objectives, namely:

- i. To study concord in the Ekegusii DP in order to determine its syntactic function.
- ii. To find out the relationship between the agreement pattern in the sentence (INFL) and the concord of the Ekegusii DP.
- iii. To determine the internal structure of the Ekegusii DP (showing the order of the elements or 'determiners')
- iv. To distinguish the Ekegusii DP from the Ekegusii NP.

#### 1.5 SCOPE AND LIMITATION

This study investigates the morpho-syntactic aspects of the Ekegusii Determiner Phrase. Being an agglutinating language, the morpho-syntactic approach is ideal in the analysis of Ekegusii especially in the Minimalist Program that best accounts for the morpho-syntax of Bantu languages. The study analyses the noun and its modifiers that is demonstratives, possessives, quantifiers and adjectives and their agreement. In relating the DP internal concord with agreement in the sentence, the study cannot avoid exploring through some aspects of the Ekegusii VP.

## 1.6 RATIONALE OF THE STUDY

In the current Minimalist Program, Chomsky (1993, 1995), nothing has been done as far as the employment of the theory in analysing Ekegusii is concerned. Morphological, phonological and some element of syntactic / morpho-syntactic studies using some of the earlier generative theories in analysing Ekegusii have been done. To the best of the knowledge of this research, nothing has been done on the Ekegusii DP under MP. The study thus hopes to fill the existing gap.

Through this study, the structure of Ekegusii just like in the other languages from the Bantu family will be made available hence easier to understand. Such contribution adds credit to the already existing knowledge and literature on the language. The study, similarly, brings an African language into test in the latest theoretical syntactic debate in linguistics. It thus epitomises Chomsky's view of "*the end of syntax*" (Marantz 1995: 380-1) that foresees the "*completion rather than the disappearance of syntax.*"

## 1.7 THEORETICAL FRAMEWORK

### 1.7.1 THE MINIMALIST PROGRAM

The Minimalist Program is a fairly recent development from the Principles and Parameters Theory advanced by Chomsky (1981). The MP has its publication undertones in Chomsky (1989) but its full installation is in Chomsky (1993 and later in 1995) where the linguistics theorist presents a minimalist inquiry into linguistic theory. It is an advent from the Government and Binding grammatical levels of representation: D- structure, S-structure, Logical Form (LF) and Phonological / Phonetic Form (PF), to interface levels, that is just PF and LF. In this reductionist move, Chomsky has tried to minimise syntactic entities and principles for a plausible linguistic expression and explanation (interpretation). The PF interacts with sound / motor articulatory - perceptual faculties whereas the LF interfaces the meaning and conceptual modules of cognition like inference and conceptual - intentional reasoning.

### 1.7.2 PHILOSOPHICAL BACKGROUND

The MP is basically Chomsky's most current Generative Grammar framework. It is thus of some impetus to look at the philosophical background of the Generative grammatical framework developed by Chomsky in the 1950s. Language is seen as being part of the natural world in Generative

Grammar. This language exists as an innate 'language organ' (Newmeyer 1998:305) which is an endowment in the human mind.

In Saussurean terms, the human language faculty is composed of 'langue' and 'parole' components which in Chomskian terms are referred to as 'competence' and 'performance' respectively. Competence (I-language) is the general component responsible for the actual knowledge of the language(s) of a speaker(s) that enables him or her to: make both grammatical and acceptability judgements on constructions in that language; produce well-formed constructions and make an analysis of the syntax of his or her language. Using the knowledge of the grammar of the language, such a speaker is expected to generate an infinite number of correct sentences. In this context, generative grammarians explicate the notion of grammar (Weibelhuth 1995:4). Native speakers of a language have a more superior and specialised competence of their natural language as compared to those to whom the language is a second language (L2). The component of performance (E-language) entails the use of language in the day to day situations and experiences. Among the factors that influence performance is a speaker's linguistic competence. However, a good examination of a speaker's competence ought to be an indirect task of observing a speaker's linguistic

performance. Chomsky (1965: 4) thus epitomises performance as the 'actual use of language in concrete situations'.

Therefore, it is worth noting that Generative Grammar satisfies the three levels of grammatical adequacy for they make up the essence of what Chomsky sought to attain: observational, explanatory and descriptive adequacy. A grammar capable of distinguishing grammatical and ungrammatical constructions in the phonological, semantic, morphological and syntactic senses is said to be observationally adequate. In achieving descriptive adequacy, this grammar comes up with its own set of rules based on the intuition of a native speaker's linguistic competence in determining well-formed or ill-formed structures. An explanation of the existence of the rules of a language or a grammar generally makes up the explanatory adequacy of this model.

Chomsky's pursuit of a universal theory of human language since all human beings have a biological endowment for language (Cowper 1992:5), makes him develop a Universal Grammar (UG) with clear universal bonds and/or constraints within which it operates. The "pre-programmed [nature of human beings] with a basic knowledge of how languages are like and how they work" (Aitchison 1999:28) forms the core of any natural language. Minimalism is thus one of such

informed insights towards developing a theory which is simple enough for easy description of a language.

### 1.7.3 COMPUTATION FROM THE LEXICON TO INTERFACE

In this section, the study looks into the computational system in which derivations conditioned by morpho-syntactic properties of a language occur. By interacting with the lexicon of a particular language, the computational system gives rise into two interface levels of representation: the PF and LF that is after what this study later refers to as 'spell-out'.

From the lexicon, morpho-syntactic and lexical information can be obtained in a process called numeration. The morpho-syntactic and lexical elements are joined to form projections and partial trees through a computational process called merge. What initially used to be referred to as D-structure in GB as a link between the lexicon and the surface structure [syntactic representation] is not provided for in the MP. This is the structure building process of the minimalist program.

The X-bar theoretical assumptions of specifier - head, head - head and head complement relationships are retained in the MP [Chomsky 1993:6]. The diagram below shows the X bar maximum projection:



4.

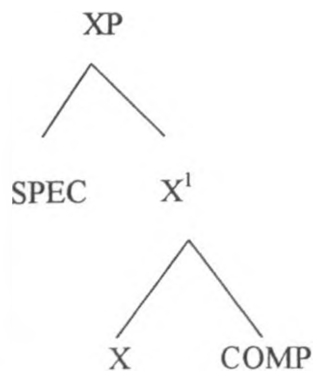

Although the Maximal Projection Principle (Chomsky 1981) projected a wide variety of phrases from the lexicon, the MP structure building process representations are strictly driven by necessity. Structures built must be licensed by morpho-syntactic and lexical evidence from the lexicon of a language. Various positions are thus easily avoided by allowing partial trees with just a head without a complement.

Movement of constituents in GB was spearheaded by the Move X theory which simply implied move anything anywhere although a number of parameters<sup>2</sup> were put in place to contain the movement and limit wild overgeneration (Cowper 1992: 127) whereas such movement was the link between D- structure and the S-structure, movement now in the MP is basically motivated by the feature -checking circumstances. Some positions like SPEC positions are created in the structure building process for the purpose of case checking in the Checking Theory.

---

<sup>2</sup> Some of these parameters include: X Bar Theory – to ensure that move X is structure preserving, Theta theory to ensure NPs only move from and to theta positions; Case filter to ensure that lexical NPS receive case during derivations; Subjacency, to limit the distance of movement and the C- command condition on anaphora of upward movement and C-commanding of traces and their antecedents; move among others.

Focusing on both the INFL and the NP in the checking process, the correctness of inflectional features is checked *vis a vis* their structural positions in the sentence. Marantz, in Webelhuth (1995:363), argues that checking process is meant to eliminate morphological features thus preventing a derivation from crashing / failing to converge<sup>3</sup>.

The theory develops a slightly distinct view on the two functional categories: TNS and AGR. Credit is attributed to Pollock (1989) whose Split -INFL - Hypothesis saw the split of projection of the function heads: TP and AGRP hence AGRs, TNS and AGRo. The two projections: TNS and AGR help in checking the tense and agreement features of the verb. The case and phi- features (agreement features like class and number) off the DP (Originally NP) are also checked off in the process by raising them to SPEC - AGRs and SPEC - AGRo positions. These processes occur during the derivational process between the lexicon and the interface levels. All the abstract features are checked because they are not supposed to surface at the interface representation (Cook & Newson 1996:321).

In the process of derivation, that is the computation of a grammatical representation, a point reaches when the structure is split into two interface levels PF and LF. This point is referred to as 'spell-out' and it determines the kind of

movement that influences the phonological form that is in terms of pronunciation (especially movement occurring before spell-out) and movement to LF, which doesn't necessarily shape the PF.

Ideally, operations between spell out and the two components of interface are computed separately so as to avoid crashing thus encouraging convergence.<sup>4</sup> The diagram below shows the representation of the computational process that sees the production of the two interface levels after the point of spell out:

---

<sup>3</sup> If a derivation converges, the construction will be grammatical but if it is ungrammatical, it will be said to have crashed.

<sup>4</sup> A derivation crashes when phonological and semantic information gets in both of the interface levels: PF & LF making a structure even ungrammatical. Conversely, a derivation converges when the PF and LF conditions are met and the structure is definitely grammatical.

5.

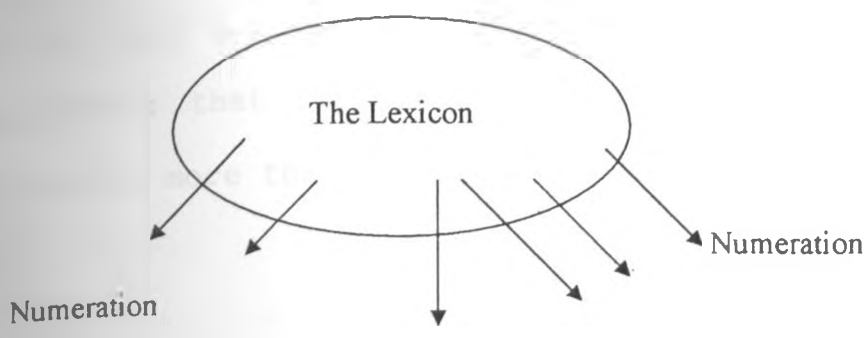

Merge      Merge

↓

Structure-Building: Move & Checking Theory



SPELL - OUT (interface point)



PF Representation  
(Sound/ Motor articulation)

LF Representation  
(conceptual-intentional  
Reasoning/meaning)

Two principles interact in the spell out process: the Full Interpretation and Economy Principles. Whereas Chomsky's Economy Principle is based on the Last Resort principle that champions the shortest move preference, (Chomsky 1993,1995) the Principle of Full Interpretation constrains the appearance of unlicensed lexical or morphological elements. In fact, FI is

more or less a consequence of the Economy of representation requirement: that representation of syntactic structure should not contain more than what is necessary (Cook & Newson 1996:312-13).

#### 1.7.4 THE PLACE OF MORPHOLOGY IN THE M.P.

It is important to note that the MP is dependent on the nature of the morphology of a language. Chomsky puts it clear that the computational process derivations are conditioned by morphological necessity (1993:32). The theory thus gives credence to the morphological component of a language. In accrediting Chomsky, Kaviti (2004: 63) argues that "[for] the lexicon to generate derivationally and inflectionally pre-formed words, it [ought to] contain morphological [grammatical] component."

In the MP, the functioning of the lexicon sharply differs with that of GB. The morpho-syntactic nature of the theory allows for the remittance of inflected nouns and verbs together with their case morphology from the lexicon. The verbs and nouns are not selected in root form to the D structure before moving to the S-structure so as to pick their separately base generated inflectional properties, as is the case in GB. Verb movement is inevitable in the MP because "the morphology associated with the V-root has to be checked by the abstract

features, AGR & TNS" Haegeman (1994:618) Such V-features (AGR and TNS) check verbal properties.

Chomsky (1991a, 1993:7), therefore, presents a new basic sentence structure capturing morphological verb inflections and case marking in the tree below:

6.

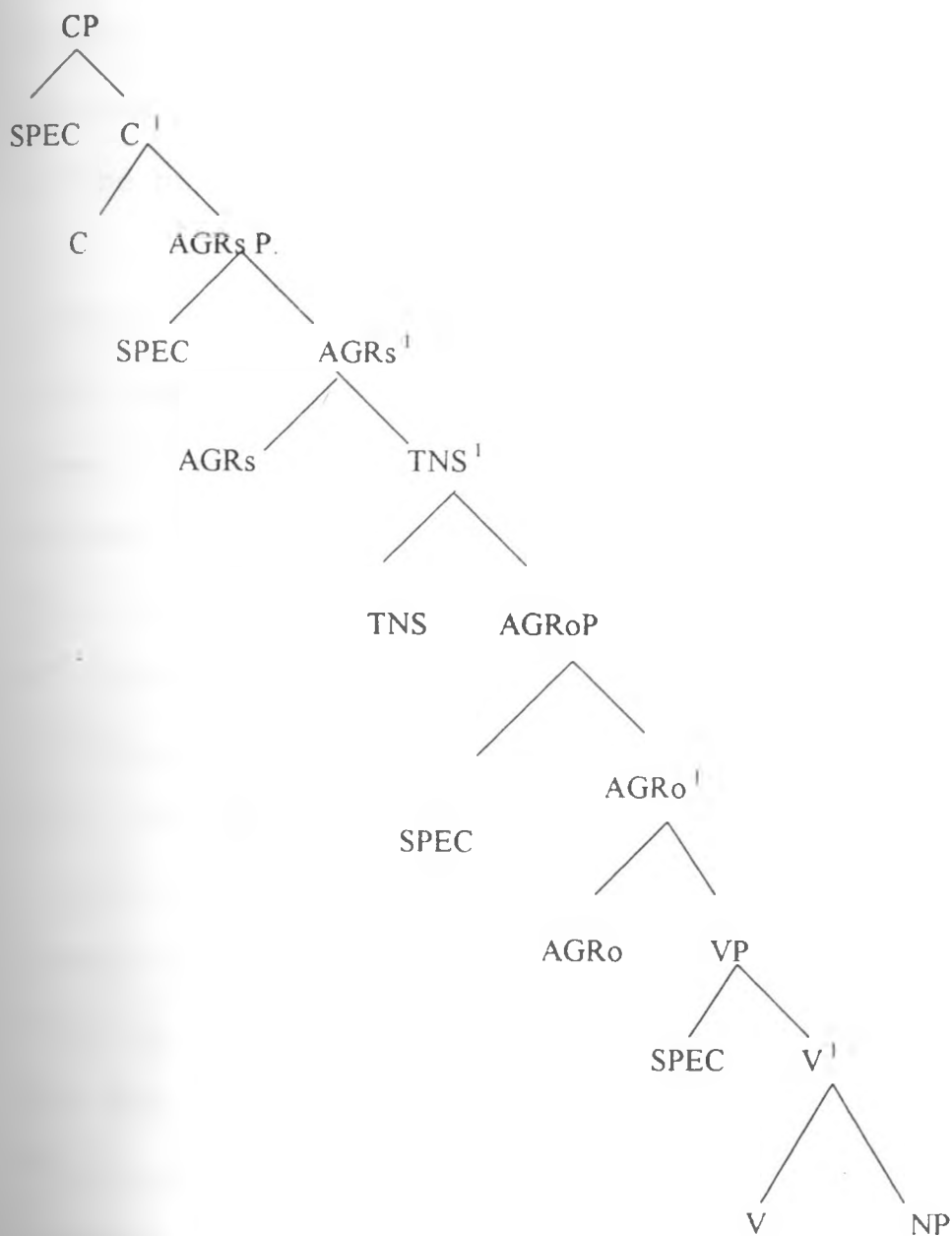

In the above sentence schema, AGRs and AGRO are basically bundles of such features as gender, person and number. The classification distinguishes the two functional roles of AGR; subject and object. A structure like the one above best accommodates the analysis of an agglutinating language like the one in the present study: Ekegusii.

It is worth noting that verbal morphology may go beyond just AGR and TNS to include benefactive, applicative and even causative in some languages but this is extraneous to the present study.

#### 1.8.0 LITERATURE REVIEW:

##### 1.8.1 EKEGUSII AND OTHER BANTU LANGUAGES STUDIES

Some of the works that have been done on Ekegusii were initially simple grammars targeting non-native speakers of the language to have an idea about the operationalisation of the language. These works were mainly studies by missionaries and settlers who had little real knowledge of the language. Among the earliest of such "linguists" is Guthrie (1948) who is mentioned earlier in this study. He classifies Ekegusii in the Kuria and Logoli group (40) in what he calls a Bantu Zone (E) Tucker (1957) concurs with the Guthrie (1948) classification by referring Ekegusii and Kuria languages as the "Gusii Group" out of a more general comparative study of the two languages on their

relatedness. Guthrie (1970a) later on, in a journal, *Collected Papers on Bantu Linguistics*, elaborates on gender, number, person and nominal classes in Bantu languages generally. Such discussion is relevant to this morphosyntactic study.

Whiteley (1960, 1965) has also done such studies: in his 1960 work, Whiteley analyses the morphosyntax of the Gusii tense whereas in the 1965 work, he does a descriptive analysis of the Ekegusii phonological, lexical and morphological and a few aspects of syntax. The formal linguistic analysis that provides a slight feel of the grammar of the language is meant for a "Gusii learner".

Another relevant study that is not purely an Ekegusii language study is the work of Welmers (1973) that is a survey of a variety of structural phenomena that are vital in the analysis of African languages. In as much as this study doesn't isolate a structural analysis of a particular language, its guidelines and analyses are important in the sense that it's easier to determine the various characteristics of the group where Ekegusii falls. Particularly useful studies to this study are a series of M.A. dissertations: Mboga (1989), Mabururu (1994), Osinde (1998), Gesare (1992) and a BA dissertation: Mayaka (2000).



Mayaka (2000) does a syntactic study of Ekegusii simple, complex and compound sentences on the TGG theory. This is helpful to this study for part of it is what goes into the philosophical background of this study's theoretical framework. Information on syntactic organisation of Ekegusii is also made available.

Mabuburu (1994) analyses the degree of relatedness of Ekegusii and Kikuria morpho-syntax with regard to the concordial relationship between the headword in the NP and other sentential elements. From the comparative study, the Ekegusii morpho-syntactic features, which have a direct bearing to the present study, are clearly brought out.

On her part, Gesare, (1992) provides an insight into the Ekegusii morphology through her typological study of the language: a vital ingredient of this study. Mboga (1989) has done a syntactic description of the internal structure of the Ekegusii simple sentence though not in the MP. The work provides morpho-syntactic data from the language, which is vital also.

Another related study is one by Ingonga (1991) who has done a synchronic comparative analysis of three Bantu languages (Ekegusii Lulogooli and Lwitakho) with a focus on

the phonologic, lexical and morpho-syntactic aspects of the languages. Part of this information is useful for the present study.

Njagi (1997) has done a much related study in her analysis of The Kikuyu Determiner Phrase within the Government and Binding Theory on the Principles and Parameters framework. This work is very useful since Kikuyu is in the same Bantu language family and through the present study; the transition from the GB to Minimalism is quite eminent.

The various works singled out on Ekegusii and other Bantu languages provide useful information to this study in presenting morphosyntactic information from the authentic intuition of the native speakers of the language.

Among the identified works on Ekegusii, none of them has done a morphosyntactic analysis of the Ekegusii DP in the Minimalist Program (MP).

### 1.8.2 THEORETICAL LITERATURE

This section traces some of the major syntactic developments on Chomsky's Generative Grammar since its initiation in 1957 and the countdown to the Minimalist Program (1993, 1995). Chomsky's motivation has been an attempt to develop a linguistic theory that could account

for diverse linguistic phenomena in most if not all human languages. This is the pursuit of a universal (theory of) grammar.

In an introduction to Generative Grammatical theory, Chomsky (1957) *Syntactic Structures*, outlines a few ideas on this grammar. The notion of distinguishing phrase structures and their transformations is also advanced further. The 1957 model is further developed in Chomsky (1965) *Aspects of the Theory of syntax*, into what is later called the Standard Theory of Transformational Generative Grammar. This model has two major components: the base component and the transformational component alongside the semantic component. It is in these two components that the Deep Structure (DS) and Surface Structure (SS) are interlinked.

The development of the Standard Theory, its problems that saw the birth of the Extended Standard Theory, which later became the Y model (Revised Extended Standard Theory) and an introduction to GB syntax are outlined in Cowper (1992) *A Concise Introduction to Syntactic Theory: A Government and Binding Approach*.

Chomsky's development of Government and Binding syntax in his (1981) *Lectures on Government and Binding*- has seen many linguists write on the same; Horrocks (1989)

*Generative Grammar*, Borsley (1999) *Syntactic Theory : A Unified Approach*, Heageman (1994) *Introduction to Government and Binding Theory*, Webelhuth (1995) *Government and Binding and the Minimalist Program* among others.

In GB, a set of grammatical principles is controlled by parameters in Chomsky's mission to develop a Universal Grammar (UG). The theory does so in its many sub-theories: Case Theory, Government Theory, Binding Theory, Control Theory, Theta Theory and others. The GB theory maintains the DS and SS but introduces the Phonological / Phonetic Form (PF) and Logical Form (LF).

In an effort to introduce morphology into syntax and integrate the two, Pollock (1989) mentioned earlier, introduces the split-INFL Hypothesis in the article "Verb Movement, Universal Grammar and the structure of the IP", Pollock focuses on French verbal movement; this produces the AGRP and TNSP. For example he proposes that the S - structure of a French sentence:

7. .... *que Marie mange le gateau*

.... *(That Mary eats the cake)*

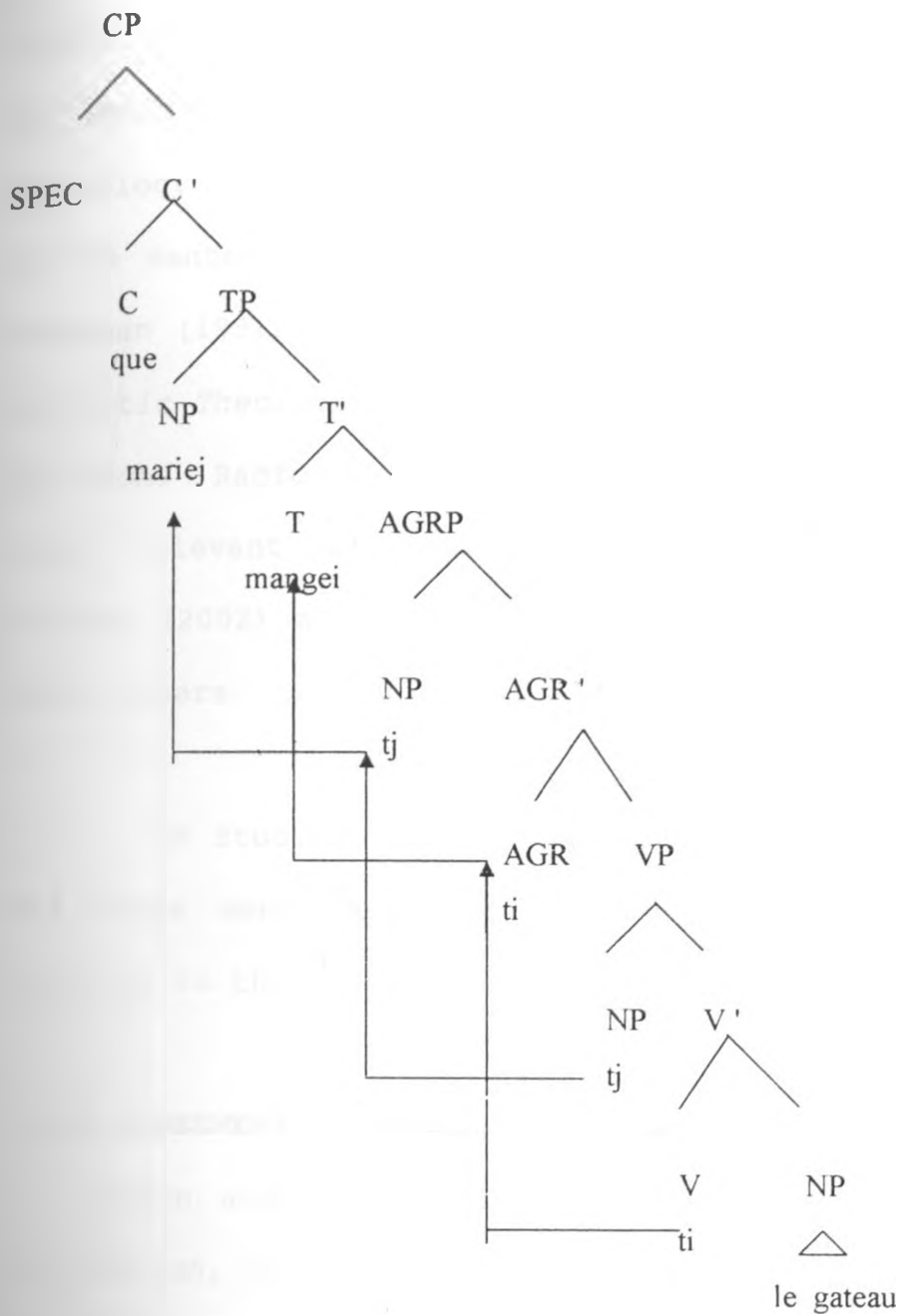

The verb moves from AGR to T; NP moves from VP - SPEC through AGRP-SPEC to TP - SPEC so as to receive nominative case.

Chomsky's MP as outlined in his 1993 article "A Minimalist Program for Linguistic Theory" and Chomsky

(1995) *The Minimalist Program* integrates Pollock's idea of the Split INFL by showing the importance of inflectional morphology and how the verbal morphology is representative of the sentence. The theory is also briefly introduced in Haegeman (1991) *ibid*, Webelhuth (1995) *ibid*. Radford (1997) *Syntactic Theory and the Structure of English: A Minimalist Approach*, Radford (1997) *Linguistics: An Introduction*. Other relevant works on the MP to this study include Shroder (2002) and Kaviti (2004) PhD theses, Ngamau (2004) among others.

DP studies, studies like Nyombe (2004) Abney (1989) and those mentioned earlier like Njagi (1997) are also relevant to this study.

### 1.8.3 AGREEMENT / CONCORD LITERATURE

Leech and Svartik (1994), in *A Communicative Grammar of English*, discuss the concept of agreement which they call 'grammatical concord'. By concord, they mean that all grammatical elements in a phrase (DP as for this study) or a sentence agree with each other. A group of words will be said to agree as Radford (1997: 492) argues, in terms of "some grammatical feature(s) if they have the same value of feature(s)." Therefore concord / agreement can be in terms of such features as class, number, person, tense or gender.

Quirk and Greenbaum (1973) also discuss notion(s) of concord and / or agreement in the book, *A University Grammar of English*. Quite a number of grammar books tackle the issue.

#### 1.9.0 METHODOLOGY

Being a native speaker of the Ekegusii language, much of the data to be analysed in this study is from the intuitive knowledge and competence in the language. However, in concretising the data, there will be quite some consultations with fellow speakers of Ekegusii. Since this study is more theoretical, much of the research will be based on library resources.

## CHAPTER 2: EKEGUSII NOMINAL STRUCTURE

### 2.0 INTRODUCTION

Before embarking on the morphosyntax of the Ekegusii determiner phrase, this chapter addresses the morphology of Ekegusii but through an exploration of the Ekegusii noun class system. Like in majority of Bantu languages, the Ekegusii noun is normally the one that determines the concordial realisation in all the constituents that post-modify it, that is the demonstratives, possessives, quantifiers, and even adjectives. . The study thus considers the relationship between these determiners and the noun in the Ekegusii DP.

### 2.1 THE MORPHOLOGICAL STRUCTURE OF THE NOMINAL

When looking at the morphological structure of the Ekegusii noun, the main focus should be on its morphological constituents. Therefore, in the analysis of the structure of the noun in a Bantu language, Welmers (1973) proposes that it ought to be viewed as constituting a noun prefix and a root. The two constituents that make up the Ekegusii nominal are important because the prefix, for instance, is an indicator of the class. The prefix thus functions as a classifier. Therefore, to the nominal root are attached affixes to form the Ekegusii noun. The Ekegusii nominal is realised as either a simple or derived nominal. Example (8) below illustrates two simple nouns.



	Singular	Plural	Gloss
i)	O - mo - mura	a - ba - mura	
	pr. sing.pr.rt	pr plu.pr. rt	boy(s)
ii)	E -r -ino	a - ma - ino	
	pr. sing.pr rt	pr. plu.pr rt	tooth-teeth

Of the Ekegusii nouns the simple nouns form the largest number as compared to the derived nominals<sup>5</sup>. Example (9) shows two derived nominals.

9.

	Singular	Plural	Gloss
i)	o - mo - rem - i	a - ba - rem - i	
	pr.Sing.pr. dig dv	pr. plu.pr. did fv	diggers(s)
ii)	o - mo - rwan-i	a - ba - rwan - i	
	pr.sing.pr.rt dv.	pr.plu.pr fight fv	fighter(s)

From the above examples, (8 and 9) the Ekegusii noun can be said to have three affixes attached to the nominal root: the pre-prefix, prefix and suffix. The prefix normally co-occurring with the pre-prefix is obligatorily attached to the root. The prefix qualifies a root to become a noun by adding a morphological quality of either number or gender (class).

<sup>5</sup> These are nominals that are formed (derived) from verbs. that is the doer of the action in the verb.

Therefore, the pre- prefix and prefix are class markers which are realised differently in terms of number. Singular nominal forms are represented by such prefixes as {omo-}, {ege -}, {eri -}, {aka -} among others whereas plural forms are represented by such prefixes as {abo -}, {ebi -}, {ama -}, {eme-}. Such prefixes as {obo -} and {oko-} introduce the classes of nouns that retain their forms both in the singular and plural.

## 2.2 THE EKEGUSII NOUN CLASSIFICATION SYSTEM

Being a Bantu language, the noun class system of Ekegusii typically takes a Bantu language noun class typology. The classification system is a morphological system that dictates that the singular and plural prefixes attached to the noun-roots are given different classes.

This noun or nominal phrase has a concord system that normally exists structurally between either a noun and its modifiers or a subject nominal in a sentence with the predicate.

TABLE 1: EKEGUSII NOUN CLASSES

CLASS	NOMINAL PREFIXES AND EXAMPLES					
	SINGULAR	EXAMPLE	GLOSS	PLURAL	EXAMPLE	GLOSS
1 / 2	o-mo-	omonto	person	a - ba-	abanto	people
3 / 4	o-mo -	omote	Tree	e -me -	emete	trees
5/6	(e)-ri -	rioga	flower	a -ma -	amaoga	flowers
7/8	e-ge -	egesusu	rabbit	e -bi -	eBisusu	rabbits
9/10	e -	endo	Lion	ci	cando	lions
11/10	o-ro-	oroBago	Fence	ci-	cimbago	fences
12/8	a - ka -	akamoisi	Boy	e- bi-	eBimois i	boys
14/6	o-Bo-	oBongo oBong'it i	brain selfish n-ess	a-ma -	amaongo	brains
15/6	o-ko -	okogoro	Leg	a- ma	amagoro	legs
16	aa -	aaiga	Place			
17	-me-	nyombaim e	Place			

Meinhof (1932), following Bleek (1971) who had classified proto-Bantu based on semantic criteria, gives the prefix preceding noun roots, different classes (numbers).

Osinde (1988) works out the different noun classes of Ekegusii using the Bleek (1971) criteria and Meinhof's noun classification system. The table above is therefore developed from the Meinhof(1932) ,Bleek(1971) and Osinde(1988) initiatives.

It is important to note that from the Osinde 1988 classification, some of the noun prefixes like classes (14), (15) and (17) have the same prefixes representing both the singular and plural forms of the noun. The represented classes here are those of mass/uncountable or abstract nouns as opposed to the many other classes that stand for countable nouns.

### 2.3 STRUCTURAL DESCRIPTION OF THE NOUN CLASSES.

The Ekegusii noun class system is based on a semantic criterion just like in any other Bantu language in the sense that the categorisation is motivated by what the items(s) / object (s) are in the natural world. In the analysis below, this study note that nouns with the same or similar meanings belong to the same noun class.

#### 2.3.1 CLASS 1/2 NOUNS

These noun classes are normally typically represented by prefixes {o-mo -} / {a-ba -}. {o-mo -} is singular prefix marker and {a-ba - } is a plural prefix marker. The {o-} and {a-} are pre-prefixes which also

keep changing in form in different classes. The two classes commonly consisted of human terms and other kinship or genealogical terms are shown in example (10&11) below:

	<b>Singular</b>	<b>Plural</b>	<b>Gloss</b>
10.	i) o - mo - mura	a - ba - mura	
	pr. sing.pr boy	pr. plu.pr boy	boy(s)
	ii) o -mo -nto	a- ba - nto	
	pr. sing.pr rt	pr. plu.pr . rt	person(s)
11.	i) o - mo - amate	a - ba - amate	
	pr. sing.pr. rt	pr. plu.pr. rt	neighbour(s)
	ii) o - mo- ibori	a- ba - ibori	
	pr. sing.pr. rt	pr. plu.pr. rt	parent(s)

The two prefixes used to be obligatorily occurring together in class 1 / 2 but in some kinship terms, they have been lost such that in class 1 the singular prefix marker {omo-} is now vestigial. This is illustrated in example (12) below.

12.	<b>Singular</b>	<b>Plural</b>	<b>Gloss</b>
	i) Ng'ina	a-ba - ngina	
	Mother	pr. plu.pr mother	mother(s)

ii) Ise                    a - ba - ise  
 Father                    pr. plu.pr. father                    father(s)

Class 1 is indeed a marked class in the noun class system because instead of just being realised with the prefix marker {omo -} that is the pre-prefix {o-} and the singular prefix marker {mo-} this prefix marker has another realisation form that is the variant {mw-} that however retains the pre-prefix {o-} to take the form {omw -}'. This is exemplified in (13) below.

13. Singular	Plural	gloss
i) O - mw - ora	a - ba - ana	
pr. sing.pr rt	pr. plu.pr. rt	child(ren)
ii) O - mw - are	a - ba - are	
pr. sing.pr. rt	pr. plu.pr. rt	initiate(s)

2.3.2 CLASS 3/4 NOUNS

This pair is mainly characteristics of the prefixes {omo -}, {eme-}. {omo-} in the singular prefix marker whereas {eme -} is the plural prefix marker in these classes. This pair is normally representative of names of plants, trees, some parts of the body and objects made from trees. Examples (14) illustrated this.

14.	Singular	Plural	Gloss
i)	O - mo- te	e - me - te	
	pr. sing.pr. rt.	pr. plu.pr. rt	tree(s)
ii)	O-mo - ringamu	e- me- ringamu	
	pr. sing.pr. rt.	pr. plu.pr. rt	gum tree(s)

Class 3/4 nouns may consist of that nouns that do not change in form whether they are used to mean singular or plural (many) / large amounts of something). Some of these are given in example (15) below:

15.	Word	Gloss
i)	O - mo - kenye	'sand'
	pr. sing.pr. rt.	
ii)	O - mo - sunte	
	pr. sing.pr. rt.	'Darkness'

Although the above example (17) forms of nouns can be used to denote large amounts of constituents given, the language can

---

<sup>6</sup> This little explanation is an aspect of phonology which is interlinked to phonology, otherwise called a morphophonological elaboration.

also accept the plural forms of the above words taking the form {eme-} especially when talking about different types of these items. This is illustrated in example (16) below.

16.	Singular	Plural	Gloss
i)	O - mo - kenye	e- me - kenye	
	pr. sing.pr. rt.	pr.plu.pr. rt.	Sand
ii)	O - mo - sunte	e - me - sunte	
	pr. sing. pr. rt.	pr. plu. pr. rt.	Darkness

### 2.3.3 CLASS 5/6 NOUNS

These classes are introduced by prefixes {(e)ri-}/{ama-}. {eri - } or prefixes {ri-} is the singular prefix marker whereas {ama- } is the plural prefix marker. These classes constitute a variety of nouns ranging from body parts, plant parts, fighting objects and many other objects. In example (17) below a few of these are shown.

17.	Singular	Plural	Gloss
i)	E - ri - iso	a - ma - iso	
	pr. sing. pr. rt.	pr. plu.pr. rt.	Eye(s)
ii)	Ri - oga	a - ma - oga	
	sing. pr. rt	pr. plu. pr. rt.	Flower(s)



This class may at times be used to show the courageous of some stem from other noun classes this claiming them to belong to the two classes at the same time. This is illustrated in (18) below.

18.	Singular	Plural	Gloss
i)	Ri - gaka	a - ma- gaka	
	sing.pr. Rt.	Pr. Plu.Pr. Rt	Big old man (oldmen)
ii)	Ri - mori	a - ma - mori	
	sing.Pr. Rt	pr. Plu.Pr. Rt	Big calf (calves)

All the other noun classes can be analysed using the above framework. Thus to avoid too much monotony the study moves to the relation of the Ekegusii noun with its modifying elements.

In conclusion, the 17 classes of Ekegusii nouns are distributed according to the following criteria: occurrence in nature (semantically) and number system (countable or uncountable - morphologically). Since morphological information is important in this study, emphasis has been given on the singularity or plurality of the prefixes and/or the classes. In fact, the classes are spread into two main divisions that is, in every pair there is both a singular set of nouns and a plural set of nouns such that this study notes that most half the classes is in singular and other plural. Therefore, the class

markers basically take the form: singular/plural prefixes although there are cases like in class 17 which take a suffix.

The semantic and morphological information of the Ekegusii nominal in this section is important to the later analysis that is in chapter 3 and 4 where this study analyses the co-occurrence of the nominal with other elements either in the nominal internally or in a sentence. The interest of this study is that of constructing the internal structure of the Ekegusii determiner phrase and the above is only the first step in this study.

## 2.4 THE NOUN AND ITS MODIFYING ELEMENTS

This section investigates the relationship between the noun and its modifiers in the Ekegusii NP (DP). This study shall later revisit these modifiers in Chapter Four where the Ekegusii determiner(s) is determined.

### 2.4.1 THE NOUN AGREEMENT WITH DEMONSTRATIVES

Three sets of demonstrative can be established in Bantu languages (including Ekegusii)- depending on the position of the speaker or hearer. Demonstrations have been classified as either proximal (near to the speaker) or distal (distant from speaker) (Leech and Svartvik 1994:269). The table below shows the occurrence of the Ekegusii demonstrations.

TABLE 2: EKEGUSII DEMONSTRATIVES:

TYPE OF DEMONSTRATIVE		MEANING
<u>1. PROXIMAL</u>		(Near to both the speaker and hearer)
<u>Singular</u> This	<u>Plural</u> These	
<u>2. DISTAL</u>		Far from the speaker and hearer
<u>Singular</u> That	<u>Plural</u> Those	
That'	Those'	

Mabururu (1994) has done a classification similar to the one in the table above. In Ekegusii, the class prefix of the noun in the NP determines the Concordial prefix attached to the demonstratives. Example:

cl.pref. N.rt cl.pref. Dem.rt.

19. a) O-mo- nto o - yo

cl.l.sing person cl.l.agr this

"This person"

b)E - bi- nto                      e - bio

Cl.8.pl things                      cl.8.agr those

"Those things".

The realisation of the Ekegusii demonstratives and their agreement with the words in the different noun classes in the language is coded in the table below.

TABLE 3: THE CONCORDIAL PREFIX ATTACHED TO EKEGUSII DEMONSTRATIVE:

NOUN CLASS	DEMONSTRATIVES					
	This	These	That	Those	That'	Those
O-mo-/aba-	o-yo	a-ba	a-ria	Ba-ria	o-yio	a-buo
Omo - / eme-	o-yo	e-ye	o-ria	e-ria	o-yio	e-yio
(e) - ri- /ama	e-ri	a-ya	Ri-ira	a-ria	e-rio	a-yio
E-re-/e- bi-	e-ke	e-Bi	Ke-ria	Bi-ria	Ekio	e-bio
E - / ci	e-ye	e-ci	e-ria	ci-ria	e-yio	e-cio
-oro-/ci	o-ro	e-ci	Ro-ria	ci-ria	o-ruo	e-cio
A-ka-e-bi-	a-ka	e-Bi	Ka-ria	Bi-ira	a-koo	e-Bie
A-bo-/a-ma	o-Bo	a-ya	Bo-ria	a-ria	a-buo	e-yio
O-ko-/a-ma	o-ko	a-ya	Ko-ria	a-ria	o-ku	a-yio
Aa-	Aa	aa	a-ria	-	Abuo	a-yio
-me	-		-	-	-	

## 2.4.2 NOUN AGREEMENT WITH POSSESSIVES

This section exploits the relationship that exists between the noun and the possessives in the Ekegusii NP. Being one of the post modifiers of the Ekegusii DP, the possessives also perform a determining function as noted earlier in this study. Possession in Ekegusii is indicated either by use of possessive pronouns or by using a preposition.

### 2.4.2.1 POSSESSIVE PRONOUNS

Possessive pronouns are used to indicate ownership of something. The possessive pronoun in Ekegusii, as Osinde (1988) points out, is made up of three elements that is:

- The pronominal class concord
- The connection {-a} (though not in all cases)
- The possessive root.

Using person and number criteria to classify Ekegusii possessive pronoun, six such pronouns are identified. Thus:

TABLE 4: EKEGUSII POSSESSIVE PRONOUNS

PERSON	NUMBER			
	SINGULAR	GLOSS	PLURAL	GLOSS
1 <sup>ST</sup>	-ne	'my'	-ito	'our'
2 <sup>ND</sup>	-o	'your'	-no	'your'
3 <sup>RD</sup>	-je	'his/her'	-bo	'their'

The pronominal/ nominal class concordial prefix determines the prefix attached to the possessive pronoun. The noun thus shows predominance in determining the agreement pattern in the Ekegusii NP. Example:

cl. pref. N.rt

cl. Pref. poss. Rt

20 a) E-Bi- koroto Bi- ane

cl.8.pl shoes

cl.8.Agr. mine

'My shoes'

b) O-mo- isia

o- o

cl.1.sing. boy

cl.1Agr. your

'Your boy'

In example 20,a), the possessive pronoun doesn't possess a pre-prefix.

2.4.2.2 POSSESSION IN THE GENITIVE NP

Ekegusii shows possession by use different prepositions -used to mean 'something belonging to something or somebody else' but literally meaning 'of'. The preposition form in Ekegusii {- a} is used to denote ownership and it links the noun with whatever is owned after it's the noun with whether is owned after its being attached to concordial class prefix. The agreement pattern is still generated by and from the noun. Example :

21.	cl. pref .	N .	rt	cl.Pr.	Prep.	N
a)	Ci -		ombe	ci -	a	Ontita
	cl.10.Agr		cow	cl.10.Agr.	of	Ontita
			'Ontita's cows'			
b)	O-mw -		ana	o		Michieka
	cl.1. sing		child	cl.1.Agr./of		Michieka
			'Michieka's child'			

Depending on the class where the head noun belong, the concordial prefix of the 'possessive preposition" might change in form. The table below demonstrates this:

TABLE 5: POSSESSIVE PREPOSITIONS' WITH GENITIVE NPS

NOUN CLASS	PREPOSITION	
	SINGULAR	PLURAL
Omo-/aba	o-/bwo	Ba
Amo -/eme	o-/bwo	Ya
(E) -ri / a-ma-	ria	A
E-re-/a-ma-	kia	Bia
E- /ci-	ya	Cia
O-ro. / ci	rwa	Cia
A- ka - /eBi	ka	Bia
O- Bo-/ama-	bwa	A
O-ko/a-ma	kwa	A
Aa-	a	A
-me	-	-

#### 2.4.3 NOUN AGREEMENT WITH QUANTIFIERS AND NUMERALS

Quantifiers are grouped together with possessives and demonstratives as modifier determiners in many languages (Chomsky 1991 a). Quantifiers are therefore nominal determiners used to denote quantity. Nyombe (2004), also, groups them together with numerals. However, numerals can be further divided into ordinal and cardinal numerals. In Ekegusii, quantifiers can be definite (numerals) or indefinite.



Example (22) below, shows the first five numerals with 'ten' and 'a hundred' in Ekegusii.

22.	Numeral	Gloss
(a)	E- <sup>4</sup> emo	'one'
(b)	I-Bere	'two'
(c)	I-sato	'three'
(d)	I- <sup>4</sup> <sub>~</sub> ne	'four'
(e)	I-sano	'five'
(f)	I-komi	'ten'
(g)	Ri-gana	'a hundred'

The example (23) below shows some of the indefinite quantifiers on the other hand. These are used to indicate groups of people, objects or things that have been quantified. They include.

23	Quantifier	Gloss
(a)	-onsi	'all'
(b)	-nini	'few'
(c)	-nge	'many'
(d)	-ke	'some'

In Ekegusii, the agreement prefix for definite quantification is only overt for numerals '-mo-' (ones) up to '-sano - isato' (eight). Otherwise the other numeral

starting from 'Kianda' (nine) up to infinity have a zero agreement morpheme. The number agreement morpheme normally depends on the nominal class prefix of the post-modified noun. For example:

	cl. pre.	N. rt	Agr. Pre.	N. rt.
24.	A-ka-	mori	a - ka-	mo
	cl.12,sing	calf	cl.12 .Agr.	one

'One (small) calf'

The different noun classes in Ekegusii thus, have different agreement prefixes added unto the numeral roots that admit the Agreement morphemes.

In determining the noun post modification function in Ekegusii quantifiers also agree with the noun forming a concordial relationship in the agreement prefixes attached to both the noun and the quantifiers roots. Example (25) demonstrates this:

25.	cl.pr.	N.rt.	Agr. Pref.	Quant.rt	<i>gloss</i>
	a)A-	Ba-	nto	a-Ba	-nge
		cl. 2.	pl.person	cl.2.Agr.	many 'many people'
	b) E-bi-	nto	Bi-	onsi	
		cl.8.pl	thing	cl 8.Agr all	'all things'

Just like numerals, the nominal concord with the quantifiers is determined by the noun class prefix. The table below shows the agreement prefixes in quantifiers in the various Ekegusii noun classes.

**TABLE 6: AGREEMENT PREFIXES IN QUANTIFIERS**

NOUN CLASS	NOMINAL PREFIX SING. PLU	QUANTIFIER			
		-onsi ALL	-nini FEW	-nge MANY	-ke SOME
1/2	omo- /abu-	B-onsi	Ba-si- nini	Aba-nge	Ba-ke
3/4	omo- /eme-	y-onsi	Me-si- nini	e-menye	Me-be
5/6	(e) ri - /ama	Onsi	Ma-si- nini	Ama-me	Ma-ke
7/8	ere- /ebi-	Bi-onsi	Bi-si- nini	eBi-nge	Bi-ke
9/10	e-/ci	Bi-onsi	ci-si- nini	Cini-nge	n-ke
11/10	oro-/ci-	ci-onsi	ci-si- nini	Cini-nge	n-ke
12/8	aka-/ama	ci-onsi	Bi-si- nini	Ebi-nge	Bi-ke
14/6	obo-.ama	Bi-onsi	Ma-si- nini	Ama-nge	Ma-ke
15/6	oka-/ ama-	Onsi	Ma-si- nini	Ama-nge	Ma-ke
16	aa-	Onsi	a-si- nini	a-ninge	a-ke
17	-me	-			

From the table above, it can be noted that quantifiers agreement prefixes are determined by plural nominal classes, that is, class 2,4,6,8 10and 16. The only few exceptions are abstract nouns which take the concordial prefixes when they co-occur with the quantifiers.

#### 2.4.4 NOUN ADJECTIVE AGREEMENT

Like demonstratives possessives and quantifiers adjective post modify nouns and thus share agreement features with the modified noun. In as much as they behave like the other determiners the influencing element is the nominal class prefix that is taken up by the modify adjective(s). In the examples below we examine the internal concord in Ekegusii DPS involving adjectives.

	cl. pref.	N.rt.	Agr.	Pref. adj.rt.	gloss
26 a)	omo-		twe	omo -nene	'a big head'
	cl.sing.		head	cl.Agr.big	
b)	a-ma-		gena	ama -ke	
	cl.6.5sing		stone	6.Agr. small	
					'small stones'

#### 2.4.4.1 COMPLEX ADJECTIVES

In this section, this study looks at examples of Ekegusii examples whereby more than one adjective co-occurs with a noun demonstration the DP internal concord with full influence emanating from the noun class prefixes;

*i) A noun with two Adjectives*

27. Omo- te omo- tambe omo-mwamu  
cl.s.sing tree cl.sing. tall cl.Agr. black  
'A tall black tree'

*ii) A noun with three adjectives*

28. E- Ndo e-mbariri e-ntindi E- nsacha  
9Agr lion 9Agr.red 9 Agr,aggressive 9Agr. Male  
'A red aggressive male lion'

*iii) A noun post-modified with four Adjectives*

29. Omo- iseke omo- igweri omo-itebere omo-tambe  
l.Agr girl l Agr. Obedient l.Agr,beautiful l. Agr. Tall  
omo-keresito  
l.Agr.Christian  
'A beautiful, tall obedient Christian girl'

It is important to note at this level that whenever more than four adjectives co-occur in the same NP/DP a conjunction is introduced between the last two adjectives.

## 2.5 SUMMARY

In this chapter, this study has analysed and discussed the morphological structure of the Ekegusii nominal. A few of the classes have been discussed. This analysis brings out class markers as one of the domineering feature of agreement together with number and person which have given this chapter a brief introduction of morphosyntax. The study has singled out the concordial relationship of the constituents in the Ekegusii DP that is modifiers (demonstratives, possessives, quantifiers and adjectives). The noun is dominant in the Ekegusii DP because the class-prefixes of the noun determine the concord/ agreement morpheme in the modifiers.

# SYMMETRY

## 3.0 INTRODUCTION

In the previous chapter, this study examined the classification of the Ekegusii nominal segments and a brief introduction of their occurrence in the grammatical system of agreement in the language. The analysis, particularly, focused on concordial agreement between the NP and its modifiers. In this chapter, the study aims at relating the research objectives with the hypotheses, and most importantly, isolating the similarities between the sentence (the IP) and the DP in Ekegusii. Thus this study delves into ascertaining an understanding of the relationship that exists between the sentence and the determiner phrase in the M.P. Therefore, the two hypotheses of this study that are put to test in this chapter are: establishing the parallel between the IP and DP, and the application of the feature checking and full interpretation principles especially in verbal movement in the sentence. The working of Chomsky's economy principles<sup>7</sup> will also be explored in this chapter.

---

<sup>7</sup> Some of these principles include Procrastinate, Greed, Last Resort and Shortest Move. See Marantz (1995:354).

### 3.1 AGREEMENT IN THE EKEGUSII SENTENCE

Taking the Minimalist Program basic sentence structure, Chomsky (1993:7) also introduced in Chapter 1, Abney (1987) proposes that a parallel between the sentence (IP) and the DP can be established. This study does this by first providing evidence for the existence of agreement in the Ekegusii sentence. Agreement in this case is realised in terms of AGRsP (agreement subject phrase) and AGRoP (agreement object phrase). Chomsky's sentence also comes out as a projection of the verb. This is related to Haegeman's definition of a clause as a

*"[a projection] of a V (VP) dominated by functional projections AGRP and TP."* (1994:609)

In the verb, both the S.A.M and O.A.M are normally a composition of agreement features. The prefixes in a verb standing for the subject agreement and object agreement carry bundles of such features as person, number and class. In (30) below an Ekegusii verb exemplifies this:

30. Ba - mo - ram - i - re  
S.A2 O.A1 V.rt tns Asp

"They have abused him/her."



The subject agreement-marking prefix is {ba-} and the object agreement markers {-mo-} both contain the following features:

- i) Person agreements [3<sup>rd</sup> (third)]
- ii) Class agreement (noun class - 1-2)
- iii) Number agreement<sup>8</sup> (plural).

### 3.1.1 THE SUBJECT AGREEMENT PHRASE (AGRsP) IN EKEGUSII

As noted in chapter one, in the new 'minimalist' basic sentence structure, AGR and TNS are the two abstract features that check the V-root (Haegeman 1996:618). Since AGRP occurs in a higher position than the noun head and the TNS, the nominal subject features are raised to SPEC of AGRsP so as to check case features. Therefore, a typical Ekegusii Agreement subject Phrase (AGRsP) is illustrated in 31 below as evidence for the existence of the phrase (AGRsP) in the language:

31 a.)

Magati	o	-	som	-	I	-	re
S.A1	S.A1		V.rt		tns		Asp

"Magati has read."

---

<sup>8</sup> In a verb the subject dominates the object's number agreement because normally the subject is the doer of the action.

The structure for the sentence above is:

b)

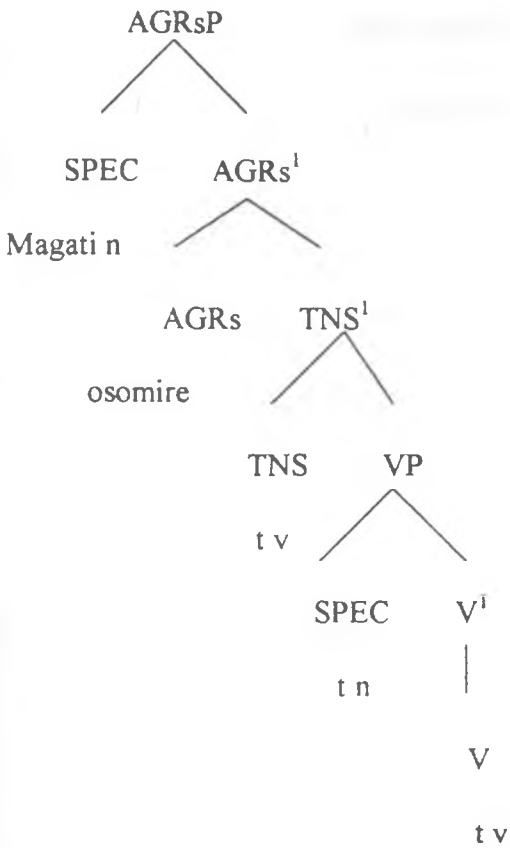

In the structure built above, the nominal subject 'Magati' moves from the SPEC -VP (formerly VP internal subject position) and settles at SPEC-AGRs position where its agreement features of case, number and class are checked. Similarly, the verb 'osomire' moves out of the V landing at TNS-TNS<sup>i</sup> where its tense feature is checked ahead of its movement onto the AGRs-AGRs<sup>i</sup> where the its subject class agreement features are checked.

### 3.1.2 THE AGREEMENT OBJECT PHRASE (AGRO<sub>P</sub>) IN EKEGUSII

Ekegusii, being an agglutinating Bantu language, has an object prefix marker in its verb form or sentence. This calls for the establishment of the AGRO head between the TNS/ and VP nodes in the structure building process. Example (32) below illustrates this:

32 a.)      O      -      mo      -      it      -      e  
               S.A            O.A            V.rt            tns  
               "You beat him/her."

The tree diagram in (6b) below is the structure for the sentence (6a) above:

b)

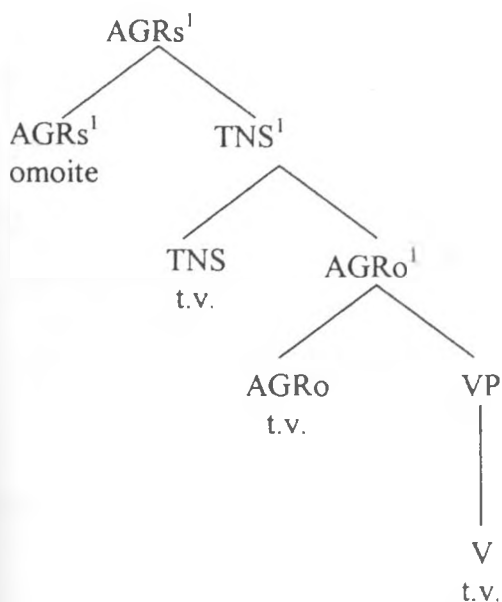

In the structure (6b) above the verb, 'omoite' moves from the V to AGRO-AGRO<sup>1</sup> to check its objective features before moving to the TNS-TNS<sup>1</sup> to check off tense features. The verb moves to the

This study establishes the necessity of verb movement. This movement is meant for feature checking so as to ensure full interpretation of the features such that the resultant surface form at LF and PF is grammatical.

Specifier positions, especially SPEC/AGRs and that of the VP are left out of the structure for they are vacuous especially when the subject and object are covert. Case features for both the subject and object are checked at the SPEC/AGRsP and SPEC/AGRoP subjective/nominative case is checked by moving an overt subject to SPEC/AGRsP [see Magati in example (5)] and objective or accusative case is checked at the SPEC/AGRoP.

### 3.2 MOVEMENT AND CHECKING IN THE EKEGUSII SENTENCE

As a preamble towards unravelling the DP structure in chapter 4, this section examines the morpho-syntax of the Ekegusii simple sentence. The agreement relationship between the sentential constituents (DP subject, verb, DP object) in Ekegusii is established. This analysis is based on the basic sentence structure in the MP (Chomsky 1995) introduced in chapter 1.

This analysis notes that indeed the MP basic sentence structure is best accommodated by the morpho-syntax of Ekegusii.

It is in the structure building process that both the noun and verb have to undergo *move*<sup>9</sup> for the purpose of feature checking. In order to check both subjective and objective case features, the noun (nominal) moves to the (SPEC)ifier positions of AGRs and AGRO. Since verbs, as Cook and Newson (1996: 328) put it,

*"are inserted from the lexicon complete with all their features, which need to be checked off at some stage in the derivation to avoid these grammatical features surviving to the interface levels",*

they move to the TNS/TNS<sup>1</sup> so as to check the tense feature.

Being an SVO language, that is rich morphologically, the agreement of constituents of the Ekegusii sentence in the verb (subject and object prefix markers, the verb root or tense/aspect marker among others) is worth a minimalist analysis. Example (33) shows two examples of sentences from Ekegusii.

33. a.) E-bi-tuma bi - a - rir- e e-mbori.  
 DP subject S.A Asp V.rt. tnsDP object  
 "The maize have eaten the goat" - literally.

<sup>9</sup> Cook & Newson 1996: 325; Newmeyer 1998.

b) o-mwana one o - minyok - i - re.

Dp subject Poss.A S.A v.rt tns Asp

"My child has ran."

(33. a & b) above show examples of a transitive and intransitive sentences in Ekegusii. In both cases, agreement features are commonplace. In the production of example (33a), the derivation of structure (34) takes time to be built following the dictates of the economy principles: Shortest Move, Greed and Procrastinate that constrains a computation thus delaying the action of greed of movement of the verb, object or subject.

*Shortest Move* dictates that constituents that constituents should move to the first and relevant landing site from their source position. In support of this argument, Marantz (1995: 355) argues,

*"heads ... should be prohibited by Shortest Move from skipping over any head position 'between', in the relevant sense, the position they start in and the targeted landing site".*

*Greed*, on the other hand, is a constraint that postulates that a process affects an element so as to satisfy the requirement of that element so as to satisfy the requirement of that element. For instance, to check a verb feature, a verb needs to move to

TNS and AGRs, not vice versa. Marantz clarifies this by arguing that the principle states that

"a constituent may not move to satisfy the needs of the moving constituent; movement is motivated for selfish reasons, to satisfy the needs of the moving constituent" <sup>10</sup>.

On its part, the principle of *Procrastinate* delays movement until after spell out. The principle thus prevents crashing of constructions by ensuring that such movements do not affect the PF.

Movement of elements in example 33 a) above, considering the economy principles mentioned above, will produce the structure (34) below:

---

<sup>10</sup> This is in Marantz' article "The Minimalist Program" in Webelhuth (1995) *Government and Binding Theory and the Minimalist Program*. P.358.

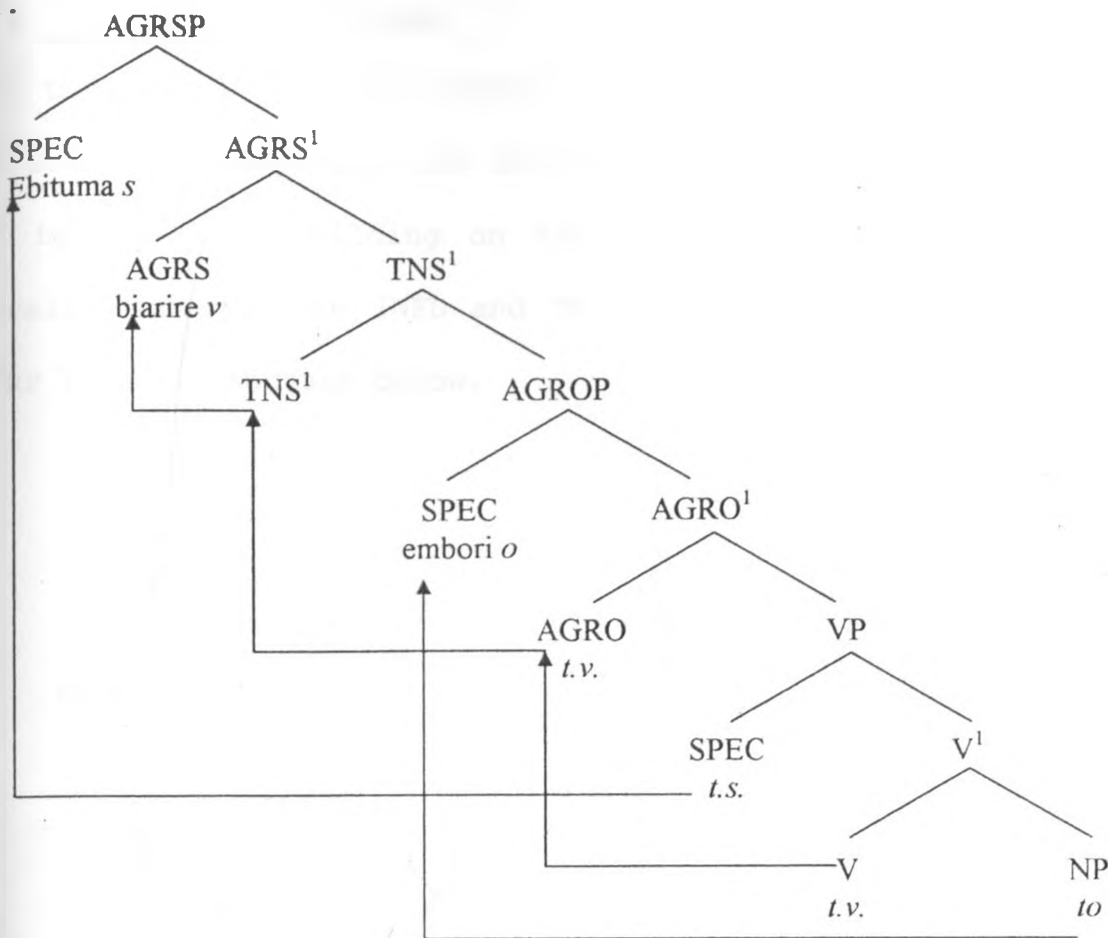

In the structure above, 'Ebituma' settles at SPEC/AGRS<sub>P</sub> from spec/VP whereas 'embori' settles at SPEC/AGROP from NP/A. These two are overt subject object that move to check nominative and accusative cases respectively. The verb moves from V/v to AGRO/AGRO<sup>i</sup> to check its object agreement features and then to TNS/TNS<sup>i</sup> to check its tense features and at last settles at AGRS/AGRS<sup>i</sup> where it checks off its subject agreement features.



### 3.3 THE EKEGUSII DP SCHEMA

For the purpose of this chapter, a tentative Ekegusii DP structure at least providing for the concord (agreement of elements) in the DP is generated building on the Abney (1987) suggestion on the parallel between the INFL and DP that sees the projection of the AGRP in the structure below.

35..

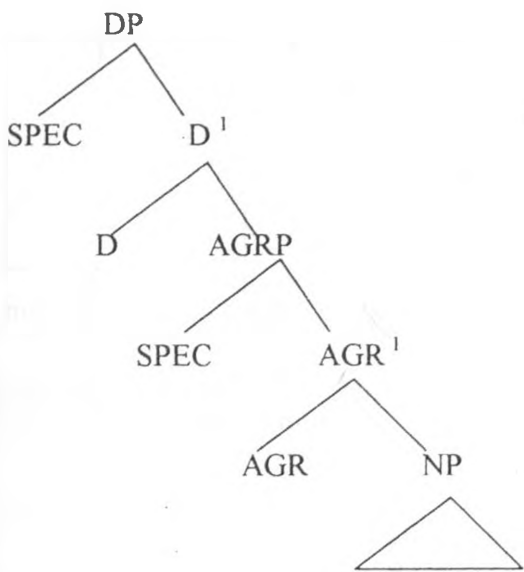

This DP structure is a further development of the Abney (1987) DP Hypothesis, from which the following phrase structures can be generated in Ekegusii.

36 a.)

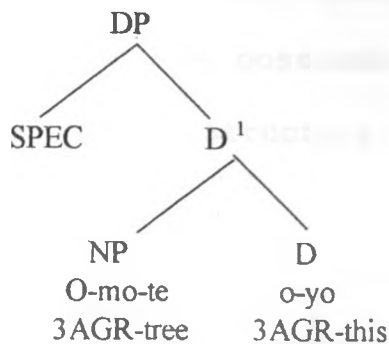

b.)

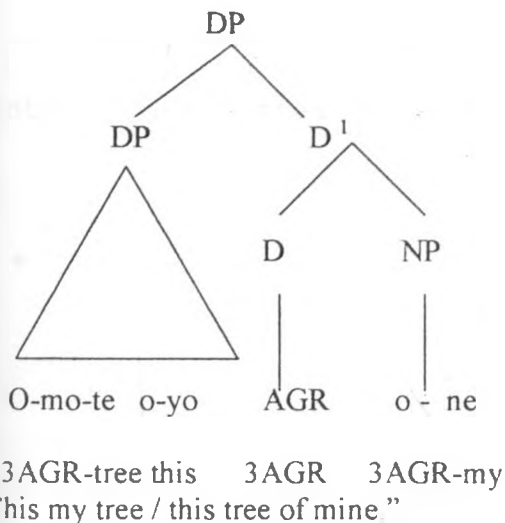

In the above examples (a) is literally embedded in (b). The above structures (2 a. and b.) thus culminate into what this study considers the 'ideal' DP structure in (1) as at this point. It is clear that the concordial agreement in the Ekegusii DP in class and number, whether it is between the noun complement and the demonstrative "oyo" or the possessive "one" with the already modified noun in the phase "omote oyo", is indeed imbedded in the DP (see structure 1 above). In the tree diagrams, the NP turns out to be "a projection of N dominated by a functional

projection"<sup>11</sup>. The Agr under D accounts for the agreement that exists between the possessed 'omote oyo' and the possessive. Note that the DP structure is the major concern of the following chapter.

### 3.4 SCHEMATIC RELATIONSHIP BETWEEN THE EKEGUSII DP AND SENTENCE

Taking the two minimalist structures (Ekegusii DP and sentence), a series of deductions can be made:

- The DP and *INFL* of the sentence in Ekegusii are projections of functional categories from a lexical category, which is the NP for the DP and the VP for the sentence.
- Both the DP and *INF* of the sentence are projections of the N (NP) and V (VP) respectively.
- From the Abney (1987) assumptions of the DP analysis, there is a parallel relationship that is drawn between the DP-NP at the DP level and the IP<sup>12</sup> -VP at the sentence level.
- Agreement forms the core of the two functional phrases that is DP and IP for it features prominent in both. In the sentence, agreement of subject and object is crucial with the verb having to move to check these agreement features and tense features ahead of spell out. Similarly, in the DP, there is concordial agreement and the SPEC of AGRP is

---

<sup>11</sup>This is a conclusion by Haegeman (1994:609) after analysis of the DP Hypothesis (Abney 1987).

thus the site for possessives and other nominal modifiers. The Number and Quantifier Phrases may also be generated in the DP as functional categories. This argument is supported by Ritter (1992) and Kaviti (2004) especially on the Number phrase and Nyombe (2004) and Guisti (1992) who argue for a QP.

Recent literature has attributed some properties to the DP. Grimshaw (1991) argues that the DP

*"is a perfect projection of N in a fashion parallel to that in which CP is a perfect projection of V"<sup>12</sup>.*

On the same breath, Szabolcsi (1992) also agrees to the claim that DP and IP perform "the function of saturating the predicate, namely turning a predicate (VP or NP) into an argument"<sup>13</sup>.

In her analysis of the Chinese DP, though, Tang generates a k(classifier) phrase (KP)<sup>15</sup> in place of agreement phrase. She thus comes up with two major similarities:

---

<sup>12</sup> The IP is later split in the Pollock (1989) Split – INFL hypothesis that is also later developed by Chomsky coming up with such functional categories as AGRsP, TNS and AGRoP out of the IP.

<sup>13</sup> This is in an article by Guisti (1992) "Heads and Modifiers among Determiners. Evidence from Romanian and German" in, *Working Papers in Linguistics*. 3. CL1 p.12.

<sup>14</sup> DP and CP are extended projections of the NP and VP respectively.

i. Both the sentence and DP contain two functional projections (that is CP-IP and DP-KP) and one lexical projection (that is NP and VP). The last projection is the lexical projection and higher in the tree there are functional projections.

ii. Both the K and INFL heads contain lexical elements (for example numerals and modals) and agreement and agreement-like elements (classifiers and AGR).

Tang's analysis predicts the bound nature of agreement features. She says that

*"at the sentence level, the bound morpheme AGR cannot occur alone and must be attached to some other element"<sup>15</sup>.*

This implies that for the V to receive the AGR, it ought to be raised higher in the tree.

#### SUMMARY

The discussion in this chapter gives a cross-examination of the DP and the sentence in Ekegusii. The study further draws parallels between the two with some more evidence in other related natural languages studied by other linguists across the world. This chapter also gives a slight feel of the morpho-

---

<sup>15</sup> The KP in the Chinese DP functions like the AGRP and other functional phrases.

syntax of the Ekegusii sentence showing the overt movement of constituents in the derivation process. The analysis of movement of elements in the sentence in the last section of the chapter is an eye-opener into trying to relate movement of elements in the sentence to that of the DP whose structure is explored at length in the next chapter.

---

<sup>16</sup> From Tang (1988) "A Note on the DP Analysis of the Chinese Noun Phrase". P.345.

## CHAPTER FOUR: DETERMINER PHRASE ANALYSIS

### 4.0 INTRODUCTION

In this chapter, this study establishes the structure of the Ekegusii DP. This analysis goes further to investigate the domain of the NP in the Ekegusii DP. Having looked at the classification of the Ekegusii nominal segments and their properties within the grammatical agreement and/or concord in the language, this chapter will narrow itself down to the ascertainment of the order of post-modifiers of the noun or nominal element in the Ekegusii DP.

The establishment of the Ekegusii DP structure under the MP will be a key pointer to the much emphasised similarity between the DP and IP. This study will also locate the position of the widespread morphological agreement (AGR) and its role in the DP structure. It is also paramount for this chapter to show the various features that are checked and in which positions in the structure building process of the Ekegusii DP. It is important to note that this determiner phrase analysis builds on the assumption that DP is a functional projection of the noun as argued later in this chapter.

#### 4.1 THE DP HYPOTHESIS AS MOTIVATION FOR DP ANALYSIS

The DP Hypothesis was an attempt and indeed a proposal by Abney (1987), who, after working on Turkish, Hungarian and English data, came up with a proposal that there is an AGR functional head in the NP. Abney analogised that just like the clausal INFL-head, the NP also can have its equivalent and this was to be the Det(erminer)- head that forms the functional category - DP. It is with this background and initiative by Abney that saw the birth of the DP with the D-head as its functional element that has selectional properties that enable it to select the NP complement or stand on its own<sup>7</sup>.

The Ekegusii NP thus is not left out in the argument that having projected the functional DP, it turns out to be a complement in the structure. Thus

37.

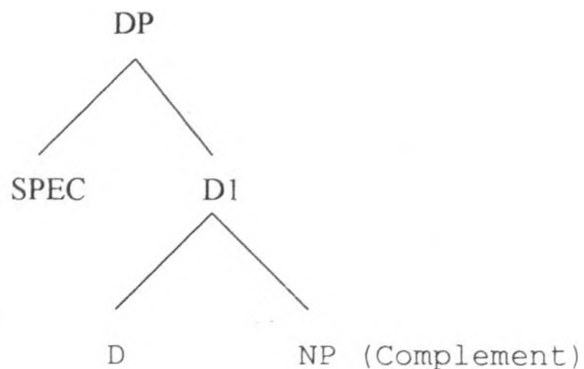

<sup>7</sup> Functional elements may or may not take a specifier.



Adopting the Abney (1987) framework, the Ekegusii DP could thus generate a structure such as (38).

38.

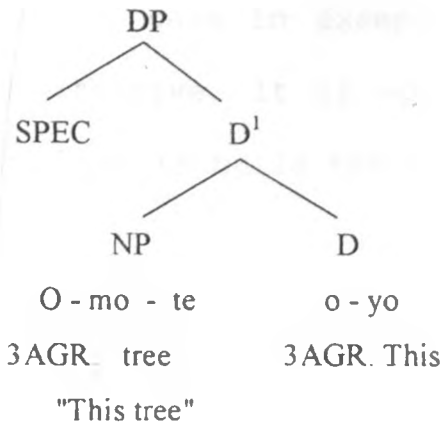

The argument for AGR and determiners found in the D of a DP as a parallel of the AGR and TNS in a sentence can also generate a structure such as the one in (39) below (following structure (38) above).

39.

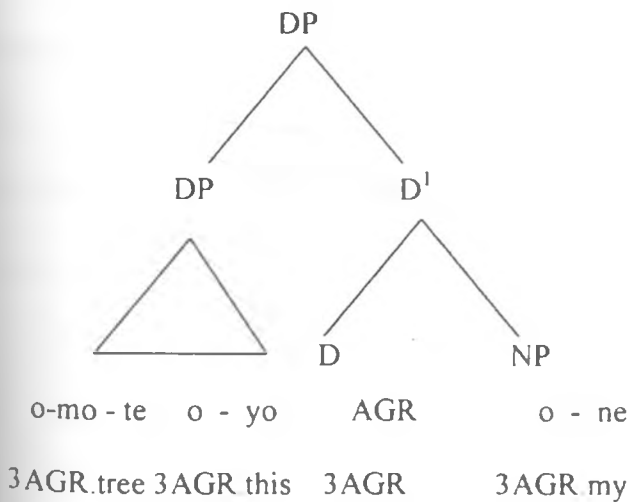

"This tree of mine (this my tree)"

In building the structures (38 & 39) above, it is important to note the difference between the two. Example 39 has a possessive modifier showing agreement between the possessed and the possessor (possessive) - necessitating the AGR on the D head<sup>18</sup>. This is not the case in example 38 which has a noun modified with a demonstrative. It is worth to note that at this level, this study is yet to build the Ekegusii DP.

In the DP analysis, this study acknowledges the Abney (1987) and Longobardi (1994) argument for the uniform application of the DP Hypothesis assumptions within nominal syntax thus seeing the generation of null determiners. Basically, these null determiners are empty determiners which when used with nominals make bare nominals that is nouns or nominal expressions that do not have modifying constituents like the article for example (Radford 1997:152). In the literature on null determiners, Radford (1997), Nyombe (2004) and Kaviti (2004) in studying such languages as English, Bari and Kikamba respectively also take up this argument. Null determiners or what Kaviti (2004:163), following Radford (1997:152) call *bare nominals* are normally symbolised as  $\phi$ . This argument generates a structure (40) below:

---

<sup>18</sup> This is equivalent to the English treatment of the possessive form: ( 's ) as in Mary's blouse.

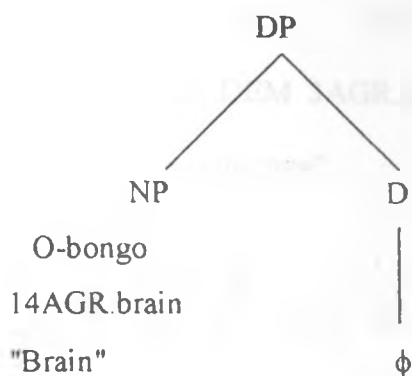

This study, however does not take up this argument because it doesn't relate to Ekegusii as such.

#### 4.2 THE DETERMINER PHRASE

In analysing the Ekegusii DP, this study adopts the Abney (1987) approach but later makes a series of changes by way of recommendations. Following the current trends in the syntax of various languages across the world, as Guisti (1992), puts it there is evidence that within the DP there is a number of elements that modify the Noun. The NP now exists as a complement of D in the DP. In Ekegusii, as noted earlier in this study, demonstratives, possessives and quantifiers together with adjectives are all modifiers of N in the DP. Of all the Ekegusii nominal modifiers, the demonstratives are marked because three of them can modify a noun towards the right as in example (41) below:

41.

O-mo-te      oy-o      oy-o      o-yo

3AGR.tree 3AGR.DEM 3AGR.DEM 3AGR.DEM

“This specific tree”

Such a DP (41above) will elicit a structure demanding that there be three intermediate agreement phrases whose spec positions will be targets of movement of the demonstratives from the N. The noun complement 'omote' also moves head to head up the tree, crossing over the SPEC-AGRP - positions, and settles at the D up in the tree. The structure that emerges is shown in (42) below:

42. (a)

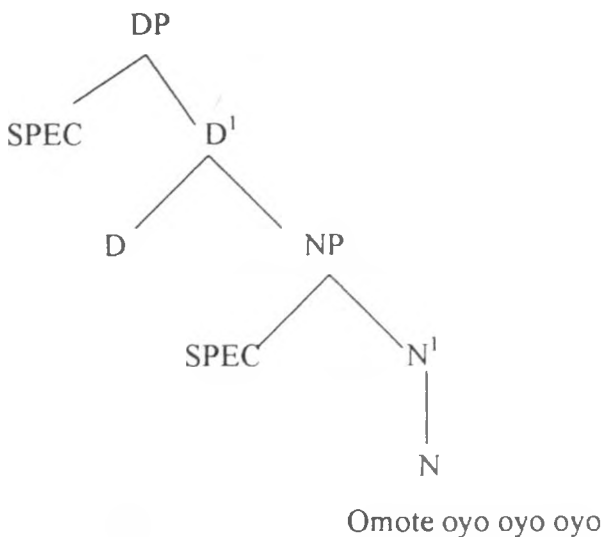

(b)

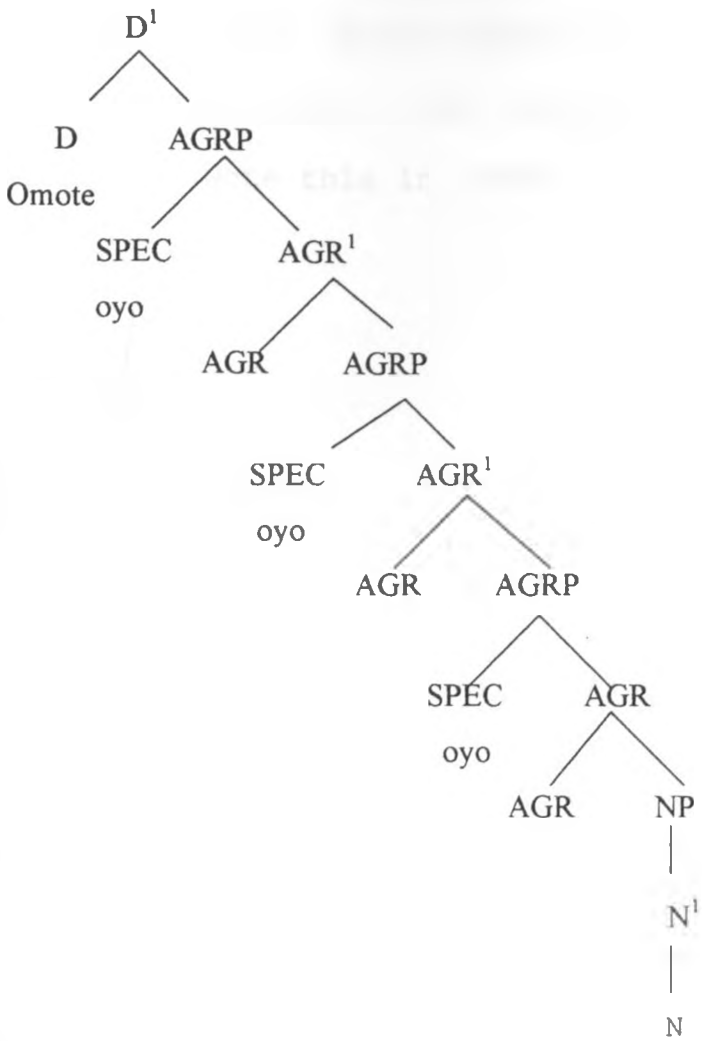

In the structure built above, the AGR node accounts for the class agreement feature. From example, (42a) and (38) above, this study notes that the Ekegusii DP is normally right-branching before the derivation starts to take place. (42 b) is a result of movement of both the noun complement and the demonstratives for checking purposes. The justification of the selection of the noun and the demonstrative(s) is the parallel between the sentence (IP) and DP addressed in chapter 3. This study thus proposes that all the determiners (modifiers of the noun are generated at the N-head before any movement or the structure starts to be built. The SPEC -DP in (42b) above is not projected as constrained by Chomsky (1995) Economy principle.

It is, however, worth noting that projecting pre-modifying demonstratives results in ungrammatical thus unacceptable constructions. Note this in example (43) below:

(43)

a) O-mo-ibi  
1AGR thief  
'Thief'

b) \*O-yo                    o-mo - ibi  
1AGR.DEM    1AGR thief  
'This thief'

c) O-mo-ibi            o-yo  
1AGR.thief    1AGR.DEM  
'This thief'

d) O-mo-ibi    o-yo            o-yo  
1AGR thief    1AGR.DEM    1GR.DEM  
'This very thief'

From the above examples, Ekegusii DP takes the noun-initial order based on the Headedness Parameter of the Principles and Parameters in Chomsky's search for a Universal Grammar (UG) theory. In Ekegusii, the demonstrative can be used to show definiteness; however, if the argument for its indefinite

specification of a noun can be brought forth, it will be more of a semantics argument, which is extraneous to this study. Therefore, example 43(b) is neither grammatical nor acceptable because the projection of the SPEC DP as a landing site for the demonstrative 'oyo' will go against the Ekegusii noun-initial order of its Headedness Parameter, which allows for the specification/modification of the noun towards the right of the noun only in the derivation of example (43c and d), a similar structure-building as (42) above will occur but (43) will have a single intermediate agreement phrase whereas (43b) will need two, so as to assist in the checking of the agreement features. Since the noun 'omoibi' in (43a) above has no modifier its structure, with which it ought to agree in number and class, it needs not have an AGRP<sup>19</sup>.

Although Abney (1987) suggests that, the agreement features (number and class for Ekegusii) are base generated at D, which is the head of the DP, the projection of agreement phrases instantiates the claim that, the spec of these phrases (AGRPs) is the landing site; after the agreement features have been checked at the head. As proposed in the following section, spec positions of the other agreement functional projections in the DP are only landing sites.

---

<sup>19</sup> Its agreement features will be checked *in situ*.

#### 4.3 AGREEMENT OF ELEMENTS IN THE EKEGUSII DP

##### 4.3.1 POSSESSIVES

Just like the above modifiers (demonstratives), possessives also have a similar distribution in the Ekegusii DP. Their uniqueness is demonstrated in example (44) below:

44.

a) a-ba-na                      b-ane  
2AGR children              2AGR.POS              "My children"

b) \* bane              a-ba-na  
2AGR.POS      2AGR children  
"My children"

c) a-ba-na                      ba                      Mogusii  
2AGR children 2AGR of                      Mogusii  
"Mogusii's children"

Notice that, the example in (44b) becomes ungrammatical when the possessive pre-modifiers (precedes) the noun complement which contravenes the structure of the Ekegusii DP. Since Ekegusii doesn't project SPEC-DP so as to accommodate the possessive 'bane' in (b) above, it is ill-formed (44a) needs an AGRP whose SPEC/head will check the agreement features of both the noun 'abana' and the possessive 'bane'.



In (44c) above, the noun 'abana' agrees with the genitive 'ba'<sup>20</sup>, therefore, in the structure AGRP is built to check its agreement features. The genitive noun moves from N to the agreement head to check its agreement features then to SPEC- AGRP. The other noun 'Mogusii' remains in situ lower in the tree. This is shown diagrammatically below:

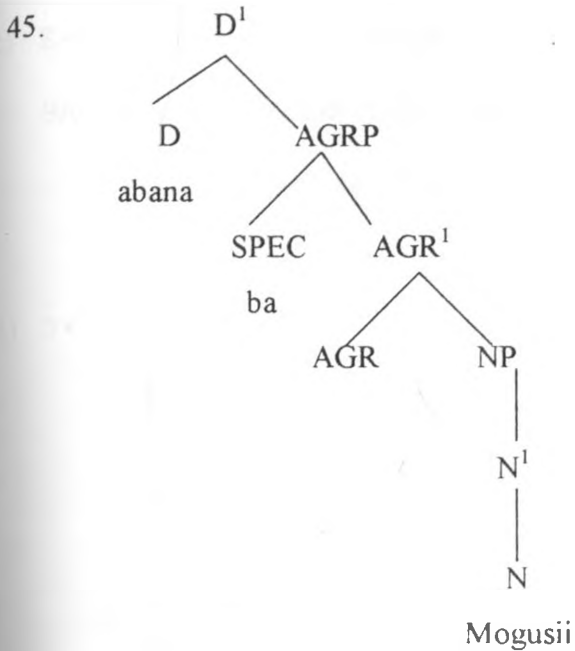

#### 4.3.2. AGREEMENT OF DEMONSTRATIVE AND POSSESSIVES:

The Ekegusii DP allows co-occurrence of demonstratives and possessives both as modifiers of the N- complement. The examples in 46 below are either present or not in the language:

<sup>20</sup> It is the possessed and the genitive that should agree but not the possessor and the genitive.

46. a) E-sese e-ye y-ane  
AGR.dog 9AGR.DEM 9AGR.POS

'This dog of mine / this my dog'

b) \* E-sese y-ane e-ye  
9AGRdog 9AGR.POS 9AGR.DEM

"My dog this" OR 'my dog is here'

c) E-sese e-ye e-ye yane  
9AGRdog 9AGR.DEM 9AGR.DEM 9AGR.poss

'This specific dog of mine'

d) ?\* E-sese e-ye y-ane e-ye  
9AGRdog 9AGR.DEM 9AGR.POS 9AGR.DEM

'My dog is here'

It is quite interesting to note that (46) above, (b and d) are realised as sentences in the language and not as determiner phrases because structurally, they appear as DPs. This is quite strange but it is at PF that is depending on the pronunciation and LF (based on what a speaker wants to put across) that this comes into play. The argument presented here is for the DP thus this study avoids venturing into these DPs as sentences, at least to avoid any confusion. (46a and c) are acceptable and thus grammatical in Ekegusii. The noun in (a) is post-modified by a demonstrative and a possessive (c) is post-modified by the demonstratives and a possessive. From these two examples, this

study notes that whenever demonstratives and possessives co-occur, the Ekegusii noun tends to select the demonstrative first before the possessive.

In as much as one will tend to think that the structure-building will be complicated, each of these elements modifying the N-complement together with it (the noun) moves up the tree. The noun moves head to head to D, whereas the modifiers move to respective spec AGRP positions in the tree triggering Spec - head agreement. In the process, number and class agreement features are checked.

This section has shown how the various positions are targets of movement of demonstratives, possessives and genitives in the Ekegusii DP. The core of it all, AGRP is generated for the purpose of checking agreement features that is between the modifiers and the noun.

#### **4.4. QUANTIFIERS**

Although this study has mentioned above that quantifiers need to be looked at as determiners (modifiers of the N-complement), there is need to trace the argument from what other linguists say. Abney (1987) and Szabolcsi (1991) argue that quantities cannot be heads of functional projections. In the literature, Nyombe (2004) examines quantifiers under the group of numerals and quantifiers. Notice how cardinal numerals co-occur with nouns and other determiners in Ekegusii:

47) a.) O- mo-nto      o-yo-mo

1AGR.person      1AGR.NUM

'One person'

b.) A-ba-iseke      ba-bere

2AGR.girls      2AGR.NUM

'Two girls'

c) A-ba - nto      a-ba      ba-bere

2AGR.people      2AGR.DEM      2AGR.NUM

'These two people'

d) A-ba-nto      a-ba      ba-ne      ba-bere

2AGR.people      2AGR.DEM      2AGR.POS      2AGR.NUM

"These two people of mine"

The co-occurrence above is proof that numerals also participate in the agreement pattern in the Ekegusii DP. This study adopts the argument that an AGRP is generated a functional category in handling numerals. SPEC of this AGRP is a target of movement of the numeral. Using the above data, one expects the AGRP to be the third most imbedded functional phrase from D high in the tree. In a while, this study demonstrates this in a tree structure (49). In Ekegusii, quantifiers have a function similar to that of adjectives - modifying the N-complement. Example (48) shows this.

48. a) E-bi - nto bi-onsi

8AGR things 8AGR.Q

"All things"

b) E-bi - nto e - bi bi-onsi

8AGR things 8AGR.DEM 8AGR.Q

"All these things"

c) \*E-bi - nto bi-onsi e-bi

8AGR things 8AGR.Q 8AGR.DEM

'All things these'

d) E-bi - nto e-bi biane bionsi

8AGR. Things 8AGR.DEM 8AGR.poss 8AGR. Q

"All these things of mine"

e) \*E-bi - nto bi-onsi e-bi bi-ane

8AGR.things 8AGR Q 8AGR.DEM 8AGR.POS

f) E-bi-nto e-bi bi-ane bi-tato bi-onsi

8AGR. things 8AGR.DEM 8AGR.POS 8AGR.NUM 8AGR.Q

'All thes three things of mine'

g) \*E-bi-nto e-bi bi-ane bi-onsi bi-tato

8AGR. Things 8AGRDEM 8AGR.POS 8AGRQ 8AGRNUM

'All these three things of mine'

From the data in 48 above, there seems to be an accepted order of occurrence of elements in an Ekegusii DP, which has a quantifier, numeral, possessive and demonstrative. What can be made out of the example is that the elements are selected out of the NP lower in the tree, one after the other beginning with the demonstrative that moves spec to spec to settle at SPEC AGRP in the highest AGRP, followed by the possessive, then the numeral and lastly the quantifier. The noun then moves from N across SPEC-AGRPs onto the D checking its agreement features with each and every modifier now at these spec positions. The structure below represents (48f) in a tree (49).

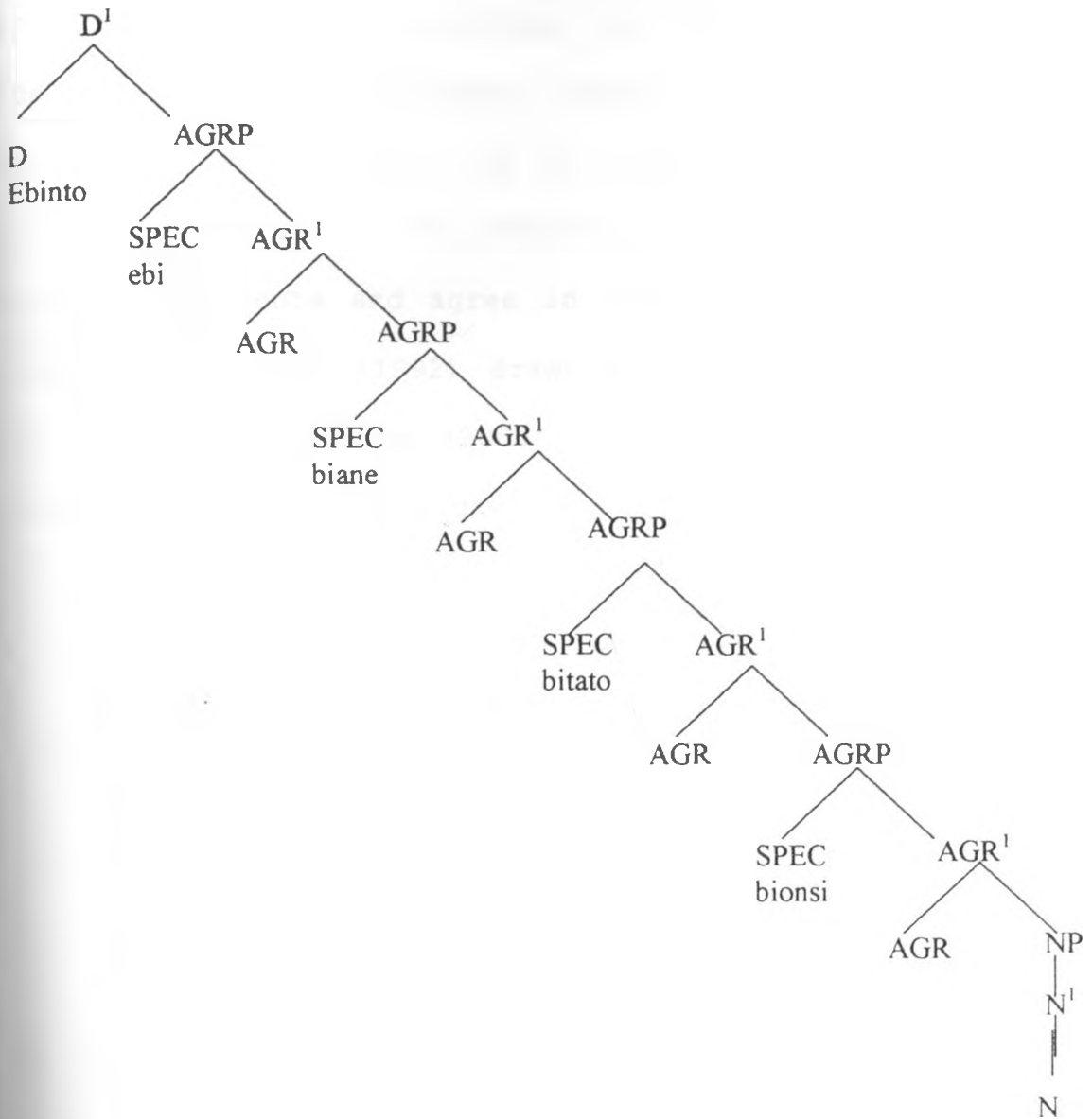

The second lowest and lowest AGRP projected in the structure above are both functional heads<sup>21</sup> to accommodate number and the quantifier.

<sup>21</sup> These categories also function like the sentential TNS and /or AGRP.

#### 4.5. ADJECTIVES

In the Ekegusii DP, adjectives in behave just like the other 'determiners'. This statement, however, excludes their recursive character<sup>22</sup> because the aim of this section is to show that indeed adjectives in the Ekegusii DP can co-occur with other modifying elements and agree in class and number with the noun complement. Guisti (1992) draws a parallel between quantifiers and adjectives. Nyombe (2004) also in computing the adjective phrases in the Bari DP argues:

*"because adjectives have same structural characteristic as demonstratives- adjectival phrases should be amenable to the same treatment as demonstratives and possessives"*  
(2004:35).

In Ekegusii DP, the various instances where the adjective may or may not occur are exemplified in (50) below:

50.

- a)       A-ma-iso               a-ma-ya  
          6AGR.eyes       6AGR.nice  
          'Nice eyes'

<sup>22</sup> Recursiveness of adjectives entails their ability to be heaped upon each other without necessarily making a construction ungrammatical. Their ordering is, however, not random but its dictated by the grammatical order of adjectives in the language. Polome (1967:143) supports this, relative to the ordering of determiners, by pointing out that the order depends on the relatedness or closeness of semantic association of the determiners/adjectives *vis a vis* the 'N-head'.



- b) \* A-ma-ya                    a-ma- iso  
       6AGR.nice    6AGR.eyes  
       'Nice eyes'
- c) A - ma -iso    a-ya    a -ma-ya  
       6 AGR.eyes    6AGR.DEM    6AGR.nice  
       'These nice eyes'
- d) A-ma-iso        a-ne            a-ma-ya  
       6AGR.eyes    6AGR.POS       6AGR.nice  
       'My nice eyes'
- e) A-ma-iso        a-ya            a-ito    a-ne    a-ma-bariri o-nsi  
       6AGR.eyes6AGR.DEM 6AGR.POS6AGR.NUM 6AGR.ADJ    6AGR.Q  
       'All these four red eyes of ours'
- f) \*A-ma-iso    a-ma-bariri    a-ya    a-ito            a-ne    o-nsi  
       6AGR.eyes 6AGR.ADJ 6AGR.DEM 6AGR.POS 6AGR.NUM 6AGR.Q  
       'All these four red eyes of ours'
- f) \*A-ma-iso a-ya    a-ito    a-ne    o-nsi    a-ma-bariri  
       6AGR.eyes 6AGR.DEM 6AGR.POS 6AGR.NUM 6AGR.Q 6AGR.ADJ  
       'All these four red eyes of ours'

In the above example, the unacceptability of (50 b,f&g) together with the ordering of the acceptable examples from (a) to (e)

confirm that like other Ekegusii nominal modifiers, targets a specific position in the structure- building especially when they co-occur with demonstrative(s), possessive(s), numeral(s) and quantifier(s). Therefore from the data provided, for the structure to be grammatical (have full interpretation), from the NP head where it is combined with the other determiners before movement for the checking of agreement features, the adjectives target the spec of the second lowest functional (Agreement Phrase) category. It is the spec of this AGRP that selects the ADJ before the noun moves up the tree head to head thus triggering head spec agreement. If the adjective is selected to any other position the structure crashes-this explains the ungrammaticality of (f & g) above.

#### 4.6 SUMMARY

In this chapter, this study has analysed the Ekegusii DP exploring through some of the modifiers of the noun. The noun (NP) in this case is analysed as a complement of the determiner (DP) - in fact in morpho-syntax terms, the DP is a functional projection of the NP. This is likened to the IP which is a functional projection of the VP. This study has further shown how the various modifiers of the noun agree with it in number and class and tried to account for the same. Just like in a sentence where elements are generated in the VP ahead of movement for checking as demonstrated in chapter three, the noun and its determiners(modifying elements) are all generated in the NP and each targets different positions in the structure building. Whereas the noun moves head to head up to the D head that is empty the determiners target the different spec positions of the various intermediate functional projections between the DP and NP.

## CHAPTER FIVE: CONCLUSION

This study aimed at ascertaining the applicability of the M.P. in analysing the Ekegusii Determiner phrase so as to be able to establish the symmetry that exists between the Ekegusii sentential agreement with the concord in the DP.

In so doing the function of the agreement comes out clearly. This was done by analysing Ekegusii data, first through an exploration of the Ekegusii noun class system and modifiers of the noun, generally (chapter 2) and secondly, by examining the morphosyntax of the Ekegusii sentence relative to the Ekegusii DP (chapter 3) Consequently, a critical analysis of the Ekegusii DP under the MP sums up the study (chapter 4)

From the study, the following conclusions are established:

- ❖ The principles of feature checking and full interpretation in the minimalist program are mutually crucial in ensuring that Ekegusii constructions (DP and sentence) are grammatical (converge). This emphasises the fact that the MP is adequate in Ekegusii DP and sentential (verbal) analysis.
- ❖ The Agreement system in Ekegusii is best accounted for by feature checking. In a sentence, abstract accusative and nominative case features are checked by noun movement and tense features are checked by verb movement. Subject and

object agreement features (number, case and person) are also checked before spell-out. In the Ekegusii DP, the movement of the elements is aimed at checking agreement that is between the noun and its modifiers or what this study broadly labels determiners.

- ❖ The Ekegusii NP is headed by a functional category, the DP. The NP in this case is a lexical complement of the DP. In the Ekegusii DP structure built discussed in this study, internal concord is evident in the various intermediate functional phrases between the DP and NP.

Movement of elements across SPEC-AGRPs and the other functional categories checks agreement features between the determiners and the noun.

- ❖ The Ekegusii sentence conforms to the proposed MP sentence structure Chomsky(1993;1995)
- ❖ Both the Ekegusii sentence and DP are headed by functional categories and in both AGRPs are manifest.

## RECOMMENDATIONS

From this study, several issues demand the attention of future and further research. Some of these include:

- The analysis of the morpho-syntax of agreement in the Ekegusii complex sentence.

- An extended analysis of the Ekegusii determiner phrase that explores all that happens in clausal Determiner phrases.
- The possibility of the Ekegusii noun class system having a determiner in the class markers.
- A minimalist account of empty categories like null determiners if indeed they exist in the MP.

## REFERENCES

- Abney, S. (1987) *The English Noun Phrase in its Sentential Aspect* Ph.D. Dissertation. Cambridge, Mass: MIT
- Bleek, W. H. (1971) 1827-2875, *A Comparative Grammar of South African Languages*. Farnborough Gregg.
- Aitchison, J (1999) *Linguistics: An Introduction* (5<sup>th</sup> ed.) London: Hodder & Stoughton Educational
- Borsley, R. (1999) *Syntactic Theory: A Unified Approach*
- Chomsky, N. (1957) *Syntactic Structures*. The Hague: Mouton
- (1965) *Aspects of Theory of Syntax*, Cambridge Mass: MIT
- (1981) *Lectures on Government and Binding* New York: Mouton de Gruyter
- (1989) "Some Notes on Economy of Derivation and Representation", *MIT Working Papers in Linguistics* 10: 43-74.
- (1991a) Linguistics and Adjacent Fields: a Personal View. In A. Kasher (ed.), *The Chomskyan Turn*. Oxford: Blackwell, 5-23.

- \_\_\_\_\_ (1993) "A Minimalist Program for Linguistic Theory"  
*MIT Occasional Papers in Linguistics* in Hale, K and Keyser, S.J  
(eds) *The View from Building 20: Essay in Linguistic in Honor of  
Sylvain Bromberger*. Cambridge, Mass: MIT.
- \_\_\_\_\_ (1994) *The Minimalist Program. Current Studies In Linguistics* 28.Mass.:  
MIT
- Cook, V & Newson, M (1996) *Chomsky's Universal Grammar: An Introduction*. Oxford :  
Blackwell Publishers.
- Cowper, E.A. (1992) *A Concise Introduction to Syntactic Theory: The Government and  
Binding Approach*. Chicago, London: The University of Chicago  
Press.
- Franks, S (2000) "An Interarboreal Analysis of Bulgarian DPs" Indiana University
- Gesare, H.L (1992) *A Morphological Typology of Ekegusii in a Structure Framework*  
Unpublished MA Dissertation UON.
- Guisti, G (1992) 'Heads and Modifiers Among Determiners: Evidence From  
Romanian and German.' *Working Papers in Linguistics* 3 ,  
CL1 University of Venice
- Guthrie, M (1948) *The Classification of Bantu Languages*. Famborough, England:  
The Gregg Press.



- (1970 a)      *Gender, Number and Person in Bantu Languages*” in *Collected Papers\_on Bantu Linguistics*. Westmead: Gregg International Publication Limited.
- (1970 b)      “Observations on Nominal Classes in Bantu Linguistics. “*Collected Papers on Bantu Linguistics*. Westmead: Gregg International Publication Limited.
- Haegeman (1994)      *Introduction to Government and Binding Theory*. Oxford: Blackwell Publication Limited.
- Horrocks, G (1989)      *Generative Grammar*. London, New York: Longman.
- Hurford, JR, Student – Kennedy, M & Knight,C (eds) (1998) *Approaches to the Evolution of Language*. Cambridge: CUP
- Ingonga, L.I (1991)      *A Comparative Study of Ekegusii Luloogoli and Lwitakho; The Phonological, Lexical and Morpho-syntactic Structures*. Unpublished MA Dissertation. KU
- Kaviti L.K (2004)      A Minimalist Perspective of the Principles and Parameters in Kikamba Morpho-syntax. Unpublished PhD. Dissertation UON.
- Leech, G & Svartvik, J (1994) *A Communicative Grammar of English*. (2<sup>nd</sup> ed.) London and New York: Longman

- Longohardi, G (1994) 'Reference and Proper Names', *Linguistic Inquiry* 25: 609-66.
- Mabururu, TM (1994) *A Comparative Study of Ekegusii and Kikuria Morphosyntactic Features*. Unpublished MA Dissertation . KU.
- Mayaka, BA (2000) *The Structure of Ekegusii Sentences: A Transformational Generative Approach* Unpublished B A Dissertation UON
- Mboga, C. (1989) *A Syntactic Analysis of the Simple Sentence in Ekegusii*. Unpublished M.A. Dissertation. UON
- Meinhof, C. (1932) *Introduction to the Phonology of the Bantu Languages* (English version of *Grundriss Einer Hautlehre der Bantusprachen*, edited by N. J. V. Warmelo). Berlin, D. Reimer/ E. Vohsen, 1932.
- Ngamau, W.N (2004) *A Morpho-syntactic Analysis of Agreement in Gikuyu In The Minimalist Program*. Unpublished MA Dissertation. UON
- Newmeyer, F.J (1998) "On the Supposed 'Counter-functionality' of Universal Grammar: Some Evolutionary Implications" in Hurford, J.R, Studdert-Kennedy, M. & Knight, C. (ed.) *Approaches to the Evolution of Language*. Cambridge: CUP.
- Njagi, JW (1997) *The Kikuyu DP*. Unpublished MA Dissertation UON
- Nyombe, B.V.G(2004) "Null Heads and DP Internal Concord" in *Occasional Papers in Linguistics*. Nairobi. UON. Press

- Osinde, K.N (1988) *A Morphophonology of Ekegusii*. Unpublished MA Dissertation. UON.
- Pollock. S.J (1989) "Verb Movement, Universal Grammar and the Structure of IP" in *Linguistic Inquiry* 20.
- Quirk, & Greenbaum, (1973) *A University Grammar of English*. London: Longman.
- Radford A. (1997) *Syntax A Minimalist Introduction*. Cambridge, Mass.: MIT.
- (1997) *Syntactic Theory and the Structure of English: A. Minimalist Approach*. Cambridge: CUP.
- Radford, A et al (1999) *Linguistics: An Introduction*. Cambridge: CUP.
- Ritter, E (1992) 'Cross- Linguistic Evidence for Number Phrase.' *Canadian Journal of Linguistics*. University of Toronto.
- Shroder, H (2002) *Word Order in Toposa: An Aspect of Multiple Feature Checking*. Unpublished PhD Dissertation. UON.
- Tang J. C. (1988) 'A Note on the DP Analysis of the Chinese Noun Phrase'. Cornell University.
- Tucker, A.N (1957) *A Linguistic Survey of the Northern Bantu Borderland*. London: OUP

- Webelhuth, G (1995) *Government and Binding Theory and the Minimalist Program*.  
Oxford, Cambridge : Blackwell Pub.
- Welmers, W.E (1973) *African Language Structures*. Los Angeles: University of  
California Press.
- Whiteley W.H (1965) *An Introduction to the Gusii*. Nairobi: EALB
- \_\_\_\_\_ (1960) *The Tense system of Gusii* Kampala: East African Institute of  
Social Research.

JOMC - KYATTI MEMORIAL  
LIBRARY

UNIVERSITY OF NAIROBI  
EAST AFRICANA COLLECTION