



International Workshop on Agricultural Innovation Systems in Africa (AISA)

29th - 31st May 2013 | Nairobi, Kenya



Innovation in smallholder farming in Africa: recent advances & recommendations

Proceedings of the International Workshop on Agricultural Innovation Systems in Africa (AISA), 29–31 May 2013, Nairobi, Kenya

Bernard Triomphe, Ann Waters-Bayer, Laurens Klerkx, Marc Schut, Beth Cullen, Geoffrey Kamau and Ewen Le Borgne (Editors)

20 March 2014

Document downloadable at: <http://aisa2013.wikispaces.com/ais+workshop>

ACKNOWLEDGEMENTS

Many people contributed to the preparation, organisation and documentation of the AISA workshop. We particularly want to thank the following people and the programmes and institutions they belong to:

International Scientific and Organising Committee (ISOC)

Adewale Adekunle (FARA), Alan Duncan (ILRI), Wiebke Foerch (CCAFS), Geoffrey Kamau (KARI, JOLISAA–Kenya), Laurens Klerkx (WUR/CoS–SIS), Mary Kamau (Kenyan Ministry of Agriculture), Joseph Mureithi (KARI), Teresiah Ng'ang'a (PROLINNOVA–Kenya), Riikka Rajalahti (World Bank), Luis Rodriguez (FSIFS/AusAID), Bernard Triomphe (CIRAD/JOLISAA) (*ISOC Chair*), Ann Waters-Bayer (PROLINNOVA).

Kenya National Organising Committee (EAFIF–AISA)

Peter Gitika (KENFAP), Geoffrey Kamau (KARI), Righa Makonge (World Neighbors), George Mazuri (USTADI Foundation), Monica Mueni (Kenyan Ministry of Agriculture), Pauline Mugendi (Land o' Lakes), Catherine Mungai (CCAFS), Teresiah Ng'ang'a (PROLINNOVA–Kenya), Rahab Njoroge (IIRR), Aileen Ogolla (Practical Action), Bell Okello (ICRW), Maren Radeny (CCAFS–East Africa) and special thanks to Amos Thiong'o (AgriProFocus/APF) for his immense contributions in organising the Eastern African Farmer Innovation Fair (EAFIF).

AISA facilitation

Ewen Le Borgne and Peter Ballantyne (ILRI) assisted by Ann Waters-Bayer and Bernard Triomphe, members of the International Scientific and Organisational Committee and volunteers drawn from the AISA participants.

WAIA/AISA Secretariat

Ann Gakio, Jane Kiugu, Mary Mwega, Nicholas Jumah, Olivia Mutai, Teresiah Ng'ang'a, Philip Okumu

Sources of funding

We thank the JOLISAA project (EU FP7), CCAFS/PROLINNOVA and AusAID for their financial support. We also thank the many self-sponsored participants, without whom it would not have been possible to hold this workshop.

Correct Citation

Please cite these proceedings as:

Triomphe B, Waters-Bayer A, Klerkx L, Schut M, Cullen B, Kamau G & Le Borgne E (eds). 2014. *Innovation in smallholder farming in Africa: recent advances and recommendations*. Proceedings of the International Workshop on Agricultural Innovation Systems in Africa (AISA), 29–31 May 2013, Nairobi, Kenya. Montpellier: CIRAD. 229 p.

TABLE OF CONTENTS

Acknowledgements	i
Table of contents	ii
Introduction, background and workshop process	1
<i>Objectives and structure of the AISA workshop</i>	2
<i>Who took part in the AISA workshop?</i>	2
<i>The Living Keynote process</i>	3
<i>The AISA workshop and the Eastern African Farmer Innovation Fair</i>	5
<i>Paper structure and review process</i>	6
<i>Content of these proceedings</i>	7
Section 2: Long papers	8
<i>Approach to delivering impact from agricultural research and development: the case of the Sub-Saharan Africa Challenge Program (A. Adekunle, K. Nyakahadzo & S. Siziba)</i>	8
<i>Facilitating institutional change in West Africa: the CoS–SIS experience (S. Adjei-Nsiah, O. Sakyi-Dawson & L. Klerkx)</i>	18
<i>Farmer-managed funds stimulate farmer-led participatory innovation processes (C. Macoloo, G. Kamau, M. Righa, T. Ng’ang’a, A. Waters-Bayer & L. van Veldhuizen)</i>	26
<i>Learning from agricultural research for development in sub-Saharan Africa: development of evidence-based propositions to improve food security outcomes (L. Rodriguez, Y. Maru, D. Walker, R. Ison, W. Wanjura, I. Kershaw & J. Dixon)</i>	37
<i>Multi-stakeholder innovation processes in African smallholder farming: key lessons and policy recommendations from Benin, Kenya and South Africa (B. Triomphe, A. Floquet, A. Waters-Bayer, G. Kamau, J. van den Berg, B. Letty, R. Mongbo, J. Stevens, T. Crane, C. Almekinders, N. Sellamna, S.D. Vodouhê & N. Oudwater)</i>	44
Section 3: Short papers	56
<i>Supporting farmers with funds for innovation: the Ghanaian experience (F. Avorny, J. Lambon, J. Nchor, M. Alebikiya, J.M. Kombiok & B. Alenyorege)</i>	56
<i>Facilitating agricultural innovation: example from Agricultural Innovation Grant Scheme (AIGS) in Papua New Guinea (T. Beshah, A. Mbabu & A. Hall)</i>	60
<i>Reflection on innovation processes in a smallholder goat development project in Mozambique (B. Boogaard, K. Swaans, S. Hendrickx & M. Cosijn)</i>	66
<i>Experiences with aloe domestication and exploitation, Baringo County, Kenya (J. Mulindo Chengole, M. Welimo, R. Belmin, G. Kamau, T. Ng’ang’a & B. Triomphe)</i>	71
<i>From a desired to a despised and later desired tree: the case of prosopis introduction and management in Marigat, Baringo County, Kenya (J. Mulindo Chengole, M. Welimo, R. Belmin, T. Ng’ang’a & G. Kamau)</i>	75
<i>Navigating power dynamics in innovation platforms: lessons from the Blue Nile Basin, Ethiopia (B. Cullen, Z. Lema, J. Tucker, K. Snyder & A. Duncan)</i>	79
<i>ASARECA: Working with national agriculture research systems to build capacity for agricultural innovation systems in Eastern and Central Africa (L. Dusengemungu, O. Ndayitegeye, J. Methu & D. Akishule)</i>	85

<i>No see, no hear, no talk – a three-monkeys fable in the ARD triangle: the agrofishing “hwedo” system of the Ouémé floodplain (Bénin) (A. Floquet, R. Mongbo, G. Vodouhê & F. Houédokoho)</i>	90
<i>Models in innovation studies: a critical reflection based on comparison of four innovation processes in Benin (A. Floquet, S.D. Vodouhê, J. van den Berg, R. Tossou, B. Triomphe & R. Mongbo)</i>	95
<i>How innovation processes unfold along unexpected trajectories: the case of soy in Benin (A. Floquet, G. Vodouhê, A. Michaud, B. Bridier & S.D. Vodouhê)</i>	104
<i>Bringing new ideas into practice: learning from RIU experiments with agricultural innovation (P. Gildemacher, R. Mur & M. Wongtschowski)</i>	109
<i>Innovation research in high-value commodity chains: lessons learnt (H. Høgh Jensen, C. Odhong, R. Onwonga & N. Halberg)</i>	114
<i>Farms of the Future: an innovative approach for strengthening adaptive capacity (A. Jarvis, J. Ramirez-Villegas, V. Nelson, R. Lamboll, N. Nathaniels, M. Radeny, C. Mungai, O. Bonilla-Findji, D. Arango & C. Peterson)</i>	119
<i>Innovation in gadam sorghum production and marketing in Eastern Kenya (J. Kavoi, G. Kamau, R. Kisilu, J. Wafula & T. Ng’ang’a)</i>	125
<i>Experiences from JOLISAA: three cases of multistakeholder innovation processes in South Africa (B. Letty, J. Stevens, G. Rootman, N. Buthelezi, W. Jagiello & B. Triomphe)</i>	128
<i>Agricultural innovation funds at community level in Kenya (C. Macoloo, G. Kamau, M. Righa, T. Ng’ang’a, A. Waters-Bayer & L. van Veldhuizen)</i>	132
<i>Seasonal weather forecasting: integration of indigenous and scientific knowledge (H. Mahoo, W. Mbungu, F. Rwehumbiza, E. Mpetta, I. Yonah, J. Recha, M. Radeny & J. Kinyangi)</i>	137
<i>Broad versus specific agricultural recommendations: implications for research and policy (M. Mkondiwa & R. Coe)</i>	143
<i>Upscaling the orange-fleshed sweetpotato in East and Central Africa (M. McEwan & S. Mayanja)</i>	148
<i>Value-chain development in Uganda: lessons learnt from the Participatory Market Chain Approach (PMCA) (S. Mayanja, B. Akello, D. Horton, D. Kisauzi & D. Magala)</i>	152
<i>Syprobio: Farmer-led innovation platforms to address food security, poverty alleviation and resilience to climate change in West African cotton-growing communities (G. Nicolay, R. Dabire, A. Fliessbach, L. Glin & F. Sissoko)</i>	156
<i>The role of multistakeholder platform processes in promoting innovation in rice-based systems in West Africa (C. Raboanarielina, A. Kaboré, M. Bengaly, F. Dossouhoui & C. Kinha)</i>	162
<i>Enhancing farmers’ organisational and experimentation capacities for soil fertility management in smallholder cropping systems in Vhembe District of Limpopo Province in South Africa (G. Rootman, B. Letty & J. Stevens)</i>	168
<i>Rapid Appraisal of Agricultural Innovation Systems (RAAIS): constraints & opportunities for innovation in controlling parasitic weeds in rainfed rice production in Tanzania (M. Schut, L. Klerkx, J. Rodenburg, J.M. Kayeke, A. van Ast and L. Bastiaans)</i>	172
<i>Action-research platforms in water and agriculture: lessons from three programmes in Africa (J. Tucker, E. Ludi, N. Mason, B. Cullen, Z. Lema, A. Duncan, C. Musvoto & S. Habtu)</i>	177
<i>Lessons learnt about collaborative research from the EU project JOLISAA (JOint Learning in Innovation Systems in African Agriculture) (J. van den Berg, C. Almekinders, A. Floquet, N. Sellamna, S.D. Vodouhê, G. Kamau, B. Letty, J. Stevens, G. Rootman & B. Triomphe)</i>	181

Section 4: Policy implications and policy dialogue 186

Section 5: Seven critical issues for enhancing innovation in smallholder farming – outcome of the living keynote process 189

<i>Introduction</i>	189
<i>1. Innovation drop zones?</i>	190
<i>2. Life under the hedge?"</i>	191
<i>3. Follow the bright lights?</i>	193
<i>4. Surf the wave?</i>	194
<i>5. Brain gain?</i>	195
<i>6. Suspended motion?</i>	197
<i>7. The ripple effect?</i>	199
<i>Conclusions</i>	201

Conclusions and way forward..... 205

<i>Build on innovation “in the social wild”</i>	205
<i>Combine local and external knowledge and ideas to enhance innovative capacity</i>	206
<i>Support unpredictable innovation processes</i>	206
<i>Address the multiple dimensions of innovation</i>	207
<i>How to walk the talk?</i>	207
<i>The way ahead</i>	209

Annexes..... 210

<i>Annex 1: AISA workshop agenda</i>	211
<i>Annex 2: List of AISA workshop participants</i>	212
<i>Annex 3: Expectations of participants</i>	215
<i>Annex 4: Learning from farmer innovators at the Eastern African Farmer Innovation Fair</i>	216
<i>Annex 5: Messages from farmer innovators to the workshop participants</i>	217
<i>Annex 6: Details about hot topics for the Living Keynote</i>	219
<i>Annex 7: Poster marketplace and Open Space session</i>	222
<i>Annex 8: Feedback given by AISA workshop participants on the oral papers</i>	224
<i>Annex 9: Notes from closing evaluation with the AISA workshop participants</i>	229

LIST OF ACRONYMS

ACIAR	Australian Centre for International Agricultural Research
AFAAS	African Forum for Agricultural Advisory Services
AIS	Agricultural innovation systems
AISA	Agricultural Innovation Systems in Africa (workshop)
AR4D	Agricultural Research for Development
ARD	Agricultural Research and Development
ASARECA	Association for Strengthening Agricultural Research in Eastern and Central Africa
AusAID	Australian Agency for International Development
CBO	community-based organisation
CCAFS	Climate Change, Agriculture and Food Security (CGIAR Research Program)
CGIAR	Consultative Group on International Agricultural Research (former name)
CIRAD	Centre for International Cooperation in Agricultural Research for Development
CoP	Community of Practice
CORAF	Conseil ouest et centre africain pour la recherche et le développement agricoles (West and Central African Council for Agricultural Research and Development)
CoS–SIS	Convergence of Sciences: Strengthening Innovation Systems (WUR-led research program in West Africa)
EAFIF	Eastern Africa Farmer Innovation Fair
ECA	East and Central Africa
EU	European Union
FAO	Food and Agriculture Organization of the United Nations
FARA	Forum on Agricultural Research in Africa
FFS	Farmer Field School
FGD	Focus-Group Discussion
FO	farmer organisation
GFAR	Global Forum on Agricultural Research
GIZ / GTZ	GIZ: German Agency for International Cooperation, ex GTZ: Deutsche Gesellschaft für Technische Zusammenarbeit (German Agency for Technical Cooperation)
IAR4D	Integrated Agricultural Research for Development
IK	indigenous knowledge
ILRI	International Livestock Research Institute
IP	Innovation Platform
IS	Innovation Systems
JOLISAA	JOint Learning in Innovation Systems in African Agriculture (EU-funded project)
KARI	Kenya Agricultural Research Institute
LISF	Local Innovation Support Fund
M&E	monitoring and evaluation
MoA	Ministry of Agriculture
NARI	National Agricultural Research Institute
NIS	National Innovation System
NRM	Natural Resource Management

PAR	Participatory Action Research
PIA	Participatory Impact Assessment
PID	Participatory Innovation development
PMCA	Participatory Market Chain Approach
PPP	public-private partnership
PRA	Participatory Rural Appraisal
PROLINNOVA	PROMoting Local INNOVation in ecologically oriented agriculture and NRM
R&D	research and development
R4D	research for development
RIU	Research Into Use (DFID-funded project)
RUFORUM	Regional Universities Forum for Capacity Building in Agriculture
SIMLESA	Sustainable Intensification of Maize and Legumes cropping systems for food security in Eastern and Southern Africa
SSA	sub-Saharan Africa
SSA CP	Sub-Saharan Africa Challenge Program (CGIAR research program)
UAC–FSA	Université d'Abomey-Calavi – Faculté des Sciences Agronomiques (<i>University of Abomey-Calavi, Faculty of Agricultural Sciences</i>)
WAIA	Week on Agricultural Innovation in Africa
WN	World Neighbors
WUR	Wageningen University and Research

INTRODUCTION, BACKGROUND AND WORKSHOP PROCESS

In the wake of a series of recent international events and initiatives focusing on understanding and fostering innovation¹, there is growing awareness and interest in applying and making sense of the Agricultural Innovation Systems (AIS) concepts and perspectives and what they offer for understanding and supporting innovation systems, processes and networks. This has particular relevance for African agriculture as it faces several challenges, such as increasing and intensifying food production in a sustainable way and nourishing its fast-growing population, adapting to the consequences of climate change, and finding its rightful place in an increasingly global and complex international scene.

Several key issues deserve urgent attention from researchers, development practitioners and policymakers involved with African agriculture and innovation:

- What insights and lessons can be gained from recent experiences and initiatives to promote and support agricultural innovation involving smallholders throughout Africa?
- How are AIS concepts and approaches being operationalised in Africa? With what successes and challenges? What added value do they bring compared to other approaches to agricultural research and development (ARD)?
- What are the key implications and recommendations for ways forward in terms of policy, research and practice with regard to supporting agricultural innovation in Africa, and how can these recommendations be implemented concretely in the near future?

Several initiatives and programmes seeking answers to these questions jointly organised a series of events during a Week on Agricultural Innovation in Africa (WAIA) held in Nairobi, Kenya, on 25–31 May 2013, of which the international workshop on *Agricultural Innovation Systems in Africa (AISA)* on 29–31 May was a major part. Another key event during this week, was the Eastern African Farmer Innovation Fair (EAFIF) held on 28–29 May, which was linked to AISA.

Contributions to AISA content and networking came from three major sources. The EU-funded Framework Programme (FP) 7 project JOLISAA² (JOint Learning in Innovation Systems in African Agriculture) brought findings and lessons learnt from case studies about diverse innovation experiences in Benin, Kenya and South Africa. The PROLINNOVA³ (PROmoting Local INNOVAtion in ecologically oriented agriculture and natural resource management) network shared its experience in promoting local innovation and farmer-led participatory research, particularly through community-managed funds. The CGIAR Research Program CCAFS (Climate Change, Agriculture and Food Security), operating currently in Eastern and West Africa and South Asia, presented several papers and took advantage of the events to expand its network of partners throughout Africa and to address its

¹ Among others: the 2006 Innovation Africa Symposium in Uganda; the 2008–13 Convergence of Sciences: Strengthening Innovation Systems (CoS–SIS) programme in Benin, Ghana and Mali; the 2008 World Bank Report on Agriculture; the 2009 IAASTD (International Assessment of Agricultural Knowledge, Science and Technology for Development) report; the 2012 report of the Working Group on agricultural knowledge and innovation systems in the EU Standing Committee on Agricultural Research (SCAR); the 2012 World Bank *Agricultural Innovation Systems Sourcebook*; the 2012 Forum on Agricultural Research in Africa (FARA) report on multi-stakeholder innovation experiences; the *Renewing Innovation Systems in Agriculture and Food* (2012) book that came out of the Innovation & Sustainable Development in Agriculture and Food (ISDA) conference (2010); and various activities underway for the International Year of Family Farming (IYFF) in 2014.

² see www.jolisaa.net for more information

³ PROLINNOVA is a Global Partnership Programme of GFAR (Global Forum on Agricultural Research) in 20 countries in Africa, Asia and Latin America. More details at www.prolinnova.net

“social learning” agenda. The AusAID-funded project Food Systems Innovation for Food Security (FSIFS) offered its lessons about how to better incorporate research into food security initiatives.

Objectives and structure of the AISA workshop

The main objectives of the AISA workshop were to:

- Learn jointly about agricultural innovation processes and systems in Africa
- Identify policy implications and develop policy messages
- Explore perspectives for collaborative action research on smallholder agricultural innovation.

The workshop focused on: a) sharing experiences in trying to understand and strengthen multi-stakeholder innovation processes and the role of smallholders in innovation; and b) identifying and discussing priorities and recommendations for research, practice and policy. Oral presentations were purposefully kept to a minimum. Presentations of lesson-focused posters allowed for extensive and wide-ranging facilitated discussions and intensive social learning among participants.

The workshop was structured around five thematic sessions (see detailed agenda in Annex 1):

1. Opening and participation in the Eastern Africa Farmer Innovation Fair (facilitated dialogue with farmer innovators)
2. Setting the scene for assessing and supporting innovation in Africa and sharing main results and lessons about innovation processes and cases
3. Poster “marketplace”
4. Policy implications and policy-dialogue strategy and messages
5. Finding ways forward.

Details about the AISA workshop process can be found in the workshop report and discussions posted on the workshop wiki (<http://aisa2013.wikispaces.com/ais+workshop>).

Who took part in the AISA workshop?

About 100 participants were purposefully invited to AISA, with a view to allowing intensive interaction, using learning- and output-oriented facilitation methods. Invitees represented a broad range of professional profiles and experiences. They came from the major stakeholder groups concerned with innovation in smallholder agriculture in Africa, including researchers and academics, development practitioners, farmers, and policy- and decision-makers from Africa, Europe and Australia.

Specifically, participants and representatives came from the following programmes and institutions: JOLISAA (a consortium including CIRAD, WUR, ETC Foundation, ICRA, KARI and the Universities of Pretoria and Abomey-Calavi), PROLINNOVA, CCAFS and its associated CGIAR members such as ILRI in particular, AusAID/CSIRO (FSIFS), FARA and its subregional fora, Wageningen University and Research (WUR), the European Commission, GFAR, AFAAS, EU-funded projects such as INSARD (Including Smallholders in Agricultural Research for Development) and SOLINSA (Support of Learning and Innovation Networks for Sustainable Agriculture), Royal Tropical Institute (KIT), the East African Farmer Federation (EAFF), RUFORUM and numerous Kenyan organisations. Most participants covered their own costs. (See Annex 2 for a nominal list of participants).

Several participants also took part in a pre-workshop electronic discussion held in April 2013 to develop and refine evidence-based policy messages that would effectively convey the

importance of strengthening the innovative capacity of smallholders and other stakeholders in ARD to reduce rural poverty and improve food security in Africa⁴.

The Living Keynote process

The AISA workshop organisers decided to go for a process-oriented workshop with a reduced number of papers presented orally to leave room for group work and discussions. Yet there was also a need to address and frame transversal and strategic issues explicitly and visibly. Traditionally, symposiums and congresses do this by making room for key note papers delivered by recognised scholars or professionals. In AISA, we decided for a number of reasons to get away from such traditional keynotes and to experiment with what we called a Living Keynote, which presents four key features:

- (1) It is a collective keynote rather than an individual one, based on “issue owners” collecting, synthesizing and sharing content about specific themes from all workshop sessions and products;
- (2) It is developed iteratively throughout the workshop, rather than prepared before-hand and presented at the beginning;
- (3) It relies on expert knowledge and insights drawn from workshop participants, rather than on academic literature per se;
- (4) The text for the Living Keynote is developed post-workshop.

Concretely, the Living Keynote developed in the following way. Prior to the workshop, the workshop organisers met with the workshop facilitators to brainstorm about key (or “hot”) issues related to the theme of the workshop which, to the best of their knowledge, represented particularly relevant, possibly controversial themes within the international / African innovation systems (IS) community of practice. Selecting such issues was supposed to stir the interest of workshop participants to take part in the facilitated discussions planned for the various workshop sessions. For each of the six issues thus identified, the workshop organisers and facilitators formulated a short, easy-to-remember title and a series of related questions. These six issues were briefly presented and discussed in the plenary at the start of the AISA workshop. During this discussion, workshop participants endorsed the topics identified by the organisers, added specific issues or questions to most of them, and added a seventh hot topic (The ripple effect) (see Box 1).

Box 1: Seven “hot topics” for the Living Keynote

1. ***Innovation drop zones?*** Dealing with interventions “parachuted” into situations without due appreciation of and embedding into local realities
2. ***Life under the hedge?*** Missing endogenous innovations under the radar of innovation “experts”
3. ***Follow the bright lights?*** Fitting current enthusiasms, e.g. for market-driven innovation, to all circumstances
4. ***Surf the wave?*** Balancing more directed and output-driven innovation projects with more opportunistic outcome-oriented innovation processes
5. ***Brain gain?*** Strengthening capacities to innovate and to facilitate innovation processes
6. ***Suspended motion?*** Monitoring, evaluating, adjusting, learning and reflecting on innovation results, outcomes and impacts
7. ***The ripple effect?*** Scaling innovation up and out ...

(See detailed issues related to each one of these seven topics in Annex 6)

⁴ Waters-Bayer A, Oudwater N & Meijboom M. 2013. Report on second electronic discussion (ED-2), 22–30 April 2013. Leusden: ETC Foundation / JOLISAA. Available at www.jolisaa.net

Other issues raised by participants after the introduction to the Living Keynote are listed in Box 2.

Box 2: Other questions raised by AISA workshop participants when the Living Keynote was presented

- How do we use an innovation systems lens to understand the world?
- What are incentives for innovation?
- What about the educational background of those involved in innovation?
- Free public goods and intellectual property?
- How to make innovation more visible for society?
- How to achieve impact at scale (hard and soft parts)?
- How to institutionalise innovation?
- How are our organisations facilitating innovation to challenge ourselves and our own innovation?
- How to coordinate efforts?
- How to influence policy from local level up?
- How can policy become enabling and how to convince policymakers?
- Gender: a cross-cutting issue to integrate in all discussions

During the course of the workshop, seven self-selected participants⁵ (one per hot topic) followed their respective topic, with the help of Peter Ballantyne (ILRI), one of the workshop facilitators. Their tasks were : i) identifying the various insights and suggestions related to their respective topic that were raised in workshop sessions in which they participated; and ii) feeding a Living Keynote Wall (see Figure 1) by pinning and clustering cards capturing points related to their topic. The Living Keynote Wall, situated at the back of the main workshop hall and accessible to all workshop participants, was illustrated with drawings made by another volunteer among the participants (Birgit Boogaard). They then developed synthetic synthesised the content related to their respective topics s, and presented the results on the final day of the workshop for comments and discussion.

This collective undertaking enabled the synthesis of perspectives and experiences which was much broader than the reflections of one individual. It also provided AISA participants – many of them practitioners rather than academics – a better opportunity to make their voices heard.

After the workshop, the seven topic owners wrote a short text corresponding to their presentations, which was eventually integrated into one paper by the proceeding editors. The Living Keynote also builds on discussions around the papers and posters presented in parallel sessions and in the plenary.

The “final” Living Keynote – the outcome of this collective brainstorming on critical issues for strengthening agricultural innovation in Africa – is presented in [Section 5](#) of these proceedings, after the conventional papers.

⁵ Brigid Letty (INR), Marc Schut (WUR), Luis Rodriguez (CSIRO), Laurens Klerkx (WUR), Silvia Sarapura (World Fish), Guy Faure (CIRAD) and Mariana Wongtschowski (KIT)

In the evening session, one farmer from each of the four country groups addressed the AISA participants and conveyed messages to be taken into account during the rest of the workshop. The farmers stressed that the scientists should come to the field to see what farmers are doing and should take sufficient time to understand innovation processes in smallholder farming. They invited scientists to work together with farmers to improve their innovations (see Annex 5).

At the closing ceremony of the fair, awards were presented to top innovations (and innovators), these were judged based on their originality, technical viability, environmental sustainability, social acceptance, relevance for smallholdings and suitability to be upscaled. The four-person team of judges was composed of agricultural scientists and donor representatives.

More details about learning from the EAFIF can be found in Annex 4 and a full report on the fair can be found in the WAIA wikispace (<http://aisa2013.wikispaces.com/farmer+fair>).

Paper structure and review process

The following terms of reference applied both to long (8–10 pages) and short (4–5 pages) papers. Long papers were presented orally, while short papers were presented in poster form.

- *Introduction*: What is the paper all about? What are the strategic issues and the key concepts the paper is dealing with?
- *Materials and methods*: How, when and where was the work conducted? (brief & factual)
- *Main results*: Focus on a few key topics of strategic interest to AISA. Authors were encouraged to address one or several of the following key issues in their papers
 - The role of the “enabling” (or not) environment (including institutional aspects)
 - Capacity building and education for innovation (for different stakeholders, in different forms)
 - Multistakeholder partnerships: nature, functioning (conflicts, negotiation, asymmetries), brokering, platforms etc.
 - Dynamics of scaling up / working across scales (from local to national or international)
 - Dynamics and timeframe for innovation (including uncertainties, sustainability, relationship with project timeframes and boundaries)
 - Smallholder contribution to innovation
 - Various dimensions of innovation and how they interact with each other (social, institutional, technical)
 - The role of public research and development in innovation
 - The role of private research and development in innovation.
- *Key challenges met*: What were the main challenges related to the key results and/or to the approach taken in the work (important to avoid the "success story" bias.)?
- *Key lessons and recommendations for research / policy / practice*: Relate these to the key results but formulate them as generically and clearly as possible, so that they may have wider relevance for supporting multistakeholder innovation processes and systems.
- *Conclusions*: Keep these concise and incisive.
- *Main references*.

As usual, authors followed these guidelines with some flexibility. Each paper was lightly reviewed by at least two persons within the editorial team for the proceedings. The paper was then sent back to the authors for revision and finalisation, and edited for format and English before inclusion in these proceedings.

Content of these proceedings

After this introduction, these proceedings are organised around **four main sections**..

- *Section 2* present five “long” papers (about 8–10 pages each) based on the oral presentations made during parallel sessions at the AISA workshop, which present results and perspectives of five programmes and initiatives, including FARA, COS-SIS, PROLINNOVA, AUSAid, PROLINNOVA and JOLISAA⁶.
- *Section 3* includes 26 short papers (about 4–5 pages each) based on the posters that were presented during the marketplace session.
- *Section 4* brings highlights from the discussions during the workshop about policy implications of the lessons drawn from working in AIS and how policy messages could be brought across to different types of stakeholders and decision-makers.
- *Section 5* brings the results of the Living Keynote process, i.e. the collective brainstorming on seven key issues for strengthening innovation in smallholder farming in Africa.

The *concluding section* summarises the key lessons learnt about AIS in African smallholder farming and offers specific suggestions for the way forward.

The **annexes** for their part include the workshop agenda (*Annex 1*), the list of participants (*Annex 2*), participants’ initial expectations for the workshop (*Annex 3*), the interaction between the workshop participants and the farmer innovators attending the Eastern African Farmer Innovation Fair (*Annex 4*), and a synthesis of the messages that the farmer innovators gave to the AISA workshop participants (*Annex 5*). *Annex 6* provides details about the 7 hot topics which structured the living keynote. *Annex 7* gives a brief description of the process of the marketplace for posters and other information and the Open Space topics. The feedback that the participants gave on the six oral presentations (see Section 2) is given in *Annex 8*; it is advisable to read the papers in Section 2 and even 3 before reading this annex, so as to be able to understand the context in which the discussion points were raised. Finally, the notes on the evaluation made by the workshop participants at the end of the event are given in *Annex 9*.

Note: *Besides these proceedings, details about the workshop process, and electronic versions of the posters and of the flipcharts written up during the Open Space discussions on topics defined by workshop participants can be found on the AISA workshop wiki (<http://aisa2013.wikispaces.com/ais+workshop>)*

⁶ A sixth parallel session was actually held during AISA to share the results on the ILRI/CPWF “writeshop” on innovation platforms. The outputs of the writeshop are available in the form of “practice briefs” under <http://cgspace.cgiar.org/handle/10568/33667/browse?value=Policy+Brief&type=output>.

SECTION 2: LONG PAPERS

Approach to delivering impact from agricultural research and development: the case of the Sub-Saharan Africa Challenge Program

Adewale A. Adekunle^{1*}, Kefasi Nyakahadzo² and Shephard Siziba³

¹Forum for Agricultural Research in Africa (FARA), Accra, Ghana

²Centre for Applied Social Sciences, University of Zimbabwe, Harare, Zimbabwe

³Agricultural Economics, University of Zimbabwe, Harare, Zimbabwe

* Corresponding author. Email: aadekunle@fara-africa.org

Abstract

Effective agricultural transformation will only be rooted in an approach that generates returns for the smallholder farmers and other stakeholders in the sector in a sustainable manner. Such an approach needs to regard agriculture as a system and use a best-partnership arrangement that engages all the necessary stakeholders along the different commodities and system value chains or value webs. This thinking led to the development of the Sub-Saharan Africa Challenge Program (SSA CP) in 2004. The aim of the SSA CP is to facilitate a substantial increase in the impact of agricultural research and development (ARD) for improved rural livelihood, increased food security and sustainable natural resource management throughout sub-Saharan Africa. To achieve this objective, the SSA CP proposed a new approach to conduct agricultural research, named Integrated Agricultural Research for Development (IAR4D). This approach entails a multisectoral orientation to problem diagnosis and draws on integrated approaches using “hard” and “soft” sciences to provide solutions, while making the most of the available resources. This concept is premised on an “innovation systems” approach and requires systemic interaction among all stakeholders around a specific commodity or production system. This paper discusses thinking around this concept and highlights the challenges and benefits of adopting IAR4D in sub-Saharan Africa.

Keywords: *integrated agricultural research for development, innovation systems, innovation platforms, agricultural transformation*

Introduction

The Sub-Saharan Africa Challenge Program (SSA CP) was initiated in 2004 following the perceived failures of conventional agricultural research and development (ARD) to improve agricultural productivity in Africa. It was noted that, besides inadequate funding, the main impediment to the contribution of African agricultural research to development impact was in the way the research was organised and conducted (SSA CP 2008). Under the conventional ARD paradigm, research, technology transfer and technology use have been treated as independent activities whereby research derived knowledge consisting of large prescriptive technology packages flows linearly from researchers to farmers through extension agents (SSA CP 2008).

In fact, the Interacademy Council (2004) attributes the lack of agricultural productivity in sub-Saharan Africa to failure in putting useful research into use. Triomphe *et al* (2009) note that numerous cases of academic on-station and non-participatory research failed to bring desired impacts such as changes in policy and practice. Moriarty (2007) also notes that the implementers (NGOs, donors, governments) often did not take forward any efforts to involve

farmers through action research, farmer learning and other interactive methodologies. Even where they did, the household income of smallholder farmers did not improve either because of poor linkages to markets or because of lack of complementary efforts. Furthermore, many of the local innovations could not be upscaled largely because the institutions that could take up this task were not well developed.

While the adoption of action research and other participatory approaches made research activities and agendas more relevant and practical, it has focused on the level of the individual or the community (Moriarty *et al* 2005). Therefore, other stakeholders (such as agrodealers, agroprocessors and local representatives of government departments) that were intended to support these smallholder farmers were sidelined; in some cases, they were even seen as “part of the problem”. This is counterproductive because all these players have specific roles and are essential links in the chain necessary for improving agricultural productivity. Moriarty *et al* (2005) thus conclude that, without inclusive participation of all stakeholders involved in an agricultural system, the founding research agenda may be incomplete or misdirected and ultimately the impact of an innovation can become limited and unsustainable because the institutions vital to scaling up have not been represented in the research process. According to Hall (2005), embedding research in a system of innovation recognises that it is not just knowledge inputs that are missing; also the institutions and processes necessary to make knowledge available and to enable its use are missing. Integrated Agricultural Research for Development (IAR4D) proposed by the Forum for Agricultural Research in Africa (FARA) is premised on this understanding.

Evidence presented in this paper is based on fieldwork carried out between 2008 and 2012. One of the authors was involved in the SSA CP as monitoring and evaluation postdoctoral fellow, specifically looking at the establishment and field-level processes of innovation platforms. The IAR4D was implemented in three Pilot Learning Sites (PLSs; Figure 1). These are the Kano-Katsina-Maradi PLS in Niger and Nigeria; the Lake Kivu PLS, which included Rwanda, Uganda and Democratic Republic of Congo; and the Zimbabwe-Mozambique-Malawi PLS. The SSA CP adopted an experimental approach to test whether IAR4D works or not. In this paper, we will also select a few indicators to show that IAR4D provides more benefits to end-users. The paper is divided into three sections. The first section discusses efforts by the SSA CP to change institutional arrangements in ARD. The theoretical and empirical justification is then discussed in the second section of the paper. The final section discusses some challenges and important imperatives for the success of such institutional innovations to improve agricultural productivity in Africa south of the Sahara.

Research and development practices in sub-Saharan Africa

Research and development in sub-Saharan Africa is characterised by serious power differentials between smallholder farmers and other stakeholder along the commodity value chain. The power differentials may emanate from information and knowledge, economic strength and resources, and political power, which reduce farmers’ role in research.

In many instances, efforts to increase productivity were difficult to replicate in other areas. Moriarty *et al* (2005) cite depressing familiar examples where such efforts were used. These include: subsidising inputs for farmers; paying for people’s participation; subsidising the use of highly trained facilitators to overcome bottlenecks; creating parallel structures to bypass “failing” government; working with highly motivated project teams that cannot be replicated; unrealistic levels of resources for Participatory Rural Appraisal – vehicles, fuel for vehicles, per diems for government staff and so on.

Technology dissemination procedures are characterised by a process where researchers, nongovernmental organisations (NGOs), donors and other implementing agents carry out development-oriented research, then produce a report and some academic papers, and finally convene a dissemination workshop. This approach fails to bring any impact, as the

dissemination process does not consolidate lessons learnt. The practice also does not give rise to true sharing of results and the development of national- or district-level ownership. Uptake and upscaling is left to ill-defined processes of “dissemination” and “advocacy”. The research approach fails to create room for capacity building within the relevant regulatory and implementing institutions such as local government, the private sector, NGOs and extension services (Moriarty *et al* 2005). In most cases, the staff within these agencies would not have been equipped with the skills to take the innovations for upscaling after the project.

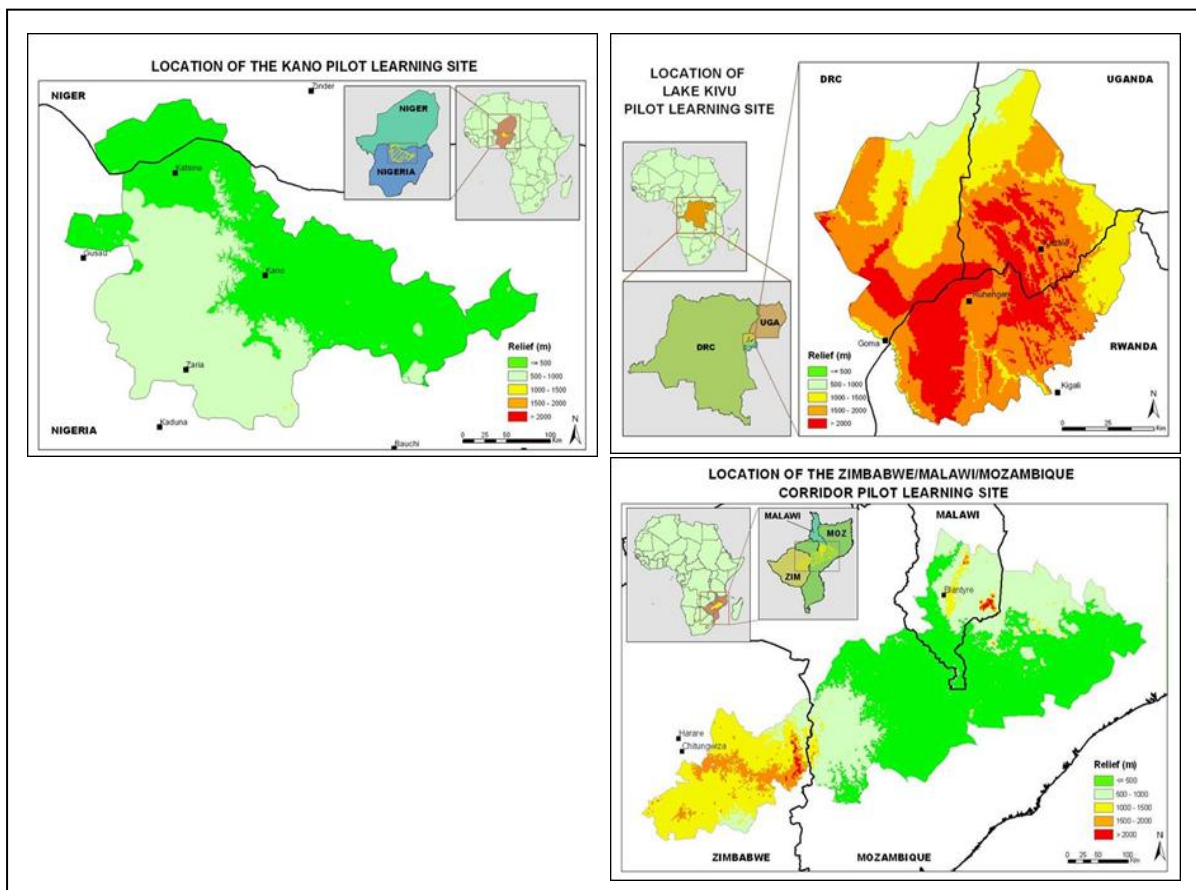

Figure 1: Location of pilot learning sites

Agriculture development in sub-Saharan Africa is characterised by sector fragmentation with a number of subsectors and each subsector unilaterally promoting agricultural development among smallholder farmers. For example, suppliers, agroprocessors, irrigation development, natural resource management and microfinancing all have separate programmes designed to develop smallholder agriculture. Such sector fragmentation has failed to bring synergies between and among the various stakeholders.

Institutional reforms under the SSA CP

In this section, we discuss the goal, philosophy, approaches and strategies of integrated agricultural research and development

Mission and goal of the SSA CP

The mission of the SSA CP is to add value and enhance the impact of ongoing agricultural research for development in SSA by transforming the way sectors and institutions at all levels approach agricultural research. The overall goal of the Programme is to contribute to improved rural livelihoods, increased food security and sustainable natural resource management throughout SSA, by adapting and promoting appropriate agricultural research for development approaches. The Programme seeks to contribute to meeting the poverty and

hunger targets of the Millennium Development Goals (MDGs) and New Partnership for Africa's Development (NEPAD) goals as set out in the Comprehensive Africa Development Programme (CAADP). Initially, the SSA CP focused on a scientifically rigorous validation of the IAR4D concept.

The philosophy of the SSA CP

The SSA CP adopted an Integrated Agricultural Research for Development (IAR4D) concept. The concept is designed to foster social interaction and learning by embedding agricultural research within a larger system of innovation, whereby knowledge from numerous sources is integrated and effectively put into use. The IAR4D concept uses innovation platforms (IPs) to embed agricultural research and/or development organisations in a network to undertake multidisciplinary and participatory research and other action-oriented activities. The establishment of IPs is in response to the recognition that new technologies and processes are brought into use not just by the activities of researchers, but through the activities of a number of widely different actors and organisations that have the competence and also the incentive to improve agricultural productivity. The IP diagnoses problems of common interest, exploring opportunities and investigating solutions.

In an IP, there should be direct and continuous interaction, communication and knowledge sharing among the IP actors (Figure 2). This facilitates quick and continuous feedback from end-users (farmers) at all stages of research for development. It also ensures the timely integration of new knowledge into the innovation process using experiential learning, monitoring and evaluation and the continual feedback. The new institutional reforms are expected to overcome the shortcomings of traditional approaches and generate greater impact from agricultural research for development (AR4D) leading to improved rural livelihoods, increased food security and sustainable natural resource management throughout SSA.

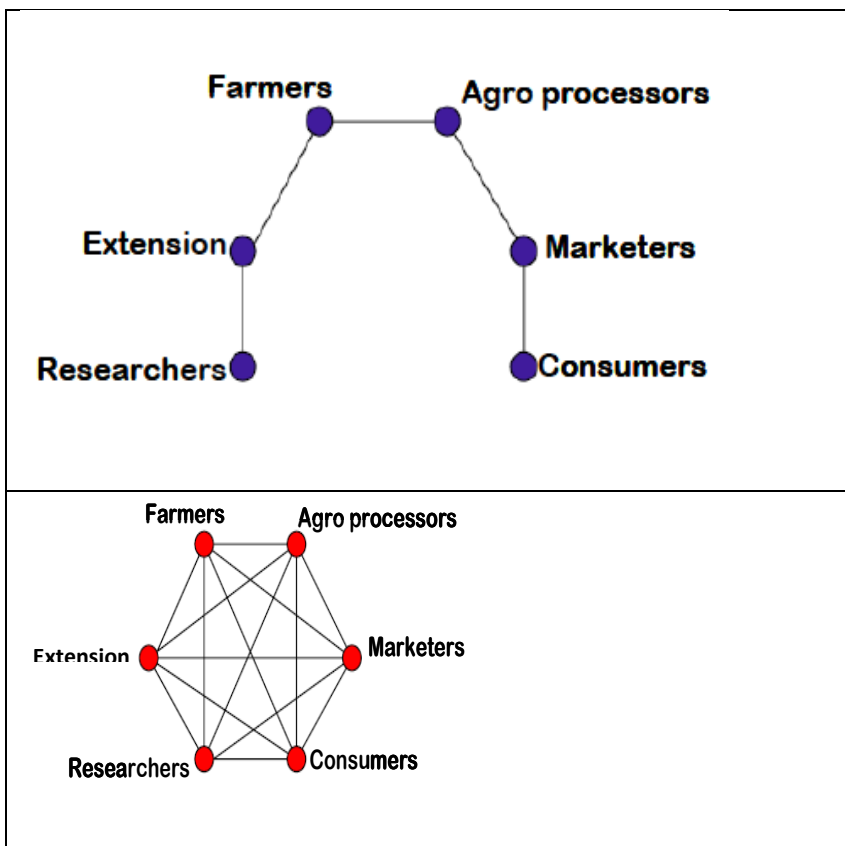

Figure 2: A contrast between ARD and IAR4D. *above*, ARD actors in a linear configuration; *below*, IAR4D actors in network configuration (Source: SSA CP 2000)

IPs in a given locality should be part of a multiple nested subsystem of IPs (Figure 3). Government agencies at national level are also the ones operating at intermediate level. This ensures that activities at intermediate levels are compatible with what national government does and activities at intermediate level can easily be communicated at national level. Effective communication between platforms at different levels is very crucial. In a case where several platforms are involved, information flows in all directions are crucial.

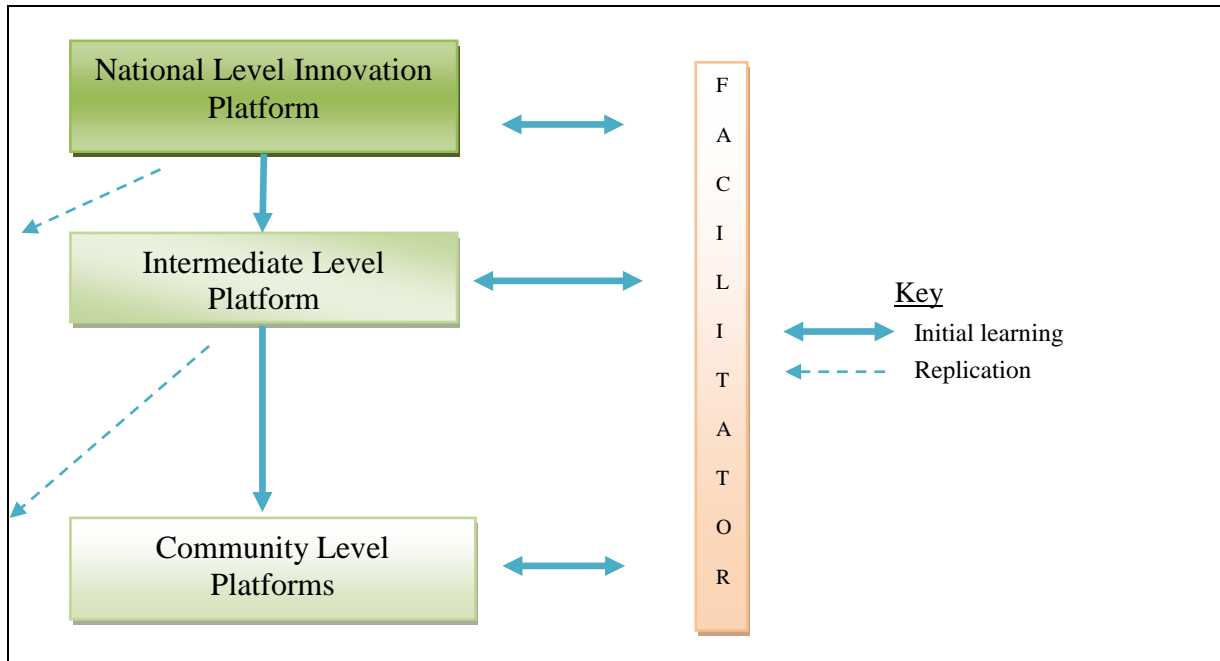

Figure 3: Different levels of innovation platforms

The national-level IP's major responsibility is to set the legal framework for the operation of the other platforms below it. It determines what power and authority officers can exercise and directs the activities and rules at intermediate level. The intermediate-level platform determines the operational-level activities and rules of engaging various actors. It also determines the criteria for selecting participating communities and farmers.

Participants at this level are drawn from agencies, NGOs, donors and government agencies working in the area. Implementation is undertaken at community level. The IP at this level will deal with issues such as what activities and practices need to be undertaken.

SSA CP research strategy and priorities

The SSA CP aims to achieve its stated goal by focusing on the interactions among the following four components (Figure 4): i) technologies for sustainably intensifying smallholder farming systems; ii) smallholder production systems that are compatible with sound natural resource management; iii) accessibility and efficiency of markets for smallholder and pastoral products; and iv) formulation and adoption of policies and institutional arrangements that foster innovation to improve livelihoods of smallholder farmers and pastoralists. The niche and primary contribution of the SSA CP is to increase understanding about interactions among the four components and use this knowledge to overcome constraints associated with the interface issues.

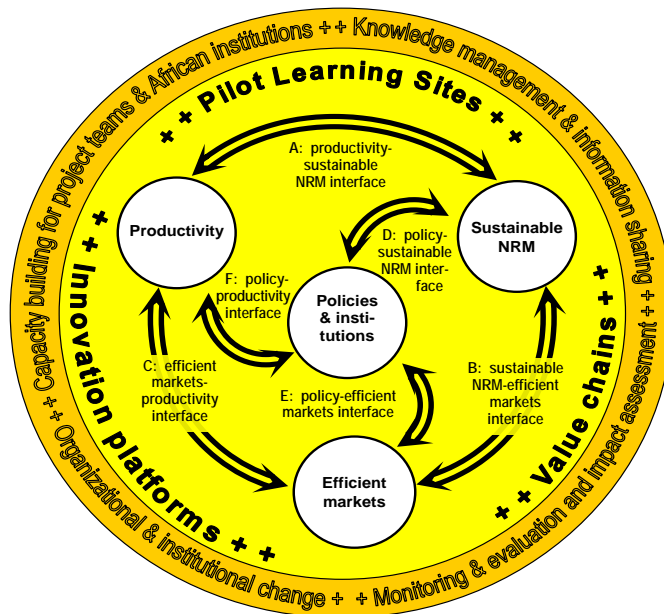

Figure 4: The research components, interfaces and support functions of the SSA CP

Participatory action research process

Stakeholders in an innovation platform are brought together by a shared common desire to improve agricultural productivity for a common good. They then share common approaches, strategies and tools on how to achieve mutually agreed goals through joint planning and implementation of agreed activities. Actors in the IP adopted participatory action research. The approach situates research within a set of relationships to allow the generated knowledge to be put into effective use through interactive learning. The process uses a spiral of cycles of planning, acting (implementing plans), reflecting and then replanning, further implementation and reflecting. An IP identifies and defines the problem. The IP then considers alternative courses of action to deal with the problem and enable smallholders to increase their surplus. The multistakeholder partnership then studies the consequences of the course of action. At this stage, they seek answers to questions such as: What were the outcomes of the action, for example, how did yield change as a result of using a given technology or a combination of several technologies? What are the economic and social benefits of a given technology compared to the farmers' yields obtained? They then reassess their objectives in the light of observations and reformulate plans for the next season. This interactive process is repeated so that lessons from previous activities are applied in future activities.

Theoretical and empirical justification of IAR4D

Coase (1960) argues that, where transaction costs are zero, efficient solutions that would produce the highest aggregate income could be achieved. This theory is based on the assumption that actors have information necessary to evaluate correctly the alternatives and consequently make a choice that achieves desired ends. According to Williamson (2000), transaction costs are a major impediment towards the attainment of mutually desirable outcomes. Transaction costs include frequency, specificity, uncertainty, limited rationality and opportunistic behaviour. The process, if well managed, could reduce transaction costs leading to mutually advantageous terms of trade among all stakeholders involved.

The stakeholders involved have complementary capabilities which, when combined, will allow the new knowledge created in the innovation process to be brought to scale (Hall 2005). As stated earlier, players in an IP include public-sector (e.g. line ministries, research institutes), private-sector (e.g. agroprocessors, traders and financial services) and civil-society

(e.g. NGOs, unions, advocacy) organisations and the beneficiary communities. All these stakeholders depend on one another for realisation of their objectives, thus removing opportunistic behaviour. It implies shared ownership of the research agenda and programme of activities and an overall sense of joint responsibility for outcomes (Ashby 2009). Situating research in a wide set of relationships places it closer to all organisations that need to respond to changing production conditions, market fluctuations and trends, and changing policy and regulatory environments (Moriarity *et al* 2005). This can reduce the cost of acquiring necessary information required for planning.

Morales (2006) views IPs as institutions that can reduce transaction costs and risks that characterise ARD. They can in turn provide good incentives for the participation of service providers and farmers in improving agricultural productivity. If properly constituted, IPs can positively affect or govern the way that agents cooperate or compete. For example, IPs can help in reducing economic coordination risks, which Dorward and Kydd (2004) in Morales define as “the risk of failure of an investment due to the absence of complementary investments by other players at different stages in the supply chain”. In other words, it can lead to the generation of a national public good.

Morales (2006) argues that repeated transactions lead to frequent exchange among economic agents so that, with each transaction, they know each other better than they did for the first transaction. The increased interaction and establishment of a relationship may build trust, depending on how successful the transactions have been and, as a result, imperfect information about the other party decreases (*ibid*). Frequent successful exchanges, therefore, lead to decreased transaction costs since trust among economic agents increases and creates disincentives for opportunistic behaviour.

Applications of lessons learnt in the previous transactions over time may cause an improvement in the exchange process in future transactions (Morales 2005). Similarly, economic agents also formulate incentives to comply with transactions in order to gain future business; this action may lead to a lower propensity for opportunistic behaviour among economic agents and may also reduce uncertainty related to future transactions (*ibid*).

Benefits and challenges of IAR4D

Benefits

IPs at all levels involve stakeholders that pursue different economic and social agendas. IAR4D is supposed to create win-win situations for all stakeholders within the IP. It is important to have an alignment of the IP activities with private sector’s profit motive. Below are selected cases of such scenarios.

A case of mamera, a local beverage now produced in Uganda, shows how IAR4D can benefit all players along the value chain. The University of Makerere improved the taste and rebranded the local mamera. An entrepreneur who is also a member of the platform took up the new brand and is now producing mamera for urban consumers. He buys sorghum from smallholder farmers. The demand for more sorghum also means an increase in demand for inputs. Agrodealers in the area have also witnessed an increase in sales of farming inputs. Stanbic provided loans to smallholder farmers in order to access inputs. Given that there is a ready market for sorghum, the loan repayment has also improved significantly.

In Malawi, vegetable growers were struggling to find a market for their produce. When a local boarding school and a hospital joined the innovation platform, they started to buy vegetables from a collective of farmers. Smallholder farmers increased their production of vegetables as demand for fresh vegetables went up and transaction costs of finding buyers were reduced. Also the school and the hospital could readily buy vegetables from a collective as opposed to many small buyers each selling very small quantities. A local agrodealer who is also a member of the platform developed input packs with all the required seeds, fertilisers

and agrochemicals required for the production of selected vegetables. The agrodealer would loan out the packs to farmers who would repay after selling their vegetables. In this case, the agrodealer was assured to get his money either from the school or the hospital before they make a final payment to the farmers. Impact studies have shown that IAR4D has improved smallholder farmers' income (Nyikahadzoi *et al* 2013), access to markets (Siziba *et al* 2013) and adoption of certain technologies (Nyikahadzoi *et al* 2012) in Southern Africa.

Challenges

We also learnt that it is difficult to create an incentive structure that fosters stakeholders with varying values systems to drive the process of IAR4D. Different stakeholders would require different incentive structures to fully subscribe to the IP and its activities. Private-sector players are typically more conscious or critical of nominally unproductive activities and thus often became difficult to engage with. Public-sector and civil-society organisations tend to be more readily available to attend stakeholder meetings. However, it is important to create incentives that ensure organisational stakeholders are represented by (the same) dynamic individuals, with decision-making potential and/or access to key decision-makers. At community level, marginalised civil-society groups such as ethnic minorities, poor women who may feel intimidated by the scale and activities of certain gatherings, and proactive initiatives should be taken on board to ensure their representation and fullest participation.

The stakeholders in IPs have different philosophies and approaches of working towards achieving their organisational visions. As IAR4D is a new concept, IP actors tended to pursue their own perceptions and understanding of how to implement the concept. We also discovered that there are challenges of creating a "joint reality" after bringing together these multiple realities. Although we were very anxious to improve productivity and incomes of stakeholders on the platform, we also noted that it is important to deconstruct the multiple understandings and approaches through dialogue, joint analysis and reflective learning. The process cannot be cut short as most lessons are learnt by doing and sometimes through error. People have to try something, adapt it themselves until it works and then continue to adapt as the world changes. In an IP, the learning is done throughout the process, not at the end.

Making innovation platforms work

For the IP to promote research for development, it is important to deconstruct researchers' belief systems and establish a culture of equality. In such a scenario, researchers should not view farmers as people who should receive and adopt technologies, but rather as actors with something valuable to offer that is complementary to their own scientific knowledge. Researchers and other technocrats should accept that it is not the technological innovation that is important, but the institutional innovation that guides the process of change, uptake and upscaling (Killough 2009). It is also crucial to accept that time is required to create local knowledge on how to use new innovations. According to Waters-Bayer *et al* (2009), it is important to create an enabling environment that can facilitate shared learning among different stakeholders that will, in time, increase the impact of interventions. In this context, it therefore means that rather than measuring success according to how many farmers adopted a particular technology, the focus should be on enhancing a continuous process of interactions.

The size of the IP at all levels should be small enough to allow face-to-face interaction and facilitate effective communication among members. Theories of social networks argue that small member groups promote interdependence and commitment towards accomplishment of a common vision (Ostrom 1995). There is no magic number that is associated with the best size of the IP. Efficient size may vary with the task and the amount of follow-up action wanted. However, as size of the IP increases, problems of group management also increase.

The facilitator will have less influence and the group members feel less satisfied because of lack of time to express themselves. This can lead to factionalism.

An initially small group of actors with representatives from as few as a dozen stakeholders can be ideal to start an IP. The membership of the IP should be allowed to grow over time; both as new stakeholders are contacted and as the activities of the IP are broadened. The idea is to keep the IP as small as possible to reduce transaction costs associated with a large membership. Where the number of participants becomes too big, the group can be broken down into task forces or subnetworks.

Capacity building

Embedding research in a system of innovation requires new ways of doing research and disseminating results. This calls for capacity development among stakeholders designed to create new linkages that support interactions and learning and new institutions that foster new forms and patterns of behaviour, routines, norms and new roles. Creation of new patterns of interaction and learning is a long-term process through incremental change in habits and practices to better achieve a common understanding and allow for the adoption of an incremental process of reflection and learning.

Capacity building should be designed to create new organisational culture, elements of which should include: openness to partnership, consensus and dialogue; a willingness to respect the views of stakeholders; a willingness to participate in knowledge sharing and exchange; a recognition that ways of working and institutional arrangements are inherently experimental with the scope for continuous improvement; the recognition that innovation can involve more than technology transfer; participatory development; and interactive learning. Actors at intermediate level of the IP should learn how they best fulfil their community support role.

Conclusions

IAR4D has the potential of improving agricultural productivity, aligning agricultural policies with practice and also maintaining healthy natural resources in sub-Saharan Africa. However, its success depends on the energy, vision and readiness to embrace a culture of partnership of the stakeholders in the platform. Ideally, the champions of IAR4D should be people for whom the work of the IP is part of their everyday job and for whom the success of the IP will also bring personal and organisational success. A few years of experimenting with the concept has shown that, if properly constituted and managed, IAR4D can deliver more benefits to smallholder farmers in terms of improved adoption, increased access to lucrative markets, improved income levels and increased productivity. It is also important to note that sustainability of the multi-stakeholder partnerships also depends on the how stakeholders involved find the arrangement to be beneficial to them. All stakeholders are likely to continue participating in the IP activities if they feel that the research and processes are addressing factors and issues that constrain agricultural productivity.

References

- Ashby JA. 2009. Fostering farmer first methodological innovation: organisational learning and change in international agricultural research. In: Scoones I & Thompson J (eds), *Farmer first revisited: innovation for agricultural research and development* (Rugby: Practical Action Publishing), pp39–48.
- Coase RH. 1960. The problem of social costs. *Journal of Law and Economics* 3 (October): 1–44.
- Hall A. 2005. Embedding agricultural research in a system of innovation. CGIAR Science Forum “Strengthening research-for-development capacities”.
- IAC (Inter-Academy Council). 2004. Realising the promise and potential of agriculture: science and technology strategies for improving agricultural productivity and food security in Africa.

- Amsterdam: IAC (www.interacademycouncil.net)
- Killough S. 2009. Partnership for action research. In: Scoones I & Thompson J (eds), *Farmer first revisited: innovation for agricultural research and development* (Rugby: Practical Action Publishing), pp153–157.
- Morales EG. 2006. Institutional arrangements to improve the responsiveness of agricultural innovation systems to the needs of the poor: an investigation of participatory monitoring and evaluation in Bolivia. PhD thesis, University of London.
- Moriarty P. 2007. A brief introduction to action research concepts and practice. IRC Learning Alliance Briefing Note 4. Delft: International Water and Sanitation Centre (IRC) (draft).
- Moriarty P, Fonseca C, Smits S & Schouten T. 2005. *Learning alliances for scaling up innovative approaches in the water and sanitation sector*. Delft: International Water and Sanitation Centre.
- Nyikahadzoi K, Siziba S, Nelson N, Diagne A & Adegunle A. 2012. Impact of integrated agricultural research for development on adoption of soil fertility management technologies among smallholder farmers of Southern Africa. *Journal of Agricultural Extension and Rural Development* 4 (19): 512–521.
- Nyikahadzoi K, Siziba S, Nelson N, Zamasiya B and Adegunle A. 2013. The impact of agricultural research for development on collective marketing among smallholder farmers of Southern Africa. *Asian Journal of Agriculture and Rural Development* 3 (5): 321–336.
- Ostrom E. 1995. Institutional analysis, design principles and threats to sustainable community governance and management of commons. In: Berge E & Stenseth CN (eds), *Law and governance of renewable resources*. Report No. 46. Trondheim: Department of Science and Technology.
- Siziba S, Nyikahadzoi K, Nyemeck J, Diagne A, Adegunle A & Fantunbi O. 2013. Estimating the impact of innovation systems on maize yields: the case of IAR4D in Southern Africa. *Agrekon* 52 (3): 83–100.
- Sub-Saharan Africa Challenge Program (SSA CP). 2008. Medium-Term Plan 2009–2010. Accra: Forum for Agricultural Research in Africa.
- Triomphe B, Hocde H & Faure G. 2009. Research involving multi-stakeholder partnerships. In: Scoones I & Thompson J (eds), *Farmer first revisited: innovation for agricultural research and development* (Rugby: Practical Action Publishing), pp161–162.
- Waters-Bayer A, Wettasinha C & van Veldhuizen L. 2009. Building partnerships to promote local innovation processes. In: Scoones I & Thompson J (eds), *Farmer first revisited: innovation for agricultural research and development* (Rugby: Practical Action Publishing), pp144–145.
- Williamson OE. 2000. The new institutional economics: taking stock, looking ahead. *Journal of Economic Literature* 38: 595–613.

Facilitating institutional change in West Africa: the CoS–SIS experience

Samuel Adjei-Nsiah¹, Owuraku Sakyi-Dawson² and Laurens Klerkx³

¹ *Forest and Horticultural Crops Research Centre, Kade, Institute of Agricultural Research, College of Agriculture and Consumer Sciences, University of Ghana, Legon, Ghana*

² *Department of Agricultural Extension, School of Agriculture, College of Agriculture and Consumer Sciences University of Ghana, Legon, Ghana*

³ *Knowledge, Technology and Innovation Group, Wageningen University, The Netherlands*

* Corresponding author. Email: y_nsiah@yahoo.co.uk

Abstract

The Convergence of Sciences–Strengthening Innovation Systems (CoS–SIS) programme is based on the premise that the livelihood of the African smallholder farmer is constrained by the existence and/or performance of formal and informal institutions that are not conducive to small-farm development. CoS–SIS employs nine platforms in Ghana, Benin and Mali – “Concertation and Innovation Groups” (CIGs) – that aim to facilitate institutional change above the farm level (e.g. rules and regulations, bylaws, policies, interaction patterns in the value chain), in order to create a conducive environment for farm-level innovation, which is also often linked to technical innovation. Issues that should be taken into consideration when implementing an innovation platform include: conditions external to the platform, power relations within and outside the platform, role of research and development, capacity building of stakeholders, scaling up and sustainability. Lesson learnt include the need to: i) build motivation and manage expectations from the start; ii) get the right representation of actors on the platform; iii) invest in time; iv) manage power imbalances and mitigate power relations; v) create opportunities and seize them when they arise; vi) be sensitive to gender dynamics; vii) adjust platform membership when the need arises; viii) monitor external factors; and ix) embed critical platform functions in the existing structures. Some challenges encountered were: i) high expectations from platform members; ii) tight work schedules of some of the platform members, especially actors from the public sector; iii) how to sustain platform activities when funding ceases; and iv) influence of external factors such as government policy, political changes and changes in commodity price on platform activities.

Keywords: *facilitation, innovation platforms, innovation systems, institutions, institutional constraints*

Introduction

The Convergence of Sciences–Strengthening Innovation Systems (CoS–SIS) programme is an interuniversity collaborative research programme which aims to facilitate above-farm-level institutional change (such as rules and regulations, bylaws, policies, interaction patterns in the value chain) in West Africa in order to create a favourable environment for farm-level innovation, which is also often linked to technical innovation. The CoS–SIS research programme is based on the premise that African smallholders face very small windows of opportunity: the benefits that can be captured by smallholders as a result of improved technologies at the farm level are marginal. In an earlier project, Convergence of Sciences (CoS, van Huis *et al* 2007), which was a precursor of CoS–SIS, it was found that participatory technology development (PTD) had a marginal impact on improving livelihoods of smallholders, since farmers had very few opportunities they could capture by using improved technologies. To expand farmers’ opportunities, CoS researchers started experimenting with institutional change (Dormon *et al* 2007, Adjei-Nsiah *et al* 2008).

However, an impact study carried out over five years after the project showed that most innovations that required above-farm-level institutional support did not survive (Sterk *et al* 2013). This inspired CoS–SIS to give more attention to achieving sustainable above-farm-level change and focus on the interfaces between the opportunities and constraints faced by smallholders at farm level and the enabling/disabling institutional conditions above the farm level. The objectives of the programme are therefore to: i) facilitate nine innovation platforms engaged in institutional experimentation around nine “agro-domains”; ii) test an innovation systems approach to institutional change; iii) improve smallholders’ opportunities through creating an enabling institutional environment; and iv) draw and institutionalise policy-relevant lessons. The nine platforms, called Concertation and Innovation Groups (CIGs), are facilitated by postdoctoral research associates. This paper investigates how interaction and concerted action are facilitated in order to bring about institutional change in nine agro-domains in West Africa.

Case description

The work started in 2010 in three countries in West Africa – Benin, Ghana and Mali – and focuses on nine agro-domains that are important to the economies of these countries. The domains are water management, cotton and oil palm in Benin; food security (small ruminants), oil palm and cocoa in Ghana; and crop-livestock integration, sheanuts and water management in Mali (Table 1). These domains were selected before the commencement of the programme by national working groups in each country, comprising key actors in the agricultural sector in the respective countries.

Table 1: Agricultural domain selected for CoS–SIS by national working groups

Country	Domain
Benin	Cotton, oil palm (intercropping oil palm and annual crops and oil palm seed system) and integrated water management (agropastoral dams in the north and rice production in valley bottoms in the south)
Ghana	Oil palm, cocoa and food security in the north
Mali	Integrated water management, integration of crop and livestock production (both in Office du Niger) and sheabutter (<i>karaté</i>)

The entry point for each domain was identified after exploratory scoping studies (Adjei-Nsiah *et al* 2013) and diagnostic studies (Jiggins 2012) by postdoctoral research associates and doctoral students, respectively. The entry points were selected based on issues emanating from the scoping and diagnostic studies. To carry out research on institutional change, issues emerging from these studies were summarised in an analytical framework (see Adjei-Nsiah *et al* 2013). The research associates went through the different phases of the innovation platform cycle as described in the CIG cycle framework (see Nederlof & Pyburn 2012), namely scoping and preparation for CIG establishment, process management, learning and restructuring and renegotiating.

The research associates identified potential members of the platform through stakeholder analysis. Criteria used to assess the members included importance, influence and power. After identifying the members, the research associates explored their interest in becoming a member of the platform, after which a core of the identified members was invited for the first meeting. Once the CIGs were established, the research associates took on the task of facilitating the platforms. Membership of the platform is flexible and consists of value-chain actors (smallholders, public-sector service providers and regulators, private-sector service providers and policymakers).

Key issues found in the CIG work⁷

External conditions and their influence on CIG activities

External conditions outside the platform had major influences on the attainment of CIG objectives. For instance, in Mali, the functioning of the CIGs' activities was affected by the political context in the country. Most of the activities planned were disrupted due to frequent changes in the leadership positions in key organisations operating in the project areas. In the Ghana oil-palm CIG, activities were stalled for some time due to both administrative and political changes in the district where most of the platform's activities were implemented. In the case of cotton in Benin, many external factors changed, including restructuring of the extension service, reduction in the price of fertilisers and increase in producer price of cotton. These suggest the need for constant reflection and adaptation by the facilitator and the platform members.

Power relations

Power struggles existed both within the CIG and outside the CIG in most of the platforms. Most of these frictions are more or less associated with private interests, behavioural norms and formal and informal structures (Zannou *et al* 2013). In the oil-palm CIG in Ghana, many processors borrow money from Nigerian buyers at the beginning of the peak fruit production season, when fruits are cheap, and supply the oil to the buyers during the lean fruit production season, when the price of the oil is high. Since the smallholders depend on the buyers for money for processing, they feel powerless and are often perpetually indebted to the buyers. A similar situation is also found in the water-management CIG in Benin among rice producers. In both cases, CIGs have tried to address this problem by trying to organise the producers into groups, find alternative credit for them and link them to remunerative markets. At the beginning of the work of the water-management platform in Mali, less powerful actors such as smallholder rice producers were reluctant to speak in the presence of more powerful actors such as the irrigation officials, even if they knew that what the official was saying was untrue, because they feared they would be punished by being denied access to irrigation water. They started to speak only after mutual trust and understanding had been negotiated among the platform members.

In the Benin cotton sector, the import, pricing and distribution of agro-inputs were controlled by one powerful trader, who made sure that cotton growers remained dependent on high-dosage, highly toxic and high-cost crop-protection chemicals despite the collaborative efforts of the cotton extension agents, cotton farmer organisations and the national research institutes to introduce a form of integrated pest management (known as LEC). This trader has developed strong relationships with senior civil servants and politicians. In order to avoid the influence of this trader, the cotton CIG was located in N'Dali, where a private entrepreneur (not a member of the CIG) had set up a cotton value chain from input supply through to a textile mill, partly to avoid the influence of the dominant input dealer. The CIG focuses on developing the technical and institutional means to create a neem-based crop protection approach for the cotton value chain.

Role of public research and development in the innovation process

In all the platforms, research and development has played a major role in removing farm-level constraints linked to institutional innovation. For instance, linked to the oil-palm CIG in Ghana was an experimentation platform facilitated by a PhD student who experimented with diverse stakeholders including farmers, processors, mill workers, extension agents and scientists from the oil palm research institute to remove several technological constraints faced by smallholders. This group experimented on how long to store the palm fruits before

⁷ This section is integrally based on Nederlof and Pyburn (2012).

processing to produce good-quality crude palm oil that meets the standards of the export market and the industrial market. In the cotton CIG in Benin, an experiment to test the effectiveness of neem against certain pests was conducted in a participatory manner with scientists and farmers in a bid to introduce neem as an alternative pesticide. This research was facilitated by a CoS–SIS doctoral candidate in N’Dali.

Capacity building

Capacity building of smallholders played a major role in the innovation process. In some of the CIGs, such as for shea in Mali and for oil palm in Ghana, the capacities of the smallholders were strengthened in order to make them function more efficiently. For instance, in the Mali shea CIG, when the women’s cooperative sought a loan from the bank, it needed a sound financial management system. It also needed to control its stock of sheanuts so that the women could choose the right time to sell their nuts to get a good price. Therefore, one member of the CIG, SOCODVI (an NGO that specialises in business development), trained the management of the cooperative in these skills. In the Ghana oil-palm CIG, one of the CIG members representing the Ghana Export Promotion Authority sourced for a facility from his outfit to train smallholder farmers and processors in good processing practices, organisational skills and group dynamics.

Scaling up

Activities of the CIGs are concentrated at different levels depending on the country and the domain. These activities can therefore spread beyond the locality where they are carried out. This is possible because CIG members are drawn from different levels ranging from local to national. Thus, a member working in a national organisation can take lessons learnt and apply them at a national scale. For example, in the Benin cotton domain, the CIG is evaluating new cotton varieties with farmers in a participatory manner in the CIG area to identify improved varieties for cultivation by farmers. A CIG member from the cotton and fibre research centre can promote nationwide the elite varieties that are identified through the evaluation. In Ghana, the oil-palm CIG is linked up with a local experimentation group and a district stakeholder platform where the results obtained from the experimentation platform are shared with the stakeholders represented on the district stakeholder platform for wider adoption.

Sustainability

In some countries, the platforms plan to mainstream their work into the formal research and extension system. Since the constraints faced by smallholders are multifaceted, at different scales, and include technical as well as institutional issues, making the platform part of the research and extension system will effectively address these complex issues and find solutions that are well embedded in the needs and circumstances of smallholders. Involvement of local-level agricultural research organisations and the Ministry of Agriculture in the platform activities provides opportunities for the platform to be streamlined within the activities of these organisations. In Ghana, the CoS–SIS institutionalisation programme is mentoring young scientists within key research organisations of the three programme domains. A curriculum for introducing postgraduate degree programmes in the three universities involved in CoS–SIS is being developed. Nevertheless, funding and facilitation challenges still exist.

Lessons learnt

The roles played by the research associates at the various stages of the CIG cycle were examined using the CIG cycle framework. Lessons were drawn on facilitating innovation platforms and are discussed below.

Build motivation and manage expectations right from the start

A major task for the facilitator of an innovation platform is to generate interest among platform members right from the start and continuously sustain the interest. This task was performed in a variety of ways in the different platforms. In the case of the rice platform in Benin, the facilitator started by tackling relatively easy problems with the expectation that early success would whet the interest of platform members. The intention was to gradually move towards more complex problems with time. In the water-management platform in Mali, a similar approach was used. The facilitator quickly organised a labour party to clean the irrigation canal to deal with an immediate problem, although this was not the level of intervention intended by the CIG. This, however, motivated the members to participate in and support the platform activities. In the Benin CIG, however, failure of the CIG to provide the cotton smallholder farmers with a tractor marred the activities of the CIG, as they initially had high expectations that the CIG could provide them with a loan to purchase the tractor. It is therefore important for the facilitator to be clear from the beginning on what s/he will and will not do. It is dangerous to raise the expectations of platform members or local people.

Carefully consider the composition of the platform

It is critical to have the right representation on the platform at the beginning and throughout the cycle of the CIG. The platform should consist of people who could potentially make interdependent and complementary contributions to improving the conditions of smallholders. There should be high-calibre members who would be able to convince policymakers of the need for change. In the CoS–SIS programme, the platform facilitators intended from the outset to make the composition of platform membership flexible and changeable. That meant that members could come in and exit at any time they wished, depending on the issue at stake. In most cases, members indeed were brought in and exited at any time. In the Ghana oil-palm platform, for instance, there was initially no representation from the environmental protection agency until environmental issues became important in the platform activities. Having the right people on the platform at a given point in time is crucial for the success of the platform.

Be prepared to invest time

Platform facilitation requires investment of a lot of time by the facilitator, who plays a crucial role. The facilitator organises meetings, coordinates the platform activities, facilitates interaction among platform members and makes resources meant for the programme available for the operation of the platform. The facilitator reminds members of their assigned tasks and makes sure they carry them out on time, keeping the platform on track; and also helps the key actors to reach consensus, reconciling opposing views to come to decisions. When there is a conflict among platform members, it is the facilitator who mediates. In effect, the facilitator is both a broker and gatekeeper. Since facilitation takes a lot of time behind the scenes, the facilitator should have enough time to attend to these tasks.

Manage power imbalances and mitigate power relations

Power differences between actors along a value chain may be due to lack of trust among actors (as happened in the case of the rice CIG in Benin and the oil-palm CIG in Ghana). Another source of power differences could be information asymmetry. Some power differences could be identified already at the beginning of the innovation platform through stakeholder analysis. In some cases, some members may threaten to withdraw, as happened in the Ghana oil-palm CIG, while their continued presence on the platform may still be

needed. The facilitator must find a strategic way of managing the situation in order to avoid the withdrawal. This challenge was also encountered in the Benin cotton CIG: members became disappointed when their hope of getting a loan to purchase a tractor was dashed and new members were brought in when the focus of the activities shifted to neem-based pesticides. In the Mali water-management CIG, the concern was that less powerful actors were not prepared to speak in the presence of more powerful actors – the officials of the Office du Niger and irrigation authorities. The facilitator dealt with this by negotiating for mutual trust and understanding among the platform members. Power imbalances are inevitable in innovation platforms. Weaker members may need assistance. Stronger members do not need such assistance but may need to be encouraged to remain on board.

Respond to opportunities when they arise

In innovation platforms, one must create opportunities and seize them when they arise. This is illustrated well in the oil-palm CIG in Ghana, where lobbying by the platform members resulted in an opportunity: the facilitator was asked to make a presentation to the District Assembly at short notice. His quick response led to exposure of the CIG's proposal to an important high-level audience. This was critical to the success of the CIG.

Be gender sensitive

The facilitators have the task of involving different social groups on the platform, including vulnerable but also less disadvantaged groups. Making sure that women are represented on the platform and have a strong voice can be a challenge. In the oil-palm platform in Ghana and the shea platform in Mali, women dominate in the local enterprises but the representatives of the higher-level organisations on the platforms are mainly men. The facilitator's role was to ensure that women were represented on the platform – and not just token representation. The members should not be chosen just because they are women, but because they are in a position to represent the interest of a particular group and to engage with other members.

Adjust platform membership when the need arises

Continuous reflection and learning within the platform are the responsibilities of the facilitator and the platform members. With this in mind, the facilitator ensures that the necessary adjustment in the membership or functioning of the platform is undertaken as the need arises. Flexibility in the structure and membership is very important, particularly when new issues emerge. This was the case of the oil-palm CIG in Ghana, when it became necessary to bring in a member from the environmental protection agency after a major environmental issue in palm-oil processing arose but there was no expertise in this among the CIG composition at that time. Flexibility also allows the platform to adapt when unexpected problems arise, such as in the Benin cotton CIG, when a misunderstanding arose over the role of the CIG itself.

One major issue which has been difficult for the facilitators to deal with is when a member of the platform representing an organisation leaves and is replaced by another person. This new person has to start all over again, which may delay progress. If the previous member was a champion, then his/her departure becomes a big loss to the platform.

Discussion

We have demonstrated through the CoS–SIS programme that interaction and concerted action do not just happen. They need to be facilitated. The CIG created space for interaction among stakeholders who could make complementary and interdependent contributions towards institutional change. Deliberate interventions by research associates made this possible.

The cases demonstrate the role of the facilitator in achieving institutional change. In these cases, the facilitator was a relative outsider, who identified and brought together diverse stakeholders and facilitated their interaction to ease the process of negotiating joint action.

The objectives of the programme were critical in defining the role the research associate-cum-facilitator played. The fact that CoS–SIS is an action-research programme, and therefore has both research and developmental objectives, informed the criteria for selecting the research associates. Their background and current interest in research stimulated their shift in roles from a day-to-day facilitator to a reflective monitor – focusing on collecting data, analysing and documenting. Both individual characteristics (such as openness, enthusiasm, patience and mediation skills) and a background in facilitation or social sciences help. In addition, tailor-made training on facilitation of multistakeholder processes and innovation platforms was organised for them by one of the project partners: Royal Tropical Institute (KIT).

One issue that stands out clearly and is critical in facilitating institutional change concerns the time investment required. The facilitator must have time for both formal and informal contacts with all those involved at all stages of the partnership due to the multiple roles s/he plays in the innovation process. It is also important that platform members have interest in and devote time to the platform activities. Lack of time was an issue for all research associates involved in the CoS–SIS programme. Most of the platform members have busy work schedules that sometimes conflict with the platform activities. This is also a major lesson, as it highlights the need to invest in interactions and meetings.

Unexpectedly, very little money was spent in supporting the CIG activities. The CoS–SIS programme planners anticipated that such funds would be needed and had budgeted accordingly, but the facilitators managed to engage stakeholders, hold meetings, get inputs, do studies and so on, with very limited costs. In some cases, other partners contributed additional funds, namely through the Office du Niger in the Mali water-management CIG and through the export promotion authority in the Ghana oil-palm CIG.

Conclusion

Using multistakeholder innovation platforms to facilitate institutional change in smallholder agriculture is a very challenging task requiring commitment on the part of both the platform members and the facilitator. The research associates of the CoS–SIS programme have been confronted with varied facilitation challenges from the scoping phase through the building and implementation phase to the learning and restructuring phase. Although the cases synthesised in this paper are specific to the CoS–SIS programme, we have drawn out general lessons for future facilitators of innovation platforms.

References

- Adjei-Nsiah S, Adu-Acheampong R, Debrah K, Dembele F, Lassine S, Ouologuem B, Saïdou A, Vissoh P & Zannou E. 2013. Defying “the pervasive bias” against African smallholders: identifying entry points for institutional change. *Development in Practice* 23 (7): 843–856, <http://dx.doi.org/10.1080/09614524.2013.811220>
- Adjei-Nsiah S, Leeuwis C, Giller KE & Kuyper TW. 2008. Action research on alternative land tenure arrangements in Wenchi, Ghana: learning from ambiguous social dynamics and self-organized institutional innovation. *Agriculture and Human Values* 25: 389–403.
- Dormon ENA, Leeuwis C, Fiadjoe FY, Sakyi-Dawson O & Huis A van. 2007. Creating space for innovation: the case of cocoa production in the Suhum-Krabo-Coalter District of Ghana. *International Journal of Agricultural Sustainability* 5 (2&3): 232–246.
- Huis A van, Jiggins J, Kossou D, Leeuwis C, Röling N, Sakyi-Dawson O, Struik P & Tossou R (eds). 2007. Research researched: can convergence of agricultural sciences support innovation by

- resource-poor farmers in Benin and Ghana? *International Journal of Agricultural Sustainability* (Special Issue) 5 (2&3): 89–264.
- Jiggins J. 2012. Diagnosing the scope for innovation: linking smallholder practices and institutional context. *Wageningen Journal of Life Sciences* 60-63: 1–8 (www.journals.elsevier.com/njas-wageningen-journal-of-life-sciences/recent-articles).
- Nederlof ES & Pyburn R (eds). 2012. *One finger cannot lift a rock: facilitating innovation platforms to trigger institutional change in West Africa*. Amsterdam: KIT Publishers.
- Sterk B, Kobina C, Gogan AC, Kossou D & Sakyi-Dawson O. 2013. Five years after: the impact of a participatory technology development programme as perceived by smallholders in Benin and Ghana. *Journal of Agricultural Education and Extension* DOI: 10.1080/1389224X.2013.78 2819.
- Zannou ET *et al.* 2013. Power relations in innovation platforms: cases in Ghana, Benin and Mali. Submitted to *Development in Practice*.

Farmer-managed funds stimulate farmer-led participatory innovation processes

Chris Macooloo^{1*}, Geoffrey Kamau², Makonge Righa¹, Teresiah Ng'ang'a³, Ann Waters-Bayer⁴ and Laurens van Veldhuizen⁴

¹ *World Neighbors Africa / PROLINNOVA–Kenya, Nairobi*

² *Kenya Agricultural Research Institute (KARI) / PROLINNOVA–Kenya, Nairobi*

³ *PROLINNOVA–Kenya, Nairobi*

⁴ *PROLINNOVA International Secretariat, ETC Foundation, Leusden, Netherlands*

* Corresponding author. Email cmacooloo@wn.org

Abstract

In eight countries in Africa and Asia, Local Innovation Support Funds (LISFs) were piloted to explore their effectiveness in stimulating farmer-led innovation and making agricultural research and development (ARD) more accountable to and relevant for smallholders.

LISF management committees sometimes included only farmers but, in most cases, also other ARD actors. These local groups were linked through a national platform of state and non-state actors seeking to integrate farmer-led innovation into formal research, development and education. The platform designed, facilitated, monitored and learnt from the LISF piloting. In most countries, it was coordinated by an NGO, but in Kenya by an NGO and the national research institute jointly.

All participants needed time to understand that the LISF was for experimentation to produce public goods for the community rather than private goods for the individual. The overhead costs appeared high during the piloting, when only 30–40% of the available funding was actually spent on farmer experimentation and sharing. This was due to the need for training, advisory support, and monitoring and evaluation to allow joint learning about LISFs. Participatory impact assessment revealed that the LISF approach led to stronger contribution of farmers' knowledge to agricultural innovation processes, increased confidence of farmers to interact with "outsiders" in such processes and enhanced ability of farmers to govern publicly funded ARD.

It generally proved difficult for public research to engage in this approach. The greatest advances in this respect were in Kenya, probably because a research institute co-coordinated the initiative. In all countries, the LISFs generated high interest among government extension and NGOs as a promising approach to community-driven agricultural development.

The piloting showed that smallholders could indeed manage public funds for locally relevant innovation development, if given appropriate initial support. The LISF needs to be custom-made for the local capacities, level of community organisation, availability of support services and prevailing ARD policy environment. It works best when integrated into an existing programme that takes a participatory approach to rural development. The PROLINNOVA country platforms that piloted LISFs are now addressing the challenges of institutionalising them within ARD through a variety of channels ranging from government research and extension to farmer organisations.

Keywords: *decentralisation, farmer experimentation, local innovation, research funding, smallholders*

Introduction: PROLINNOVA and the idea of farmer-managed funds

In eight countries in Africa and Asia, Local Innovation Support Funds (LISFs) were piloted to explore whether availing funds to farmer experimenters would stimulate farmer-led innovation and make agricultural research and development (ARD) more accountable to and relevant for smallholders⁸. The piloting was coordinated by country-level platforms of state and non-state actors in the “Promoting Local Innovation in ecologically oriented agriculture and natural resource management” (PROLINNOVA) network. This Global Partnership Program under the umbrella of the Global Forum on Agricultural Research (GFAR) tries to integrate farmer-led participatory innovation into institutions of research, development and education.

PROLINNOVA grew out of an understanding that development of agriculture and natural resource management (NRM) does not follow a linear process of knowledge generation by formal research to be spread by extension services for adoption. Smallholders are finding site-appropriate practices through their own experimentation and adaptation (Reij & Waters-Bayer 2001, Sanginga *et al* 2009). PROLINNOVA seeks to link these farmer-led processes with formal ARD so as to enhance local learning and development. It envisions “a world where women and men farmers play decisive roles in ARD for sustainable livelihoods”⁹.

PROLINNOVA partners are convinced that: i) farmers can generate relevant new and better ways of doing things; ii) linking local creativity with new ideas builds resilience and capacity to adapt to change; and iii) recognising local innovative capacity lays a basis for true partnership among ARD actors. The national platforms encouraged identification of farmers doing things in new and better ways on their own initiative, building on local knowledge but also integrating external ideas. These local innovations became entry points for collaboration by local people and other ARD actors in joint experiments to enhance innovation processes.

However, even after farmers and scientists were brought together in such a Participatory Innovation Development (PID) process, there was often still a tendency for the scientists to dominate. At an international PROLINNOVA meeting, the partners asked: Could farmer-led PID be encouraged through farmer-managed funds? They decided to pilot a mechanism through which smallholders would directly access and control funds for innovation in agriculture and NRM and could thus decide what would be researched, how and by whom.

Most of the existing ARD funding mechanisms, including those intended to encourage participatory research, are managed by state ARD institutions. They are difficult to access and largely researcher-controlled, and farmers have little or no opportunity to influence decision-making about use of the funds. However, evidence from Latin America showed that small amounts of money made directly available to smallholders helped accelerate innovation (Ashby *et al* 2000). This inspired the PROLINNOVA action research with LISFs to explore whether it was possible to develop, implement and sustain locally managed funds that are effective and efficient in promoting local innovation (Waters-Bayer *et al* 2005).

Approach to the piloting in an action-research mode

LISFs were piloted in two Asian countries (Cambodia and Nepal) and six African countries (Ethiopia, Ghana, Kenya, South Africa, Tanzania and Uganda). The piloting involved: i) creating decentralised funding mechanisms to promote farmer-led innovation processes; and ii) evaluating, documenting and sharing the experiences so as to learn how LISFs could promote local innovation. The French-funded DURAS (Promoting Sustainable Development in Agricultural Research Systems) supported initial piloting in four countries in 2007–08.

⁸ This term includes peasant/family smallholders, pastoralists, forest dwellers and artisanal fisherfolk.

⁹ Formulated jointly by PROLINNOVA partners at the Country Programme Coordinators Meeting on 5–7 June 2007 in Entebbe, Uganda (Waters-Bayer & Espineli 2005), and “genderised” in the 2009 meeting in Nepal.

Rockefeller Foundation and DGIS (Netherlands Directorate General for International Cooperation) supported more systematic action research in eight countries up to 2012.

The action research was designed to allow each country team to develop and test models for implementing LISFs that would fit local political and institutional realities. Inception studies were made to identify best entry points and most feasible implementation modalities. All pilots followed jointly defined key principles of LISFs:

- Funds are made accessible directly to farmers or their groups;
- Grants are used for innovation, experimentation and learning by farmers;
- Farmers and their organisations play a strong role in deciding on allocation of funds.

The country team set up and built capacities of local Fund Management Committees (FMCs), which made open calls for proposals. The FMCs comprised in some cases only farmers but in most cases also other ARD actors. Men and women farmers (individuals and groups) submitted proposals of 1–2 pages. The FMCs selected the grantees and provided the resources for experimentation and innovation led by farmers, who then shared their results more widely in the community and sometimes beyond.

The decentralised design of the LISFs called for a research framework that could accommodate the diversity of LISFs tested yet could generate information comparable across countries. The country teams used a common monitoring and evaluation (M&E) framework to monitor 22 jointly identified indicators of how the LISF functioned as a funding mechanism. A participatory impact assessment guideline was also developed for the pilot (Triomphe *et al* 2010, 2012).

In addition, FMC members conducted their own M&E to see how the grantees used the funds. Their main tool was the grantee's end-of-grant narrative and financial report. Where literacy levels were low, an oral report to a community or farmer-group meeting took the place of a written report. M&E findings fed into review of LISF design and implementation, allowing modification where needed.

Joint learning through action-reflection cycles took place at three levels:

1. *Community/District*: The farmer groups, FMC, local ARD staff and local administration involved in piloting the LISFs learned by doing and through fairs, training, team meetings and M&E visits and – if needed – adjusted how they assessed the proposals and managed the fund;
2. *National*: Through workshops to analyse LISF implementation and impact assessment, the multistakeholder country platform reviewed the feasibility and effectiveness of LISFs and sought ways to mainstream them as a complement to conventional ARD approaches;
3. *International*: The country teams learned from each other and from resource persons through annual international meetings of project partners; phone conferences to discuss progress; email exchange (of formats, selection criteria etc); and backstopping by resource persons (email and face-to-face). In a “writeshop” in 2011, members from the eight country teams presented their findings on the LISF pilots and distilled main lessons learnt across all countries.

Main features and findings in LISF pilots

LISF design

Depending on differences in local conditions and capacities in the eight countries, basically three models for implementing the LISFs emerged:

- *Centralised multistakeholder model*: Applications for grants were sent to a national or subnational FMC for assessment (Nepal, Cambodia and Tanzania). This allowed strong quality control but required more time for decision-making and led to less capacity

strengthening at lower levels and less influence of farmers in mobilising and screening applications;

- *Semidecentralised multistakeholder approach*: Farmers sent proposals to a district-level multistakeholder committee for assessment by research and development staff and farmer representatives (Kenya). This allowed joint deliberation and learning by farmers and support agencies on what should be funded; quality control was still fairly strong; and support agencies were more easily involved in the joint experimentation. This approach led to relatively high costs for transport and allowances to attend meetings and for time/salaries of agency staff involved;
- *Decentralised farmer-managed approach*: Farmers applied to community-based organisations (CBOs) with their own screening committees, often assisted by a support agency in organising the process. Accessibility for smallholders was high and screening costs were low (Uganda and Ethiopia). Initially, the quality in the screening was low, while farmers were learning the LISF principles. The grants also tended to be limited to farmers' informal experimentation, as there were few in-built mechanisms for other stakeholders to interact with farmers. Costs of strengthening CBO capacity were higher, but this approach promised greater sustainability.

Criteria for screening applications

Although the models for LISF implementation differed, there was great coherency in the main criteria used in screening farmers' proposals for funding:

- Idea driven by the farmer applicants (not proposed by advisors or scientists);
- Innovation appeared sound in economic, environmental and social terms;
- Innovation applicable by resource-poor farmers using low-cost, locally available inputs;
- Value addition appears achievable through LISF support;
- Applicant(s) willing to share results with others (public funds for public goods);
- Proposal is for experimentation and learning, not for farm investment.

Grants made and how they were used

Table 1 shows the number of applications made and percentage approved in each country. Where CBOs played a central role in the LISF process, the number of applications received and approved tended to be higher and the grants smaller. PROLINNOVA–Cambodia worked through partner organisations that approved all kinds of proposals for experiments, whereas experimentation with local innovations was prioritised in other countries.

Table 1: LISF grants made per country

Country	Period	No. of applications	Percentage approved	Average size of grant (€)	Range in size of grant (€)
Cambodia	2006–11	270 ¹⁾	79%	61	7–125
Ethiopia ²⁾	2008–10	142	75%	33	13–108
Ghana	2008–11	188	52%	122	10–410
Kenya	2008–11	125	30%	248	85–550
Nepal	2008–11	119	87%	103	5–500
South Africa	2006–11	77	32%	956	51–1670
Tanzania	2009–11	24	92%	533	294–1300
Uganda	2007–11	279	65%	48	11 – 295
TOTAL		1224	64%	76	5–1670

1) Data exclude applications processed from own revolving funds managed by farmer groups

2) Based on data for 2010 only

LISF grants were on average less than €100, and ranged from €5 in Nepal to €1670 in South Africa. The smaller grants were used mostly to buy tools and equipment to improve a local innovation or to buy inputs, e.g. seeds, for a simple experiment (e.g. Ghana, Uganda and Cambodia). The grants were larger if costs of external services were included, e.g. laboratory analysis of new products or involvement of research staff (South Africa and Tanzania).

In order of frequency, the main type of activities that were funded through the LISFs were:

1. *Farmer experimentation*: Grants allowed farmers to do small-scale, systematic experimentation and/or data collection, individually or together with other farmers;
2. *Improving farmer innovations*: Small grants (less than €50) allowed farmers to improve new things they were working on, usually with little or no systematic experimentation or data collection;
3. *Farmer-led experimentation with research and/or extension staff*: Farmers worked with support agents to do systematic experimentation and data collection; the budget included some costs of involving the support agents; the joint experimentation was initiated and controlled by farmers;
4. *Training and learning by farmers*: Some LISF grants supported innovation-related activities such as training by farmer innovators, farmer-led documentation and learning visits by farmer groups to study innovative experiences elsewhere.

At first, proposals approved by CBOs were mainly related to farmer experimentation. Quality of proposals and approval rates increased as the farmers started to realise that the LISF was not meant to finance regular farming activities and thus differed from conventional investment funds. After one or two grant cycles, the level of complexity of experiments and involvement of other actors increased. Some farmers in Ghana and Kenya started paying travel costs and allowances to government staff for providing technical advice. This “business unusual” approach indicated a change in mindset on both sides.

The impact assessments revealed very few cases of misuse of grants to farmers. In some cases, farmers received the funds too late in the season to be able to use them in that season (e.g. Tanzania and Cambodia). Some groups decided to lend the money to members during the off-season to be repaid with interest at the start of the next season to use in the planned experimentation. Though technically not fully in line with the LISF agreement, this practice can also be seen as a sign of initiative and ownership by the farmers involved.

Effectiveness of LISFs

The extent to which the piloting led to effective modalities for farmer-managed funds was assessed according to several indicators, only some of which are highlighted here:

- *Generating applications from farmers*: The LISF modalities chosen in the eight countries led to a regular flow of applications, 64% of which could be approved (Table 1). Calls for proposals were made mainly through fieldstaff of governmental and NGO partner organisations and farmer leaders. The teams in Kenya and South Africa prepared simple brochures on the LISF. In Ethiopia, news was spread through information sheets posted on local government buildings. Only in Nepal were mass media used: the call was spread through an NGO-based radio station.
- *Applications from women farmers*: Generally, except for a low rate in Ghana, about 40–50% of individual applications were submitted by women. Greater decentralisation of LISF operation to CBO level lowered the “barrier” to women’s taking part, allowed more guidance to be given to them and generated a larger number of fundable proposals by women (Uganda, South Africa and Kenya).
- *Percentage of applications approved*: Acceptable applications from farmers were encouraged by:

- Decentralising LISF management to CBOs, which allowed rapid spread of information among farmers and created a support capacity for the application process at local level;
 - Encouraging proposals for informal farmer “experimentation” with own innovations, which often lacked a systematic approach to research; the LISF grant served more as a recognition of the farmers’ creativity and as an incentive for them and others to continue innovating;
 - Actively involving several partner organisations working in participatory rural development and able to link LISF work with their own programmes, e.g. in Ghana and Kenya;
 - Allowing LISF applications that did not directly link to local innovations but involved farmer experimentation with introduced ideas or practices, e.g. in Cambodia.
- *Time needed to process grants:* Across all countries, the average processing time needed from application receipt by the screening body to final decision-making (approval or rejection) was about 70 days. This did not include the time for preparing the application and disbursing the funds. The total time was shorter where fund operation was more decentralised.

Cost-efficiency of LISFs

Given the small amounts involved per grant, a major challenge for the LISF was to find cost-efficient ways to manage the process. About 30–40% of total funds for LISF piloting in the eight countries was disbursed to farmers; about 15% was used for training farmers and fieldstaff; and up to 55% for costs of partner organisations giving advisory support and for project coordination, policy dialogue, M&E and disseminating lessons learnt. The piloting costs included capacity-strengthening activities at farmer and fieldstaff level, the benefits of which go beyond the LISF process. Under regular operating conditions, 70–80% of the funds could go directly to farmers.

Impact of LISF process and fund-supported activities

In the final year of the action research, each country team made a participatory impact assessment (PIA) of the LISF mechanism in terms of:

- Extent to which LISF support led to development of improved farming practices and systems;
- Extent to which these practices and systems spread to other farmers and improved livelihoods;
- Change in farmers’ capacities to access relevant information and to develop technical and socio-organisational innovations;
- Change in openness and interest of ARD agencies to work with local innovators and groups.

The PIA methodology included semistructured interviews and focus-group discussions with FMC members, grantees, nongrantees, local authorities and staff of supporting organisations, plus collection of case stories and holding multistakeholder assessment workshops.

Development of improved farming practices and systems

The PIAs showed that LISF funding support led to (further) development of locally relevant, improved agriculture and NRM practices and systems. This, in turn, led to livelihood improvements for the farmer innovators directly involved (see example in Box 1).

Topics and examples of innovations developed, improved or validated with LISF support included:

- *Alternative livestock feeds*, e.g. for poultry and small ruminants, at lower cost than commercially available feed mixtures (Kenya);
- *New (cash) crops*: e.g. chilli peppers, with new forms of collective marketing (South Africa);
- *Soil fertility management*: e.g. liquid organic manure (Uganda);
- *Crop protection*: e.g. combating bacterial wilt in *enset* (staple food crop in southern Ethiopia); storing seed onions with the wild plant *barakuk* (Ghana);
- *Animal housing*: e.g. using wooden frames as floors in goat sheds combined with sacks hung below the frames to collect goat dung and urine separately (Nepal);
- *Subsurface drainage of waterlogged fields*: e.g. making underground canals connected to water-collection ponds to save water for irrigation in the dry season (Ethiopia);
- *Improved beehive construction*: e.g. combining ideas from introduced and traditional beehives, using local materials, to improve honey and beehive sales (Ethiopia and Kenya).

Box 1: LISF support to improve a finger-millet nursery innovation

Simon Masila in Machakos District, Kenya, developed a system for planting finger millet through seedlings grown in a nursery, to make maximum use of limited and unreliable rainfall. His initial success, a good harvest where other farmers failed, encouraged him to apply for LISF funding to do more systematic data collection and analysis together with other farmers. As a result of this work and increased exposure through the LISF grant, the practice has spread to neighbouring divisions and is improving the income of smallholders. Various other innovations are emerging from this initial innovation: some farmers started establishing the nurseries in small containers; others have used old mosquito nets to protect the nurseries from pests; others are experimenting with different ways of irrigating the nurseries (Source: Kamau *et al* 2012).

Spread of innovations and livelihood impacts

The extent of spread of innovations and experimental results to other farmers could not be analysed in detail in most PIAs, as these were done relatively soon after LISF grants had been made. The impacts on livelihoods tended to be framed by grantees and others in qualitative terms as follows:

- *Greater food security and household income* through identification of locally suitable crop varieties, producing more food for home and sale and selling the innovation (e.g. new type of beehive), thus adding a source of income for the household;
- *Increased investment in farming*. Some LISF grantees saved more and re-invested savings in farm inputs; Nepalese farmers reported that involvement in LISF gave them the understanding and confidence to interact with the bank for other purposes, e.g. savings and credit;
- *Position of women improved*: Where good applications could be mobilised from women, this strengthened their position, e.g. in Kenya, the Pundo Women's Group received a grant to develop *Moringa* soap; this raised their income, brought them community recognition and gave them confidence to approach the Kenya Bureau of Standards to analyse the soap.

Capacities of farmers to innovate

The PIAs indicated that involvement in the LISF increased farmers' capacities to *access relevant information and to innovate*. Farmers reported more sharing on their innovative work in the village, greater recognition by the community and external agencies, increased self-confidence to interact with outsiders in innovation and better links with other stakeholders.

The LISF stimulated and *strengthened farmers' capacity to experiment*. It reduced some of the risk inherent in trying out new things. Farmers were exposed to different options and

learned how to compare them systematically. The grantees' successes encouraged other farmers to test new farming methods. Some non-grantees started doing their own experiments without external funding.

Farmers involved in managing the LISF referred to *increased social organisation* around managing local ARD and funds for it. They became better able to handle finances on their own. The farmers in FMCs felt their capacities had been improved in organisational management, leadership skills, planning, recordkeeping and M&E. They said they were better able to think about innovation and manage innovation funding, to critically assess interventions and to make informed decisions on whether to participate in externally initiated projects or not.

Interest of ARD agencies to support farmer-led PID

According to the PIAs, the LISF approach forged new links between farmers, extensionists and researchers and led to greater contribution of farmers' knowledge to innovation processes. Scientists visited and advised farmer innovators and replicated their experiments on station. Extensionists organised field days to discuss local innovations and experiments. In Cambodia, 68% of the partners (Provincial Departments of Agriculture, NGOs, universities) felt they had greatly improved their knowledge and capacities to collaborate with each other and with farmers. Farmers stated that ARD staff showed more interest in local knowledge and ideas. In Ethiopia and Ghana, farmers and government staff stated that participatory approaches to extension became more widespread in the areas where the LISF operated. Involvement of field agents in the piloting in Ethiopia led to their increased awareness of local innovation processes and closer partnership between them and farmers. This contributed to institutionalisation of farmer-led joint research at district level in the government services (Fanos *et al* 2011).

Challenges

Reaching a common understanding of the LISF concept

All country teams faced an initial challenge to convey to farmers the main focus of the LISF on generating and spreading new ideas, knowledge and practices. This differed from the microcredit and production-oriented investment funds that generate private goods to benefit individual farms. LISF funding generates public goods, as the new knowledge and practices developed also benefit other farmers. Issues of intellectual property rights did not create a barrier where it was clear from the outset that farmers who received support through the LISF were expected to share the findings of their experimentation.

Improving cost efficiency

The LISF will be more cost-efficient during regular operation after the action-research phase, but it would be difficult to reduce the costs of the agencies facilitating LISFs (NGOs, extension, research) to below 20%. Options to improve cost efficiency include:

- Processing larger LISF grants to achieve economies of scale, after farmers start using LISFs for more comprehensive proposals or larger-scale experimentation;
- Expanding geographical coverage of the LISF to increase total number of grants;
- Increasing the role of farmers and CBOs in LISF management, i.e. greater decentralisation;
- Streamlining and standardising procedures and formats (e.g. for applications, assessment, agreements) with a schedule and regular deadlines for each step in the LISF process;
- Focusing the more costly multistakeholder screening activities on the larger applications and simplifying the screening of smaller applications by involving only 1–2 key actors.

Involving formal researchers

In most countries, it proved difficult to involve staff from research centres and universities in the farmer-led experimentation. Farmers initially wanted to experiment on their own, using local ideas and advice, and research institutes had their own agenda and little room to support farmer initiatives. A notable exception was KARI, which was directly involved in M&E of the LISF piloting and linked farmer experimenters and KARI researchers, e.g. in testing different millet and sorghum varieties sown in nurseries and transplanted (Box 1). In all countries, however, the LISFs generated interest from extension agents to become more involved in farmer-led experimentation, to the extent that their institution allowed this.

Scaling up

If the LISF is to become a longer-term funding mechanism that reaches out widely to smallholders, it needs to find a permanent institutional home. PROLINNOVA seeks to establish LISFs that are independent of external donors and are part of the regular ARD funding system in the country. The country teams are exploring several strategies to scale up LISFs while retaining their smallholder focus and farmer-led character (PROLINNOVA 2012):

- *Set up fund/facility under a national farmer organisation (FO):* The team in Cambodia is working in this direction, which is a serious option only where there are strong and independent FOs interested in smallholders and innovation processes. The country team would initially need to advise the FO leadership in operating the LISF;
- *Integrate into local government administration:* The teams in Ghana, Kenya and Tanzania see possibilities for an increased role of local government with greater decentralisation. Local LISFs could be implemented under or co-funded by the local government. In Tanzania, one district government has already provided co-funding for LISF work;
- *Integrate into Ministry of Agriculture (MoA) extension:* Integration into the regular operations of the MoA would allow scaling out the LISF countrywide and could mobilise staff to facilitate this. Given the role that MoA staff already played in most LISF piloting, this integration may be fairly easy, but government agencies often have bureaucratic procedures and limited resources;
- *Establish National Innovation Fund:* This option, inspired by National Innovation Foundation in India (www.nifindia.org), would mean setting up a new entity with the specific mandate to support farmer-led innovation; key stakeholders would be represented in its governance;
- *Integrate into numerous agricultural development organisations:* Some country teams (Ethiopia, Ghana and Uganda) encourage all partners, state and non-state, to incorporate the LISF into their regular programmes. This scaling-up approach depends less on a single organisation but would not provide a capacity to promote LISFs in other organisations or in other parts of the country;
- *Base LISF concept in self-managed and self-resourced CBOs:* CBOs could establish their own LISFs in the form of revolving funds to ensure continuation. Cambodian partners used this principle and many farmer experiments were funded directly from funds repaid by previous recipients. This option also does not provide a capacity to continue catalysing LISFs in other parts of the country.

Besides these various channels for integrating LISFs into formal ARD, the PROLINNOVA partners are also incorporating the LISF into community-level funding for climate-change adaptation.

Policy recommendations

The LISF piloting has shown that creating a decentralised farmer-managed funding mechanism opens the way to a collaborative innovation process. Contrary to the common belief that higher-level offices should manage all research funds, the piloting revealed that funds could be managed at the grassroots when capacity-strengthening and reflective-learning activities allow adaptation of the funding mechanism to the local institutional conditions.

When moving from pilot to scale, the LISF process needs to be streamlined to reduce fund-handling costs and achieve economies of scale; in Kenya, this could perhaps be achieved by using the M-pesa system for fund transfer. Appropriate institutional arrangements are needed to make LISFs accepted mechanisms for channelling part of ARD funds to catalyse local innovation processes and to have a positive impact on food security, livelihoods and NRM.

The main policy recommendations that emerge from this action research are:

- To advance smallholder farming, national policy should support farmer-managed decentralised funding mechanisms to link farmer innovators and the formal ARD sector; this can give farmers more opportunity to learn together with other knowledge-holders, to contribute their own knowledge to agricultural innovation and to have a stronger voice about ARD form and content;
- Instead of centralising and homogenising ARD for smallholders – or even an LISF approach for smallholders – funding agencies and ARD decision-makers should promote a multitude of local learning platforms to develop locally appropriate innovations – also in managing ARD funds – and should create spaces to learn from this diversity in innovation.

Conclusions

Some general lessons that have been learnt during LISF piloting are:

- *Smallholders are interested in and capable of managing funds for locally relevant innovation.* Once they understood the LISF concept, their proposals became more focused on innovation and they became creative in expanding the type of activities proposed for funding, e.g. training other farmers and experimenting with new practices seen elsewhere.
- *LISFs must be tailor-made for each setting.* The core LISF principles – giving smallholders direct access to funds, supporting farmer-led innovation and farmer co-management of funds – were operationalised in different contexts in different ways. When starting an LISF, it is crucial to tailor it to the local realities with respect to CBO capacities, availability of NGO and ARD actors, and the diverse policy and legal regimes.
- *Developing the model takes time.* All actors involved from farmer to national level need time to understand the purpose of the LISF to produce public goods for the community rather than private goods for the individual. Decentralising the LISF is a gradual process: initially, higher-level actors may play a bigger role in facilitating the process and advising on proposal approval but, as the LISF system gradually matures, decisions can be made at lower levels.
- *LISFs should be linked with existing participatory programmes* of development organisations, whether CBOs, NGOs or governmental, that can give needed support; the management of these organisations should create room for staff to build LISF support activities into their regular work.
- *Involvement in decentralised LISFs enhances farmers' role in governing ARD.* Decentralising LISF tasks and responsibilities to FOs and CBOs at local level leads to strong farmer influence on decisions about local ARD. In all eight countries, the farmers involved in FMCs and local experimentation gained confidence to express themselves in public fora with formal research and extension staff and thus to challenge public services, such as refusing introduced projects that did not meet their needs.

References

- Ashby J, Braun A, Gracia T, Guerrero M, Hernandez L, Quiros C & Roa J. 2000. *Investing in farmers as researchers: experience with Local Agricultural Research Committees in Latin America*. Cali: CIAT (International Centre for Tropical Agriculture).
- Fanos M B, Guesh W, Luel H, Hailu A & Waters-Bayer A. 2011. Assessing the level of institutionalising Participatory Innovation Development in Tahtay Maychew District, Ethiopia. PROLINNOVA Working Paper 32. Leusden: ETC Foundation.
- Kamau GM, Kirigua V, Righa M & Ng'ang'a T. 2012. Farmer Access to Innovation Resources: experiences with piloting Local Innovation Support Funds in Kenya. Nairobi: PROLINNOVA–Kenya.
- PROLINNOVA. 2012. Farmers' direct access to R&D resources accelerates local innovation. Policy brief. Leusden: PROLINNOVA International Secretariat, ETC Foundation.
- Reij C & Waters-Bayer A. 2001. *Farmer innovation in Africa: a source of inspiration for agricultural development*. London: Earthscan.
- Sanginga P, Waters-Bayer A, Kaaria S, Njuki J & Wettasinha C (eds). 2009. *Innovation Africa: enriching farmers' livelihoods*. London: Earthscan.
- Triomphe B, Vitou S & Wongtschowski M. 2010. Co-designing an impact assessment approach for alternative funding schemes to support local innovation: lessons from Cambodia and Ethiopia. Conference on Innovation and Sustainable Development in Agriculture and Food (ISDA), 28 June–1 July, Montpellier, France.
- Triomphe B, Wongtschowski M, Krone A, Waters-Bayer A, Lugg D & Veldhuizen L van. 2012. Providing farmers with direct access to innovation funds. In: *Agricultural innovation systems: an investment sourcebook* (Washington DC: World Bank), pp435–441.
- Waters-Bayer A & Espineli M (compilers). 2005. Report on PROLINNOVA Country Programme Coordinators Meeting, 5–7 June 2005, Entebbe, Uganda. Leusden: PROLINNOVA International Secretariat.
- Waters-Bayer A, Veldhuizen L van, Wongtschowski M & Killough S. 2005. Innovation support funds for farmer-led research and development. *IK Notes* 85. Washington DC: World Bank.

For more information about PROLINNOVA's work, see www.prolinnova.net

Learning from agricultural research for development in sub-Saharan Africa: development of evidence-based propositions to improve food security outcomes

Luis C. Rodriguez^{1*}, Yiheyis T Maru¹, Daniel H. Walker¹, Ray Ison², Wolf Wanjura¹, Ian Kershaw³ and John Dixon⁴

¹ Commonwealth Scientific and Industrial Research Organisation (CSIRO) Ecosystem Sciences, Australia

² Monash University, Melbourne, Australia

³ Australian Agency for International Development (AusAID), Canberra, Australia

⁴ Australian Centre for International Agricultural Research (ACIAR), Canberra, Australia

* Corresponding author. Email: luis.rodriquez@csiro.au

Abstract

There is a long history of investment in agriculture research for development (AR4D) in Africa to promote food security and enhance livelihoods. However, donors, researchers, development agencies and practitioners in project design often do not have ready access to high-quality information about what works, in which settings and with and for whom.

The Food System Innovation for Food Security (FSIFS) initiative was established in May 2012 to investigate the effective application of science and evidence-based approaches to the development, implementation and evaluation of food-security interventions with particular emphasis on the Australian Development Assistance programme.

Evidence-based lessons from selected food-security projects and programmes in sub-Saharan Africa are reported based on an in-depth review of seven recent programmes (the African Food Security Initiative, SIMLESA, SIMLEZA, Convergence of Sciences, Research into Use, the Sub-Saharan Africa Challenge Program and the Millennium Villages Project) through semistructured interviews with 27 experts working in the seven projects augmented with extensive review of published and grey literature. The aim was to enhance understanding of what works and what does not work in food security research in Africa.

Evidence-based propositions were developed using a thematic analysis of the data set. A large number of observations associated with project implementation experience were reviewed to identify good practices that: i) had significant implications for practice; ii) for which there was robust evidence; and iii) which might be expected to be worth considering in other circumstances and initiatives.

The resulting propositions are statements of good practice with respect to some aspect of interventions for food-security research that, if adopted, are expected to contribute to better food security outcomes. The propositions are intended to inform design and investment decisions and improve implementation but also to structure debate and learning on effective practice. Each proposition is supported by: i) an *explanation* that expands the proposition; ii) a summary of the public *evidence* for the proposition; iii) *examples* from the sample projects that ground the proposition in context and practice; iv) the *design implications* of the proposition for new interventions; v) hypothesised *consequences* for food security; vi) a summary of *assumptions underpinning* the proposition; and vii) a summary of *counterviews and counterevidence* to the proposition.

Examples of the propositions and the consultative process to refine them are presented and some concluding remarks highlighted.

Keywords: *agricultural research for development, sub-Saharan Africa*

Introduction

Food insecurity is one of the most important challenges of our times. While food insecurity is pervasive, it is highly concentrated and persistent in sub-Saharan Africa and South and Southeast Asian countries.

Since the declarations of the UN Millennium Development initiative at the turn of the century, there has been a surge of global attention and investment in a multitude of international and national interventions (research, humanitarian and development) to improve agriculture and the food system to promote food security. These interventions generate a significant amount of information about social, economic and environmental baselines, definition of methodological approaches, implementation of field activities, refining of monitoring and evaluation systems, as well as reviews of projects and their impact. Those who have been and currently are involved in these interventions also hold information and insights that complement the written material, providing a rich data set to extract lessons able to increase our understanding of what works and what does not work in African food-security projects.

The challenge is how to extract these lessons in the face of information overload, contestability of insights and context specificity. In this regard, the Food System Innovation for Food Security (FSIFS) initiative was established in May 2012 to investigate the effective application of science and evidence-based approaches to the development, implementation and evaluation of food-security interventions with particular emphasis on the Australian Development Assistance programme, including in sub-Saharan Africa (SSA).

The aim of this paper is to present a methodology to extract those lessons learnt in SSA based on a set of propositions to promote discussion and debate about contentious food-security issues; and to show an example of the content and structure of these propositions and their refinement based on consultative processes involving researchers, donors and practitioners based in Australia and Africa.

The rest of the paper is organised as follows: The next section will briefly describe the methodology to define a proposition, including the introduction of key concepts. We will then present the data set and an example of the content and structure of a proposition developed for an Australian food-security project, and later discuss the process of engagement with communities of interest for its refinement and application. The last section will provide some concluding remarks.

Methods

Over the last two decades, there have been two broad developments that attempted to address information overload systematically: data mining for discovery and systematic reviews. Data mining involves the use of sophisticated data-analysis tools to discover previously unknown, valid patterns and relationships in large data sets. These tools can include statistical models, mathematical algorithm and machine-learning methods. Consequently, data mining consists of more than collecting and managing data; it also includes analysis and prediction. A systematic review aims to provide an exhaustive summary of literature relevant to a research question. It is a focused literature review that tries to identify, appraise, select and synthesise all high-quality research evidence relevant to that question.

Unlike data mining and systematic review, which rely entirely on published data, we developed a consistent approach to use both published data and expert knowledge to derive an initial set of good practices and their counterviews within a given domain of interest, in our case, food-security interventions. This set is then critically reviewed, discussed, debated and supported or challenged by evidence coming from participatory processes involving a broader community of interest. These processes create ownership, encourage the use and refinement of the information and facilitate social learning.

The development of propositions is therefore an attempt to improve on conventional passive reporting on information collected from interviews and literature reviews that are generally not used by the target audiences, because of their limited engagement during the discovery process. Thus, the development of propositions has two phases: in an initial phase, a small group of researchers and practitioners define a set of evidence-based insights and counterview for a particular topic (i.e. a proposition) and, in a subsequent phase, a broader community of interest regularly reviews and refines the propositions to update the evidence, and include or remove propositions from the data set, keeping it as an open live document.

The food security literature is rich in “lessons learnt” that, in most cases, are built on generalities or well-known management principles rather than based on evidence. We have identified that those lessons could be included in three categories – Axioms, Propositions and Observations – based on their robustness, applicability and novelty, as shown in Table 1.

Table 1: Concepts used in the process of defining propositions for debate and discussion

Concept	Example
Axioms – (close to) self-evident truth	Stakeholder participation is critical for sustained project impacts.
Propositions – proposals on best practice that have a solid evidence base but remain contested	Projects using innovation platforms to improve food security should be designed to run for longer than four years.
Observations – things that stand out from review of evidence but where implications are unclear	In the Sub-Saharan African Challenge Program, establishing operational innovation platforms often took more than half the planned project life.

As Figure 1 shows, the review and analysis of information allow researchers to capture a large number of observations that, in many cases, could be anecdotal since the evidence is weak and usually correspond to a single data point. The number of axioms is generally small and based on well-known principles that are generally already included in the design of food-security projects. Propositions themselves correspond to a grey area where there is solid evidence, but a few counterviews are also available, opening the door for context analysis, discussion, debate and further research.

Data set and proposition example

Data set

Practical aspects of data collection needed to be addressed. An initial list of projects to be reviewed was elaborated, based on a set of pragmatic considerations. External consultants were asked to review the list with the intention of maintaining a balance between Australian- and foreign-funded projects, as well as to ensure the inclusion of different development agencies and food-security approaches (Table 2).

Researchers and leaders of the shortlisted projects were engaged following the guidelines of the FSIFS ethics agreement. Individual respondents were contacted to arrange dates and time for semistructured interviews either face to face or by telephone. Based on the project cycle framework, the interview covered five major topics: i) stakeholder engagement; ii) complexity; iii) monitoring and evaluation; iv) impact sustainability; and v) recommendations for new Australian AR4D investments. The final data set included written material, i.e. books, journal articles, conference proceedings, evaluation documents and reports from each of the six projects, as well as 28 interviews from respondents affiliated with 14 different organisations including multilateral, donor and development agencies, national agricultural research institutes and NGOs operating in Africa.

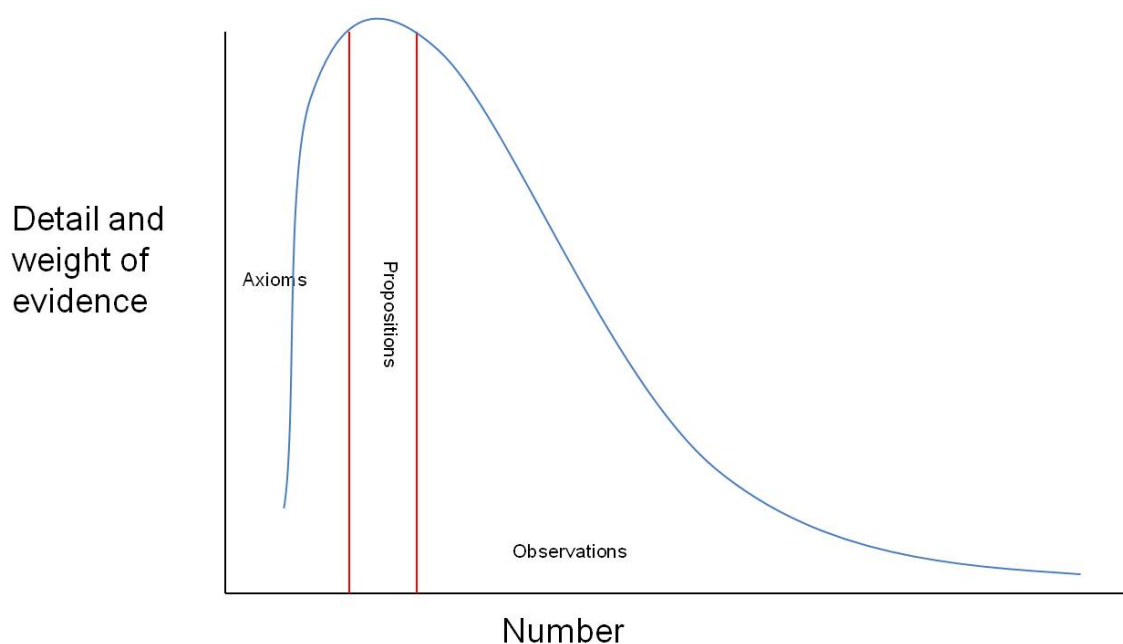

Figure 1: Axioms, propositions and observations

Table 2: Focal projects reviewed

Focal project acronym	Full name
AFSI	Australia Africa Food Security Intervention
SIMLESA	Sustainable Intensification of Maize and Legumes cropping systems for food security in Eastern and Southern Africa
SIMLEZA	Sustainable Intensification of Maize-Legume Systems Eastern Province of Zambia
CoS	Convergence of Sciences
RIU	Research Into Use
SSA CP	Sub-Saharan Africa Challenge Program
MVP	Millennium Villages Project

Example of a proposition

In an initial phase, a set of propositions was developed by a group of researchers based on the evidence collected from the involved projects. The proposition has the following structure:

Heading: Transition of smallholder farmers from subsistence to commercial production is significantly constrained by poorly developed market information systems.

Explanation: Food production in SSA is strongly fragmented and mostly oriented to self-consumption since trading food surpluses is challenging because of a lack of updated information about supply, demand and prices, as well as of information on the reliability of the sellers and buyers. Farmers and traders normally get the information through their personal networks involving large transaction costs. In order to promote market-oriented food production, farmers and traders require effective market-information systems to make better decisions about what to produce, when to buy and sell, where and at what price.

Evidence: Agricultural markets in SSA are be characterised by limited and asymmetric market information. In many countries and regions, transaction costs are so high that farmers and traders may choose not to engage in the market. Farmers might choose to produce for subsistence purposes if they cannot agree on satisfactory prices, or when there are doubts about when or whether they will be paid agreed prices (Tollens 2006, respondent KIT 2 2011). Market research in SSA indicates that, where food staple markets dominate and small-scale traders play an important role, market development policies should promote more formal trading through the creation of institutional arrangements and use of technologies to provide market information (Diao & Hazell 2004). All across Africa, market-information systems have been established with support of donors and development agencies such as USAID, FAO, WTO and IFPRI – e.g. Esoko in Ghana, Malawi and five other countries; KACE (Kenya Agricultural Commodity Exchange); SIMA (Sistema de Informação de Mercados Agrícolas) in Mozambique – to collect and distribute reliable, regular and consistent information, as well as to open up opportunities for the private sector to provide these information services after the activities funded by donors finish (Muganga 2011, respondent Malawi 2).

The evaluations of these systems are consistently positive; thus, in Malawi the USAID-funded Market Linkages Initiative (MLI) supported the country implementation of the Esoko market information system (originally designed in Ghana) that proved to be the most cost-effective option to provide benefits for Malawian farmers and traders (MLI 2011). In West Africa, recent evaluations of Esoko showed increased trading volumes and 10% revenue increase among the Ghanaian smallholder farmers that receive regular market information (Subervie 2011).

Example: Providing Market access to Kenyan small holders

The Kenya Agricultural Commodity Exchange (KACE) works with various private- and public-sector partners as well as donors such as the Rockefeller Foundation, USAID, the Hans Seidel Foundation and CABI to provide farmers with market information, capacity enhancement activities, business training and technical assistance through a combination of vehicles and technologies. These include: i) traditional rural market-information centres and clearing houses; ii) radio programmes providing virtual trading floors, matching offers and bids for commodities, and provision of inputs and services; and iii) modern technologies such as Internet-based platforms and mobile phone message services SMS. The KACE model shows that farmers and small agribusiness in remote rural areas are willing and able to pay for additional market information and that SMS provider companies are willing to operate based on negotiated fees and margins. Impact assessment of KACE indicates that, in the areas covered, 80–90% of the farmers use their services, reaching one million farmers and 250,000 small-scale traders on a daily basis through radio, SMS or direct contact, improving commercialisation and earnings for farmers in the range between 22% and 150% depending on the commodity, the location and the season (Karugu 2011). As a result of increasing user demand, KACE is franchising the information centre models to local entrepreneurs as market resources centres that also provide extra services for a fee such as transport, storage and weighting in order to enhance their economic viability (KIT & IIRR 2011).

Assumptions and their implications

- The cost of membership to the market information system and the cost of receiving information through mobile phone calls and SMS are affordable. If the cost is excessive, the service will not be used if the financial gains of improving trading are outweighed by the cost of membership and information gathering.
- The information is accurate. If the information is not up to date and accurate it will be meaningless and the system will not be adopted.

- The transaction costs of getting market information through personal networks are high. If the cost of collecting information through market information systems is higher than the transaction costs of getting it through personal networks, the system will not be adopted.
- Farmers are able to use and interpret the information in reference to time and market. If farmers have poor understanding of the provided information. The potential gains and increase in trading opportunities might dilute.
- There is market information for the offered products. If there is no information, the opportunities for increasing trade are limited. The MIS generally are focused on certain crops only, because the cost of collecting and updating market data in the field is high.
- Farmers are better off selling any surplus rather than storing it for self-consumption. Agricultural markets are functional and farmers are able to use revenues from crop sales to purchase other products when needed.

Counterviews and their implications

- In SSA, the lack of a standardised system for grading makes it difficult to provide information based on differenced prices. The market information system is inefficient to capture premium prices and farmers do not have incentives to improve quality (KIT & IIRR 2008)
- The human and financial capacity to scale out and scale up the market information systems in SSA is limited and most are not economically viable without continuous funding from donors (Muganga 2011).

Food security consequences

- Market information systems improve smallholders' and traders' ability to decide when and where to buy and sell and increase opportunities to maximise profit and providing opportunities to invest in market information systems.

Project design considerations

- These initiatives are applicable in countries where governments have stopped intervening directly in the markets via marketing boards or parastatal organisations. The policy environment allows farmers and traders to respond to supply and demand signals rather than trading based on centrally defined prices.

Proposition refinement

In a subsequent phase the set of propositions was tested three times in a participatory manner to refine its content and structure during May–June 2013 involving a different set of users and target audiences. This refinement process promoted ownership and ensured that the product was useful and fulfilled the expectations of donors, researchers, practitioners and beneficiaries. Thus, the set of propositions was scrutinised in Canberra from the donor perspective by AusAID managers and senior staff representatives, later examined from the researchers perspective by a group of ACIAR staff involved in food security, and finally presented in Nairobi to a group of African practitioners and experienced researchers working in Africa with positive feedback.

Concluding remarks

A set of propositions for discussion and debate about contentious issues for the design food security projects in SSA was developed, following a consistent methodological approach based on data collected from six major programmes.

The content and structure of the propositions was discussed and examined by a broad community of practice. The aim of these propositions is to provide a platform for discussion

and debate rather than a fixed set of “lessons learnt”. In this regard, they are currently used by CSIRO and AusAID as working tools in new projects aiming to promote social learning in selected topics related to agricultural systems and food security.

References

- Diao X & Hazell P. 2004. Exploring market opportunities for African smallholders. IFPRI Brief 6. "Assuring Food and Nutrition Security in Africa by 2020: Prioritizing Actions, Strengthening Actors, and Facilitating Partnerships," Kampala, Uganda, 1–3 April.
- Karugu W. 2011. Kenya Agricultural Commodity Exchange (KACE): linking small-scale farmers to national and regional markets. Growing Inclusive Markets (GIM) Case Study B068. New York: United Nations Development Programme.
- KIT & IIRR. 2008. *Trading up: building cooperation between farmers and traders in Africa*. Amsterdam: Royal Tropical Institute / Nairobi: International Institute of Rural Reconstruction.
- MLI. 2011. Market Linkages Initiative evaluation report. USAID.
- Muganga A. 2011. The structure, conduct, and performance of agricultural market information systems in sub-Saharan Africa. PhD thesis, Michigan State University.
- Subervie J. 2011. Evaluation of the impact of a Ghanaian mobile-based MIS on the first few users using a quasi-experimental design. INRA. Workshop on African Market Information Systems. Bamako, Mali, 30 Nov–2 Dec.
- Tollens EF. 2006. Market information systems in sub-Saharan Africa: challenges and opportunities. International Association of Agricultural Economists Conference, Gold Coast, Australia, 12–18 August.

Multi-stakeholder innovation processes in African smallholder farming: key lessons and policy recommendations from Benin, Kenya and South Africa

Bernard Triomphe^{1*}, Anne Floquet², Ann Waters-Bayer³, Geoffrey Kamau⁴, Jolanda van den Berg⁵, Brigid Letty⁶, Roch Mongbo², Joe Stevens⁷, Todd Crane⁸, Conny Almekinders⁸, Nour Sellamna⁹, Simplice Davo Vodouhê² and Nicolienne Oudwater³

¹ CIRAD UMR Innovation, Montpellier, France

² Faculté des Sciences agronomiques, Université d'Abomey-Calavi, Cotonou, Bénin

³ ETC Foundation, Leusden, Netherlands

⁴ KARI Headquarters, Nairobi, Kenya

⁵ Agricultural Economics Research Institute, Wageningen University and Research (WUR), Netherlands

⁶ Institute of Natural Resources, Scottsville, South Africa

⁷ Dept of Agric. Economics, Extension & Rural Development, University of Pretoria, South Africa

⁸ Knowledge, Technology and Innovation Group, WUR, Netherlands

⁹ International Centre for development oriented Research in Agriculture, Montpellier, France

* Corresponding author. Email: bernard.triomphe@cirad.fr

Abstract

Within the context of the European-funded JOLISAA FP7 project (JOint Learning in Innovation Systems in African Agriculture), several agricultural innovation experiences focused on smallholders were assessed in Benin, Kenya and South Africa. Fifty-six cases were characterised through review of grey literature and interviews with resource persons according to a common analytical framework inspired by the innovation systems perspective. Of these, 13 were assessed in greater depth through semistructured interviews, focus-group discussions and multistakeholder workshops.

The cases cover a wide diversity of experiences in terms of types, domains, scales, timelines, initiators of innovation and stakeholders involved. Findings indicate that innovation triggers and drivers were multiple. For external stakeholders, likelihood of offering a technological fix to an existing problem and availability of funding were key triggers. For local people, access to input and output markets was a powerful trigger and driver. Market types and dynamics varied greatly. Developing functional value chains and accessing (often erratic) markets proved challenging especially for poorer and weakly organised farmers. Over long periods, many determinants of innovation change dynamically and often unpredictably during the process, including motivations of key stakeholders, triggers, drivers and stakeholder arrangements. The direction of innovation evolves, usually moving from a technology entry point to more organisational or institutional innovation. A recurring challenge for making interventions is whether and how these build on local initiatives and knowledge before engaging in innovation development. Another challenge lies in sustaining innovation processes that have been externally initiated and conducted within a protected environment, once the project stops.

The conclusion is that innovation has to be seen as a continuously evolving bundle of innovations of various kinds, rather than as a pre-planned and usually narrowly defined intervention. Consequently, open-ended, flexible approaches to innovation development are needed with the potential to engage meaningfully over a long time with local stakeholders, so that they take full charge of the innovation process and direction.

Keywords: *analytical framework, approach, intervention, local innovation, timeframe, innovation bundles*

Introduction

While it may not always be recognised outside Africa, agricultural innovation in Africa is highly diverse and dynamic (Sanginga *et al* 2009, Adekunle *et al* 2012). Initiatives involving multiple stakeholders partnering with smallholder farmers to solve problems, increase production and access markets abound, often in the framework of externally funded interventions. There are also many local initiatives and innovations taking place even under harsh ecological and economic conditions. Yet few comparative studies have been conducted so far which attempt to characterise ongoing innovation processes in a systematic way using a common analytical framework (Spielman *et al* 2009).

JOLISAA was an EU-funded research project focusing on assessing multistakeholder innovation processes involving African smallholders. From 2010 to 2013, it identified and assessed a series of cases of smallholder agricultural innovation and rural development in three countries: Benin, Kenya and South Africa. JOLISAA purposefully selected cases in which at least three types of stakeholders had been involved (to go beyond the participatory approaches in which researchers work directly with farmers) and in which the innovation process had lasted at least three years (to go beyond assessing only the initial stage of innovation, such as within the framework of project interventions). JOLISAA was interested in contrasting approaches to innovation: from bottom-up ones with strong input and leadership by farmers and NGOs (usually poorly documented) to more conventional research and development (R&D) led by public (national) research and extension institutions, for which documentation was more common yet not necessarily accessible (Triomphe *et al* 2013). Across cases, JOLISAA sought to understand the trajectory of innovation processes by focusing on the set of stakeholders involved, the sequence of events and phases – planned or frequently unplanned – they went through as innovation unfolded over time, and the triggers and drivers that seemed to explain the dynamics observed.

In this paper, our aim is to discuss major generic issues coming out of the cases JOLISAA assessed, along with some preliminary lessons and recommendations derived from them. Details of several cases are presented elsewhere in these proceedings: see in particular Floquet *et al* (2013a, 2013b); Chengole *et al* (2013a, 2013b) and Kavoi *et al* (2013). The first section gives an overview of the JOLISAA approach to innovation case assessment. The second section highlights the main finding from innovation cases in Benin, Kenya and South Africa. Then a number of challenges met in assessing innovation and lessons learnt about innovation are discussed and recommendations made.

JOLISAA's overall approach to innovation case assessment

JOLISAA used a comparative case study approach to assess innovation processes in three countries with contrasting agricultural and innovation environments. For example, in Kenya, different types of rural economies co-exist including: i) an export sector of high-value products; ii) a sector based on food products processed for urban markets by small- to large-scale formal enterprises that build contractual arrangements with medium-scale and organised small-scale farmers; and iii) a large group of smallholders in arid and semi-arid lands operating under harsh conditions, often in extreme poverty. In the case of Benin, the formal agricultural economy was for decades centred on export crops such as oil palm and cotton. In recent decades, the sprawling urbanisation on the coast has created a large market mainly supplied by an informal economy of small-scale farmers, petty trade and food-processing microenterprises. In South Africa, the dual post-apartheid economy still includes many socio-politically marginalised smallholders mostly disconnected from local or national markets, which are supplied by commercial farmers, and a scarcity of young farmers, as much of the labour force has migrated to the cities and/or sees no future in agriculture.

The three country teams adopted an approach to assessment in four steps conducted primarily in a sequential manner, but with some overlaps:

Step 1: Clarifying concepts and developing an analytical and operational framework.

Key innovation-related concepts such as stakeholders, triggers, drivers, local knowledge and innovation as a process rather than an outcome were defined and agreed on (Almekinders *et al* 2012) and an analytical framework and robust operational guidelines for the inventory and case assessment were developed collectively and iteratively (Triomphe *et al* 2010, 2012).

Step 2: Inventory. In the three countries, only innovations that had gone beyond the small-scale experimentation stage and reached some level of “uptake” by smallholders were selected. The assessment was mainly through available (grey) literature and structured interviews with resource persons. Numerous cases were listed but not documented further, especially in South Africa, because of the lack of (access to) documentation or lack of key informants willing to share information and because getting the information would have been too costly. In the end, an inventory could be completed for 56 innovations over the three countries (27 in Benin, 18 in Kenya and 11 in South Africa). The main focus was on the stakeholders engaged in the process, their functions and what seemed to have happened (main phases) in the unfolding innovation process over time (Triomphe *et al* 2013).

Step 3: Collaborative case assessment. From the inventory, 13 cases (6 in Kenya, 4 in Benin and 3 in South Africa) were selected for collaborative assessment after multiple-criteria ranking by national teams. Collaborative assessment meant inviting local case-specific stakeholders to take part in the investigation at diagnosis and planning steps and in feedback workshops. The case selection criteria included: existence of recent dynamics (to avoid “dead” cases), interest of the local stakeholders to take part in the assessment, and strategic importance of the case at national level. Most of the cases selected were relatively complex processes evolving over one to several decades with a potential to yield valuable lessons (Table 1). The key entry point was either value-chain structuring or natural resource management. The selected cases illustrated a wide range of participation by different stakeholders, e.g. sometimes farmers or researchers were absent or only modestly active; sometimes they took the lead. Semi-structured interviews and focus-group discussions with farmers and other key stakeholders were the main methods used in fieldwork (Triomphe *et al* 2012). A major goal was to reconstruct an innovation storyline; this included triangulating several sources of information about different steps in the process and the stakeholders involved. Interactions between the innovation processes and the wider political, economic and institutional environment in which they were embedded were analysed to identify key triggers and drivers of innovation. Toward the end of the assessment, case-specific local multistakeholder workshops involving farmers, farmer organisations, entrepreneurs, extension workers, NGO staff and researchers were held to validate and clarify the main findings and to identify possible ways forward for the innovation process.

While the approach outlined above was common across the three countries, case selection and assessment had some country-specific traits. In Kenya, it was researchers from regional research stations who screened their regions for suitable innovation cases, in which their institution, if not themselves directly as individuals, had usually been an active stakeholder (Kamau *et al* 2013). The same researchers also headed the six case-assessment teams, in two cases with the assistance of foreign students. Researchers’ strong stake in the assessment process undoubtedly influenced the results JOLISAA obtained in Kenya; it is not easy to take critical distance from one’s own achievements. In Benin, senior university staff engaged in farming systems and innovation studies in agriculture over recent decades did the screening (Floquet *et al* 2012) and then closely supervised the four assessments conducted by teams of young graduates and foreign students. In South Africa, the national team drew heavily on two existing networks (an NGO-led multistakeholder network about local innovation operating in

a few provinces and a national public extension network) to identify cases, while local and foreign students were involved in the three assessments with light supervision in the field.

Step 4: Comparative analysis and formulation of lessons and recommendations. Despite the differences noted above in how the case assessments were done in the three countries, a meaningful cross-analysis was still possible, as common major themes were reported systematically in each case study. After the case assessments were completed, a comparative analysis was made at country level and across Benin, Kenya and South Africa. At both levels, this focused mainly on the role of different stakeholders, especially smallholders, in the innovation process and the nature of linkages developed among them. How the innovation developed, often beyond the initial intention and support of external stakeholders, was scrutinised. At global level, the JOLISAA research team synthesised the results from each country, re-assessed the different cases according to key themes and distilled evidence-based generic lessons and recommendations.

Table 1: Cases selected for collaborative assessment in the JOLISAA project

	Natural resource management	New value chains
South Africa	Infield rainwater-harvesting techniques for field and vegetables crops Soil fertility management experimentation through developing an innovative participatory extension approach	Bulk-buying combined with credit and saving groups
Benin	Integrated soil fertility management for new high value products Indigenous intensification in agrofishing <i>hwedo</i> system through chilli pepper (Floquet <i>et al</i> 2013)	Parboiled rice value chain Soybean food multiple value chains (Floquet <i>et al</i> 2013)
Kenya	Using byproducts for soil rehabilitation and securing access to lime Prosopis management for charcoal and fodder value chains (Chengole <i>et al</i> 2013b)	Aloe sap and gum harvest for processing (Chengole <i>et al</i> 2013a) Gadam sorghum for beer and other processed food (Kavoi <i>et al</i> 2013) Mango production, processing and marketing Solar cooling of milk

Main results

This paper does not describe neither the detailed inventory results, already reported by Triomphe *et al* (2013), nor the national differences in innovation landscapes. Rather, it focuses on four main findings coming out of the cross-analysis of the 13 JOLISAA collaborative cases: i) innovations happen all the time under the radar and may remain largely unrecognised and untapped by formal research and development; ii) innovations are not only – and not even mainly – of a technological nature but include also organisational and institutional changes; iii) as innovation processes conducted by small-scale enterprises tend to give rise to the emergence of a diversity of value chains and markets, they have the potential to ensure resilience and inclusiveness; and iv) over the long term, innovation processes evolve to a complexity that could hardly have been predicted or planned.

For each of these four topics, we present highlights of particularly telling examples chosen from the JOLISAA cases.

1. Invisible or negatively perceived innovation processes “under the radar”

The aloe innovation process in semi-arid Baringo County, Kenya (Chengole *et al* 2013a) shows how difficult it is for public R&D institutions and individuals to take local innovation into account, even when this has strong pre-existing dynamics (Figure 1). Well before the advent of any formal interventions, traders from outside the region led the development of a local aloe supply chain for the export market: local aloe harvesters sold aloe sap to boilers who then supplied traders working with aloe exporters. A series of technical and organisational innovations were developed in this informal value chain (Chengole *et al* 2013a), sometimes as the result of (unintentional) interactions with the activities and proposals of the formal aloe project (see below).

The trigger for the public R&D intervention on aloe (through an EU-funded project) was a perception that wild aloe, an internationally recognised endangered species, was being overexploited, which led to a presidential decree banning its exploitation and sale. An alternative was eventually designed to try and establish a certified, sustainable value chain. Aloe was to be cultivated instead of simply harvested in the wild, a factory for processing aloe sap was to be set up through a public-private partnership, and the processed sap would be exported legally so that the value added would eventually support aloe conservation and provide a sustainable source of livelihood to poor aloe farmers.

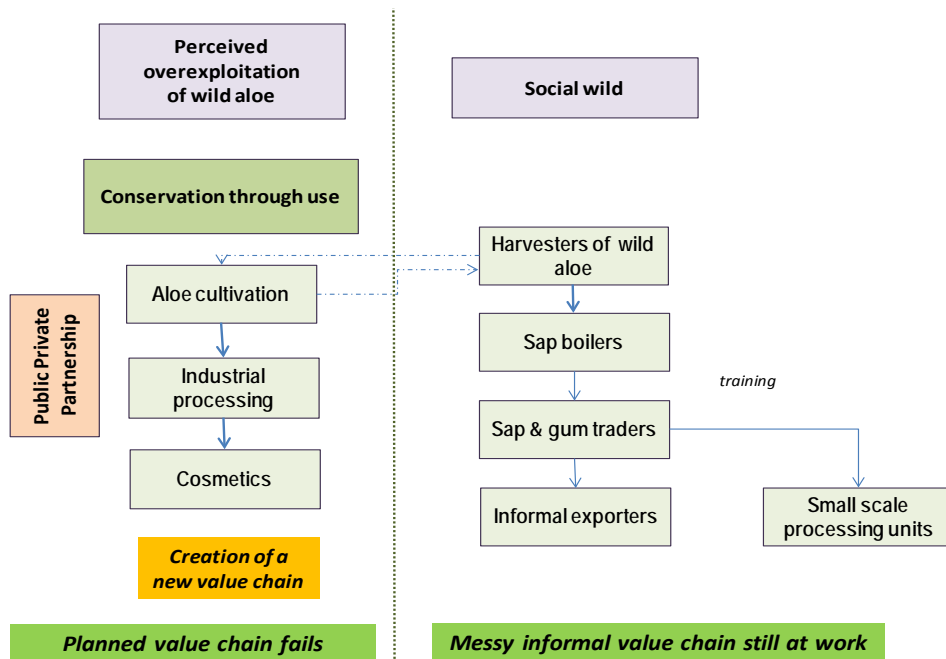

Figure 1: Two parallel value chains for processing aloe: formal and informal

When this project was designed, no attention was given to the existing local processing and marketing system: indeed, the public R&D actors deliberately ignored this system, as they perceived it as having a negative impact on aloe sustainability. Also, it relied on actors (the sap traders, women) with a low social status and capital. Thus, interests of the local stakeholders were not considered in project design and operation. As a consequence, the actual implementation of this apparently well-thought-through concept went through many delays, challenges and conflicts among stakeholders, which prevented it from reaching the stated objectives.

Other JOLISAA cases illustrate the same trend of no or limited attention to local innovation, even when it has been well established for a long time or when it exhibits a very dynamic and

successful adaptation to a rapidly changing environment; this is particularly true for the innovation related to fishponds in floodplains of southern Benin (Floquet *et al* 2013c).

2. Closely linked technological, organisational and institutional innovation

The prosopis case in Baringo (Chengole *et al* 2013b) illustrates how technical innovation induces a sequence of organisational and institutional innovation (Figure 2).

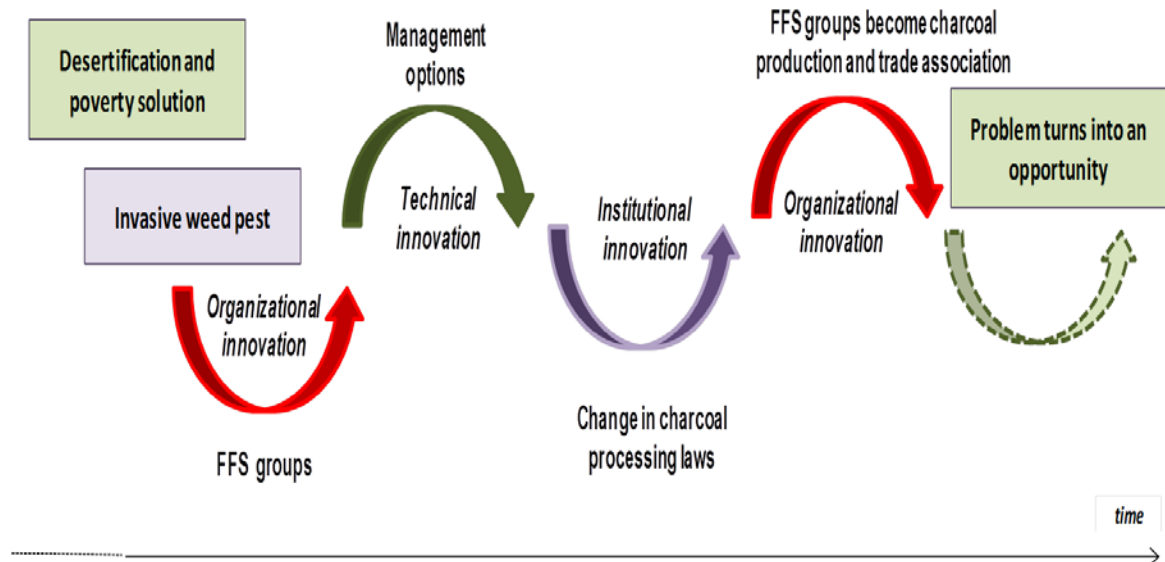

Figure 2: Sequencing of technical, organisational and institutional innovation in the prosopis case in Kenya

Prosopis had been introduced as the miracle plant that would save arid lands in Kenya from desertification and poverty. What could be called a simple and isolated technical innovation, however, became an invasive species and was rapidly perceived as a noxious weed by local communities, who called for its eradication. As an alternative, a number of public R&D stakeholders set up an organisational innovation in the form of Farmer Field Schools (FFSs), where community members were exposed to a set of technical innovations for managing the tree to keep it under control, including how to produce charcoal from prosopis. Charcoal making and trade were, however, considered illegal. Therefore, charcoal-making rules had to be changed, thus introducing an institutional innovation to allow controlled and traceable charcoal production and trade based on prosopis. This change made it possible for some of the FFS groups to specialise in charcoal production and trade as a way of controlling prosopis, thus raising their income and leading to a positive perception of charcoal burning, which had previously been regarded as an activity with low social status. Other benefits consisted of producing high-quality honey from prosopis stands and using prosopis pods as a new source of feed for local livestock. Recently, prospects for using prosopis biomass to generate electricity locally have emerged.

While the prosopis case is certainly not an example of local innovation, nor can it be seen as a unambiguous “success story”, it illustrates well that a sequence of technological, organisational and institutional innovations, including the vital linkage with the charcoal market, allowed the process to take root and offered improved opportunities for local communities. This stands in sharp contrast to the conventional (and still commonplace) R&D interventions that focus on purely technological change and never manage to land properly in the local landscape.

3. Diverse value chains and markets for resilience and inclusiveness

Innovation studies and interventions commonly focus on modern formal value chains, especially those giving access to lucrative export markets or based on large-scale processing units. But there are other possibilities of working with value chains: the soybean case in Benin (Floquet *et al* 2013a) shows how diversification of processing and marketing options for a commodity offers flexibility, adaptability and profit to smallholder producers, small-scale processors and poor rural and urban consumers (Figure 3).

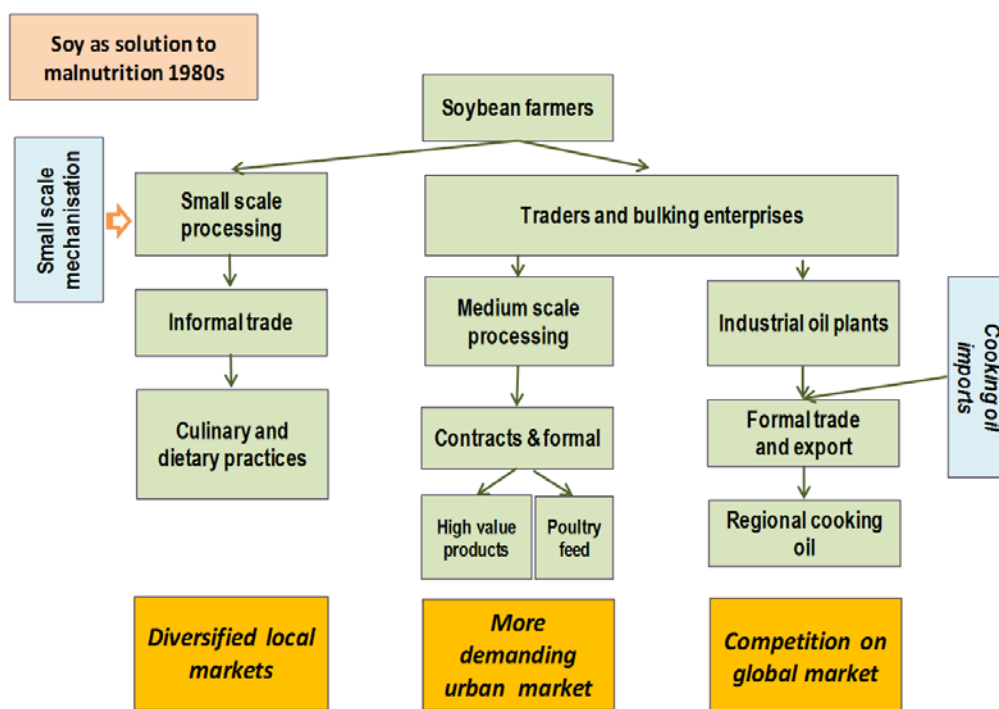

Figure 3: Emergence of a diversified set of value chains in the soy case in Benin

Soybean was introduced in the 1980s to improve infant nutrition via a protein-rich formula and was cultivated, if at all, only on small plots for consumption: It has now become a major crop on more than 100,000 ha. Two main groups of stakeholders are behind this phenomenon:

- i. Thousands of very small-scale female processors of food with very rich knowledge of local cuisine gradually developed a range of food products out of the introduced soybean and information about how to toast it. They used soy as an inexpensive substitute for food products traditionally made with cow cheese, locust bean, meat etc. With the help of some NGOs, several value chains emerged around soy-based food products targeting local and then urban consumers eager to find cheaper alternatives to meat- and fish-based products, especially in recent years of acute crisis linked to higher food prices. Small-scale processing allows for gradual upgrading and asset acquisition by these female-operated microenterprises, which can go from having no equipment to renting milling services, and from renting services to owning equipment.
- ii. Industrial oil factories started looking for soybean when their supply of cottonseed was dwindling: such massive demand sped up the introduction of soy into smallholder farming systems. Development projects also funded the emergence of medium-scale value chains for animal feeds, semi-industrial oil and baby food by supporting intermediate enterprises that would link soy producers and processors.

The emergence of an industry-led value chain brings challenges. For one, since it competes with cheap oil imports from global markets, it puts a downward pressure on the price at

which it buys soybean. Above all, it is a source of insecurity for smallholders because the demand for soybean by oil factories varies from one year to the next, depending on relative prices of soybean and cottonseed. Soybean producer organisations (POs) find it difficult to develop contractual arrangements with an industry ready at any time to source its supply elsewhere. In response, some POs are seeking alternative markets, such as poultry keepers and small-scale feed industries. The dynamics of these emerging value chains and arrangements are still very strong with respect to cooperation of stakeholders involved in the soy value chain, contractual arrangements and improvements in soybean-production techniques.

For smallholder farmers, the existence of parallel value chains seems to be an asset: they may opt to diversify their production systems, do not depend on only one large-scale purchaser and have the opportunity to adjust gradually to an increase in quality and quantity requirements of the purchasers (consumers). It is also an asset for many poorer consumers, who can access some high-quality food at affordable prices. Thus, not betting exclusively on one formal value chain (as so many project interventions do) may help to increase resilience and inclusiveness, for the benefit of many resource-poor stakeholders, be they farmers, processors or consumers.

4. Unpredictable outcomes of innovation processes

As one innovation induces another, bundles of interlinked innovations unfold. Over time, innovation processes evolve to a complexity that could hardly have been predicted or planned. In the soy case in Benin, the initial project only wanted to convince mothers to integrate soy into infant food to reduce infant mortality rates. It neither envisioned nor anticipated that this would become the starting point for the emergence over a 30-year period of the many small-scale value chains discussed above, or give impetus to growing soy on smallholder farms or to oil factories sourcing soybean as an alternative to cottonseed (Figure 3). Similar observations could be made on other cases documented by JOLISAA such as the prosopis or aloe cases in Kenya mentioned earlier.

Such long timelines and unplanned innovation trajectories typically escape the attention and capacity of externally driven interventions, which tend to focus on early stages of innovation and usually have no mechanisms or resources to deal with unplanned or later changes beyond project frames. These also go undocumented by people assessing the effects of the interventions. Taking a long-term view is essential for the eventual success of innovation: long timeframes allow innovation to take root, to diversify out of a usually narrow initial focus and to have measurable impact.

Key recommendations for research, policy and practice

We now focus on a few key lessons and recommendations for research, policy and practice related to supporting innovation processes and stakeholders coming out of the evidence uncovered during the JOLISAA work described above.

Recognise and support existing local innovation processes

Many innovations occur in the “social wild” (Sherwood *et al* 2012), also when there is no or no longer any externally driven public R&D intervention. Innovation often takes unforeseen directions after short-term interventions are over, or even during them. In agreement with conclusions reached in Sanginga *et al* (2009) and the Research Into Use (RIU) programme (Sulaiman *et al* 2011), we propose that policymakers, researchers and practitioners should do their utmost to recognise and strengthen existing local innovation processes, rather than ignoring them altogether or trying to replace them.

Chances of success and scaling up would then increase, as interventions would benefit from an already socially well-rooted process among local stakeholders rather than trying to induce

it from scratch, an uncertain and slow enterprise. Adequate documentation of existing practice and innovation is a necessary starting point before intervention. Public R&D organisations might want to invest in long-term monitoring of a range of strategic situations and environments to draw a comprehensive and up-to-date picture of selected ongoing innovation processes. A change of attitude may also be needed, so that any external documenters acquire a more positive view of local innovation and local knowledge; this may require changes in the entire agricultural educational, research and extension system.

Approach innovation in its various dimensions

A major lesson derived from analysing the JOLISAA case studies, highlighted also by other authors (Hall *et al* 2010, Kilelu *et al* 2013) and the RIU programme (Sulaiman *et al* 2011), is that the various dimensions of innovation (technological, institutional and organisational) co-evolve, i.e. interplay and complement each other, along an innovation trajectory, without one dimension being more important than the other. A well thought-through sequencing of these different types of innovations is important in contributing to the eventual success and scaling up of innovation. This goes counter to commonly held views of biophysical researchers and other professionals, who tend to give priority to technological innovation, or business-oriented professionals who put a premium on managerial and organisational innovation.

To take this lesson on board, a broad conception of innovation bundles (rather than individual innovations) should be ensured right from the beginning of an intervention, including its diagnostic phase. Time should be taken for considering carefully and flexibly the sequencing of innovations of various types as the innovation process unfolds. To improve the process, periodically assessing it with the relevant stakeholders to identify missing or needed types of innovation, or to decide collectively on the proper timing for addressing technical or organisational or institutional changes, should be an integral part of sound approaches to monitoring and supporting innovation.

Accompany innovation in a flexible, open-ended manner over the long term

Several JOLISAA cases (soybean in Benin, prosopis in Kenya) illustrate that innovation trajectories extend in unpredictable ways over the long term. What may have seemed the “right” way to go at one moment in time may reveal itself to be premature or a dead end or not possible within a given environment, or it may create unexpected new problems (see prosopis case). New stakeholders emerge or intervene. Possibilities and conditions that were never dreamed of materialise and spur a new cycle of innovation or allow fast uptake of a, until then, dormant innovation.

Intervention projects frequently lack the proper instruments for dealing effectively with the unpredictability of social change. On the basis of our JOLISAA cases, we recommend that interventions should adopt an open-ended approach to planning their activities, rather than a rigid logframe-type approach in which an intervention team designs activities covering several years. This would obviously require the donors’ commitment and adapted modalities for funding. Long-term involvement in and support to innovation should be negotiated or at least anticipated from the start, rather than adhering uncritically to the logic of short-term funding cycles. This may mean identifying a portfolio of donors rather than depending on one donor (to bridge several project cycles and opportunities) and also planning interventions and support (including brokering mechanisms or organisations) that do not rely excessively on external funding for their implementation but rather on commitments and institutional mechanisms put in place by national governments. This may also imply relying much more on the initiatives and resources of local stakeholders.

Discussion and future directions

JOLISAA focused on assessing a wide range of innovation processes in a mostly *ex-post* mode. In doing so, we came upon lessons and recommendations that have to do with how best to identify and support innovation processes through public R&D.

The value and challenges of documenting and monitoring innovation

As innovation processes “in the social wild” are poorly or only partly understood, recognised or documented, it is difficult to build upon them to strengthen existing innovation dynamics. Hence, a set of key questions need to be answered: How can local innovation be more systematically documented and assessed? Who would be willing to invest in such a low-profile and low-prestige activity that may not herald any central role of public R&D actors in steering innovation nor correspond to their agenda? What are the best (participatory) methods and tools for documenting and assessing such dynamics and ways to support them effectively? And who should document?

Supporting ongoing innovation processes and overcoming the project culture

While documentation and assessment is a necessary first step, it is not enough. Supporting ongoing innovation processes remains a challenge. Often, public R&D institutions, NGOs and governments mandated to support development and innovation have their own agenda, limitations and weaknesses, which put them in a difficult position to offer effective support.

A major stumbling block in sub-Saharan Africa is the prevalence of a “project culture” in which decisions and activities are biased toward short-term operationalisation of donors’ priorities and fashions, and which is not or only weakly accountable to the intended beneficiaries and actors in development, i.e. local people and organisations. Overcoming the limitations and pitfalls of the project culture is hence a major need and challenge which needs to be tackled as such, if more effective support to innovation is to be offered.

Who should be in the driver seat of innovation processes?

JOLISAA has found it difficult to identify and document innovation processes in which farmers and other local people were in the driving seat. Is it simply an unlucky bias in our sample of cases or in our approach, or does it reflect a more general bias? Several international initiatives have focused on recognising local innovation and given local people a much bigger say in deciding where to invest their efforts in developing innovations (e.g. Waters-Bayer *et al* 2011). The question however remains: What is the optimum blend between local and external initiative? Local knowledge and visions have certainly a lot to gain from scientific and other type of codified knowledge and initiatives, and vice versa, so as to be able to address emerging challenges and grasp new opportunities. The increasingly popular innovation platforms, allowing different stakeholders to share their knowledge and vision and to join forces in designing alternatives, might be one way to go (Nederlof *et al* 2011). However, forming and facilitating such platforms so as to give “enough” voice and power to the weaker stakeholders remains a challenge.

Gaining the necessary capacity to support innovation processes

Behind many of the challenges mentioned until now, the issue of innovation capacity is almost always present. Innovation capacity is needed in many dimensions and for many types of actors. For example, most professional staff from R&D institutions usually lack a proper and deep-enough understanding of innovation-related concepts and processes, be it for assessing or supporting them, perhaps partly because there are too few staff trained in social sciences. Other key actors would also benefit from strengthened innovation capacity in terms of understanding the innovation landscape, building interactions with each other or taking into account the multiple dimensions of innovation. While experiential learning is an

essential and effective way of acquiring it, it should ideally be complemented with more formal efforts at building capacity, including through offering to all stakeholders well-designed residential workshops focused on exchanging experiences and reflective analysis.

Conclusions

By assessing a series of case studies about innovation processes and experiences involving African smallholder farmers, JOLISAA was able to understand better the nature of innovation. In short, innovation is a complex, multifaceted and dynamic process involving multiple and changing stakeholders, interacting intimately with its environment, evolving over long periods and unfolding in directions impossible to devise from the start. Hence, it does not lend itself easily to the rather simple and short-term strategies, approaches and projects usually devised by R&D institutions to spur it. These frequently ignore local realities and dynamics as a foundation on which hybrid innovation, combining the ideas and resources of local and external actors, may take lasting root.

How can R&D actors, governments and donors learn from our assessment and similar initiatives to better support innovation and stakeholders and thus contribute to improve the livelihoods of smallholder farmers and processors and other rural or urban dwellers? JOLISAA has come up with a set of evidence-based recommendations, which can be further improved to become even more concrete and convincing. A major one is to pay due attention to local innovation dynamics and to build on them over long periods of time. But implementing such recommendations requires not only access to resources and strengthened capacities and skills, but a fundamental shift in the attitudes and practices of researchers, advisors, practitioners and the donor community alike, undoubtedly not a simple undertaking.

References

- Adekunle AA, Ellis-Jones J, Ajibefun I, Nyikal RA, Bangali S, Fatunbi O & Ange A. 2012. Agricultural innovation in sub-Saharan Africa: experiences from multiple-stakeholder approaches. Accra: Forum for Agricultural Research in Africa (FARA). (www.fara-africa.org/media/uploads/library/docs/fara_publications/agrl_innovations_in_ssa.pdf).
- Almekinders C, Crane TA, Harms B, Berg J van den & Fagbemissi R. 2012. A review of IS theories and approaches and their significance for agricultural/rural innovation in small-scale farming in Africa. Wageningen: WUR / Montpellier: CIRAD.
- Berg J van den, Harms B, Sellamna N, Triomphe B & Vodouhê DS. 2011. JOLISAA approach to joint learning in agricultural innovation research: interplay between knowledge building, networking and capacity building. JOLISAA Working Paper. Wageningen: WUR.
- Chengole JM, Belmin R, Welimo M, Kamau G & Triomphe B. 2013a. Experiences with aloe domestication and exploitation, Baringo County, Kenya. In: Triomphe B et al (eds), *Innovation in smallholder farming in Africa: recent advances and recommendations* (Montpellier: CIRAD), pp72–75.
- Chengole JM, Welimo M, Belmin R, Ng'ang'a T & Kamau G. 2013b. From a desired to a despised and later desired tree: the case of prosopis introduction and management in Marigat, Baringo County, Kenya. In: Triomphe B. et al. (eds), *Innovation in smallholder farming in Africa: recent advances and recommendations* (Montpellier: CIRAD), pp76–79.
- Floquet A (ed.). 2012. National inventory report: Benin. Cotonou: Faculté des Sciences Agronomiques, Université d'Abomey-Calavi.
- Floquet A, Vodouhê G, Michaud A, Bridier B & Vodouhê SD. 2013a. How innovation processes unfold along unexpected trajectories: the case of soy in Benin. In: Triomphe B, et al. (eds), *Innovation in smallholder farming in Africa: recent advances and recommendations* (Montpellier: CIRAD), pp105–110.
- Floquet A, Mongbo R, Vodouhê G & Houédokoho F. 2013b. No see, no hear, no talk – three-monkeys fable in the ARD triangle: the agrofishing “hwedo” system of the Ouémé floodplain (Bénin). In: Triomphe B et al (eds), *Innovation in smallholder farming in Africa: recent advances and recommendations* (Montpellier: CIRAD), pp91–95.

- Floquet A, Vodouhê SD, Berg J van den, Tossou CR, Triomphe B & Mongbo R. 2013d. Models in innovation studies: a critical reflection based on comparison of four innovation processes in Benin. In: Triomphe B. et al. (eds), *Innovation in smallholder farming in Africa: recent advances and recommendations* (Montpellier: CIRAD), pp96–104.
- Hall A & Clark N. 2010. What do complex adaptive systems look like and what are the implications for innovation policy? *Journal of International Development* 22 (3): 308–324.
- Hall A, Janssen W, Pehu E & Rajalhati R. 2006. *Enhancing agricultural innovation: how to go beyond the strengthening of research systems*. Washington DC: World Bank.
- Kamau G, Ng'ang'a T & Kirigua V. 2012. 18 inventory short cases in Kenya. Nairobi: KARI (www.jolisaa.net/index.php/projets/content/download/11683/69989/file/Compilation%2018%20inventory%20cases%20kenya%20final%20version%20April%202012.pdf).
- Kavoi JM, Kamau G, Kisilu R, Wafula J & Ng'ang'a T. 2013. Innovation in gadam sorghum production and marketing in Eastern Kenya. In: Triomphe B. et al. (eds), *Innovation in smallholder farming in Africa: recent advances and recommendations* (Montpellier: CIRAD), pp127–129.
- Kilelu C, Klerkx L & Leeuwis C. 2013. Unraveling the role of innovation platforms in supporting co-evolution of innovation: contributions and tensions in a smallholder dairy development programme. *Agricultural Systems* 118: 65–77.
- Letty B & Stevens J. 2012. National inventory report: South Africa. Pretoria: University of Pretoria.
- Nederlof S, Wongtschowski M & Lee F van der. 2011. *Putting heads together: agricultural innovation platforms in practice*. Amsterdam: Royal Tropical Institute (KIT).
- Sanginga P, Waters-Bayer A, Kaaria S, Njuki J & Wettasinha C (eds). 2009. *Innovation Africa: enriching farmers' livelihoods*. London: Earthscan.
- Sherwood SC, Schut M & Leeuwis C. 2012. Learning in the social wild: encounters between Farmer Field Schools and agricultural science and development in Ecuador. In: Ojha HR, Hall A & Sulaiman R (eds), *Adaptive collaborative approaches in natural resources governance: rethinking participation, learning and innovation* (London: Routledge), pp102–137.
- Spielman DJ, Ekboir J & Davis K. 2009. The art and science of innovation systems inquiry: applications to sub-Saharan African agriculture. *Technology in Society* 31 (4): 399–405.
- Sulaiman RV, Hall A & Reddy VTS. 2011. Missing the target: lessons from enabling innovation in South Asia. Wallingford, UK (www.dfid.gov.uk/r4d/PDF/Outputs/ResearchIntoUse/riu11discuss25asia.pdf).
- Triomphe B, Crane T, Almekinders C, Harms B & Fagbemissi R. 2010. Guidelines for the inventory of innovation cases. JOLISAA internal project document. Montpellier: CIRAD.
- Triomphe B, Berg J van den, Kamau G, Floquet A, Letty B & Bridier B. 2012. JOLISAA approach and guidelines to collaborative case assessment. JOLISAA project document. Montpellier: CIRAD.
- Triomphe B, Floquet A, Kamau G, Letty B, Vodouhê SD, Ng'ang'a T, Stevens JB, Berg J van den, Sellamna N, Bridier B, Crane T, Almekinders C, Waters-Bayer A & Hocdé H. 2013. What does an inventory of recent innovation experiences tell us about agricultural innovation in Africa? *Journal of Agricultural Education and Extension* 19 (3): 311–324.
- Waters-Bayer A *et al.* 2011. Farmer-managed innovation funds drive multi-stakeholder learning processes. CTA/GFRAS International Conference Innovations in Extension and Advisory Services, Nairobi, Kenya, 15–18 Nov.
- Zoundi SJ & Hitimana L. 2011. The challenges facing West African family farms in accessing agricultural innovations: institutional and political implications. In: Batiano A *et al* (eds), *Innovations as key to the Green Revolution in Africa* (New York: Springer), pp49–62.

The JOLISAA project was funded under European Commission FP7 Grant Agreement 245319. The opinions expressed herein are the sole responsibility of JOLISAA. More information on JOLISAA can be found at www.jolisaa.net

SECTION 3: SHORT PAPERS

Supporting farmers with funds for innovation: the Ghanaian experience

Franklin K Avornyo^{1*}, J Lambon², J Nchor², M Alebikiya², JM Kombiok³ and B Alenyorege⁴

¹ Council for Scientific and Industrial Research (CSIR) Animal Research Institute, Nyankpala, Ghana

² Association of Church Development Projects, Tamale, Ghana

³ CSIR Savanna Agricultural Research Institute, Nyankpala, Ghana

⁴ University for Development Studies, Nyankpala, Ghana

* Corresponding author. Email: favornyo@yahoo.com

Abstract

The Farmer Access to Innovation Resources (FAIR) project investigated how funds given to farmer innovators could facilitate their experimentation and rural development in Northern Ghana. The fund was piloted in four zones. Farmers were sensitised on the operation of the fund. Farmers' applications were vetted by management committees of 8–10 members comprising development workers and farmers, and the best innovations were funded. In total, 270 men and 151 women farmers benefited over a period of four years. Adoption rate of the innovations by other community members ranged from 25 to 59%. The innovators indicated they were becoming more food secure and their incomes were increasing. After three years of operation, more interesting proposals were emerging. Some farmers sometimes felt funds came late. Illiterate farmers were having difficulty following the concept. Another challenge was getting more women to benefit from the fund. The innovation fund did not yet become truly farmer-led during the project period (2008–12), although that was the intention. The approach adopted in Ghana was to build up farmers' capacity gradually to be able to manage the fund well on their own.

Keywords: *innovation funds, experimentation, smallholder farmers, women, environment*

Introduction

Farmers are constantly experimenting and trying to improve upon their farming business (Veldhuizen *et al* 1997, Wettasinha *et al* 2010). The conventional approach to funding agricultural research makes the researcher the custodian of the research funds and the research agenda is often set without the active involvement of the farmer. The end result is that farmers' uptake of conventional researcher-generated technologies is often very low. Alternatively, farmer innovators can be identified and given funds to develop and spread innovations relevant to their business. This approach was borne out of the notion to empower farmers to set and control the research agenda. The main aim of the project was to understand how a Local Innovation Support Fund (LISF) could catalyse the development and spread of farmer innovations and become a sustainable funding mechanism for stimulating farmer innovation.

Materials and methods

Figure 1 describes the overall process followed. It began by visiting communities to sensitise them on the fund (PROLINNOVA 2012, Avornyo *et al* 2012b). Interested farmers collected application forms to fill in. The completed applications were submitted to a management committee and were vetted. The best innovations were funded and their implementation was monitored, evaluated and documented and the results were disseminated. The fund was

piloted in Yendi, Tamale, Bolgatanga and Walewale Zones, each with a management committee comprising development workers and farmers (PROLINNOVA 2012, Avornyo *et al* 2012b). A tool called the Register was used to keep track of applications to the fund. An impact assessment guideline was used to assess the impact of the project on community livelihoods after four years of project implementation. Two communities each from Bolgatanga and Tamale zones were visited for the impact assessment. This was in the form of focus-group discussions (FGDs) with purposively identified groups. In each zone, there were separate FGDs with representatives of partner institutions and then an FGD with the Fund Management Committee. In each community, there were three separate FGDs: one with five successful innovators, one with five unsuccessful innovators and finally one with five local-authority members. Matrix scoring was one of the tools used to assess the extent of project impact. Adoption rate was measured as number of households in the community adopting an innovation over the project period.

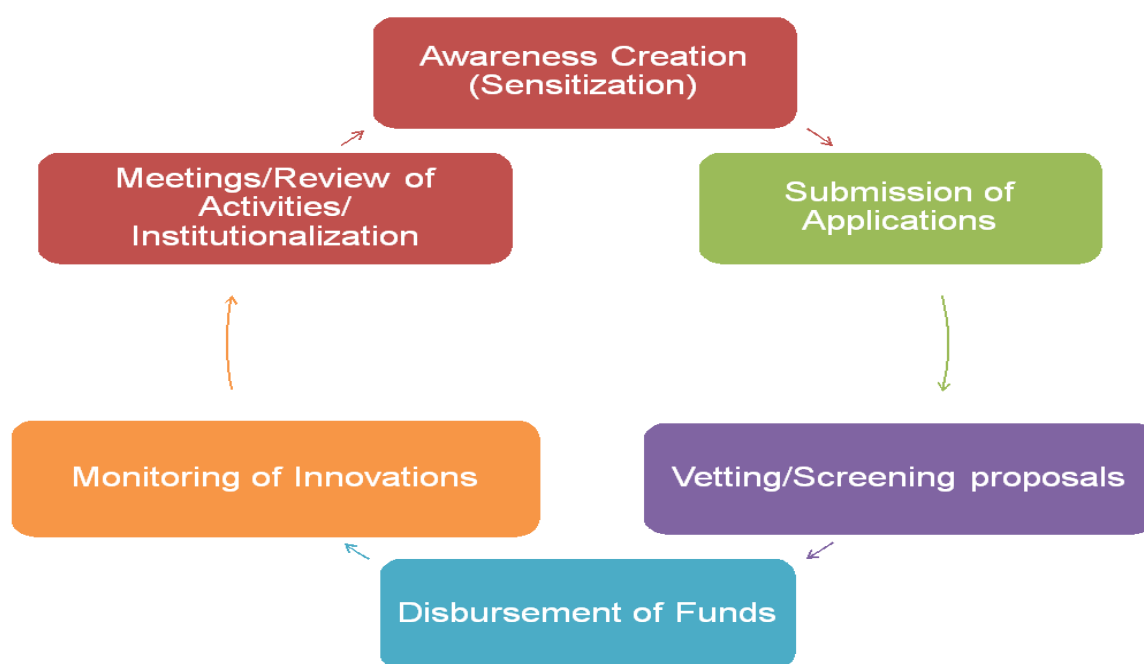

Figure 1: The process followed for implementing a Local Innovation Support Fund

Results and discussion

In all, 270 men and 151 women farmers benefited from the fund over a period of four years. The LISF approach was effective, as adoption rates of farmers’ innovations (25–59%) were high. Farmer innovators could better feed their families, pay school fees, diversify into microenterprises, pay health insurance, acquire property and buy farm inputs. After three years, the percentage of proposals that were successful in received funding had increased.

Table 1: Functioning of the LISF process

Parameter	Bolgatanga	Walewale	Tamale	Yendi
Average time from application to screening	65 days	41 days	160 days	30 days
Percentage of reports received in time	79	7	29	83
Average delay of delayed reports	151 days	10 days	16 days	18 days

In some participating communities, pressure on use of natural resources as alternative sources of livelihood reduced after a local innovation that increased onion productivity spread. This was found out during the process of matrix scoring in FGDs. Most innovators were willing to

share their innovations; this is one benefit of multistakeholder partnerships (Ssuuna *et al* 2012). Farmer innovators and their households received recognition by community members and development workers (Figure 2). Like in Kenya (Ssuuna *et al* 2012), it was found that linking innovators to relevant stakeholders was a source of motivation for the farmers to innovate. Community members started organising themselves into experimenting groups, improving transparency, unity and the interest to innovate. They shared lessons learnt. They and development partners became more open to each other, and information flow had reached neighbouring communities.



Figure 2: Innovator receiving award at National Farmers' Day celebration

Challenges

Sometimes funds for farmers came late. Illiterate farmers found it more difficult to understand the fund concept and the application forms. Another challenge was about getting more women to benefit from the fund. Women's proposals were about microenterprises, outside the scope of the fund. Maintenance of good governance of the funds by community leaders was also yet to be achieved.

Conclusions and recommendations

The fund as piloted in Ghana was not completely farmer-led because project managers wanted a gradual transition to build farmers' capacity to manage the fund well. However, adoption rates of innovations supported by the LISF were high. Farmer innovators reported that their households became more food secure and had more money to spend. There was less dependence on the natural forest resources for their livelihood. Relevant innovations appear to exist in the communities. However, the benefits of the LISF appeared to be skewed to the men.

Local innovations, especially those that address issues of poverty and the environment, should be identified, developed and disseminated. With literacy training, farmers stand a better chance of understanding the LISF concept and increasing their knowledge of other innovations (Veldhuizen *et al* 2011). Women farmers need more targeting to identify female innovators, as was done in Ethiopia (Wettasinha *et al* 2008). Their interest needs to be represented in the Fund Management Committees (Avornyo *et al* 2012a). Innovations need to be validated scientifically with the full collaboration of the innovators.

References

- Avorny F, Alhassan Z & Nchor J. 2012a. Ghana Local Innovation Support Fund (LISF) model and upscaling scenarios. Tamale: PROLINNOVA–North Ghana.
- Avorny FK, Lambon L, Nchor J & Alenyorege B. 2012b. Action research on Farmer Access to Innovation Resources (FAIR): Ghana's experience. Tamale: PROLINNOVA–North Ghana.
- PROLINNOVA. 2012. Farmer Access to Innovation Resources: findings and lessons learnt on facilitating Local Innovation Support Funds. Leusden: PROLINNOVA International Secretariat, ETC Foundation.
- Ssuuna J, Gonsalves J & Veldhuizen L van (eds). 2012. *Making partnerships work: insights from PROLINNOVA's work in three countries in Africa*. Silang, Cavite, Philippines: IIRR / Leusden: PROLINNOVA International Secretariat, ETC Foundation.
- Veldhuizen L van, Waters-Bayer A & de Zeeuw H. 1997. *Developing technology with farmers: a trainer's guide for participatory learning*. London: Zed Books / ETC Foundation.
- Veldhuizen L van, Waters-Bayer A, Wettasinha C & Hiemstra W (eds). 2011. *Farmer-led documentation: learning from PROLINNOVA experiences*. Silang: IIRR / Leusden: PROLINNOVA International Secretariat, ETC Foundation.
- Wettasinha C & Waters-Bayer A (eds). 2010. *Farmer-led joint research: experiences of PROLINNOVA partners*. Silang: IIRR / Leusden: PROLINNOVA International Secretariat, ETC Foundation.
- Wettasinha C, Wongtschowski M & Waters-Bayer A (eds). 2008. *Recognising local innovation: experiences of PROLINNOVA partners*. Silang: IIRR / Leusden: PROLINNOVA International Secretariat, ETC Foundation.

Acknowledgements

We thank the Rockefeller Foundation and the Netherlands Directorate for International Cooperation (DGIS) for providing funds. The Association of Church Development Projects (ACDEP) and the Northern Ghana LEISA Working Group (NGLWG) members provided managerial and technical support for this work to be done. We are also very grateful to Laurens van Veldhuizen and Ann Waters-Bayer for providing technical backstopping.

Facilitating agricultural innovation: example from Agricultural Innovation Grant Scheme (AIGS) in Papua New Guinea

Tesfaye Beshah^{1*}, Adiel Mbabu² and Andy Hall³

¹ Intergovernmental Authority on Development (IGAD), Djibouti

² International Potato Centre (CIP), Nairobi, Kenya

³ LinK Ltd, UNU-MERIT and Open University, UK

* Corresponding author. Email: btesfaye2003@yahoo.com

Note: This paper was extracted from Chapter 9 of the book “Capacity building for agricultural research for development: lessons from practice in Papua New Guinea” (Mbabu & Hall 2012).

Abstract

The work presented here is based on a five-year project that pursued a holistic capacity-building initiative in Papua New Guinea supported by AusAID. The initiative was called Agricultural Research and Development Support Facility (www.ardsf.nari.org.pg). This work was inspired by the innovation systems perspective and its offshoot – Agricultural Research for Development (AR4D) – even though it was not explicitly required in the design. The design pitched a high-level goal – improved food security and increased incomes among smallholder agricultural producers – and provided Component 1 to build capacity for the national agricultural research institute, Component 2 to build capacity for five research and extension organisations and Component 3 to pilot an agricultural innovation grant scheme (AIGS). The three components were expected to synergistically interact to more effectively contribute to the overall goal. The AIGS promoted innovation along respective value chains. These included technological, organisational, institutional and policy innovations, consequently leading to increased productivity, access to lucrative local and international markets, increased incomes and associated improved livelihoods.

These achievements were, however, made against great challenges, especially during the first two years of project implementation. These included the lack of a common understanding of innovation and how innovation systems operate. This was largely due to the entrenched legacy of previous development approaches highly oriented towards compartmentalised capacity-development approaches. The traditional approaches also did not sufficiently emphasise collective learning, which is central to innovation systems thinking. Consequently, it took about a year and a half to introduce innovation systems thinking and practice among the key leadership and associated stakeholders.

Some of the key lessons drawn from this work were: i) the need for flexibility during implementation to provide adequate opportunities for all key stakeholders to fully understand the idea of innovation and how to achieve impact of people’s livelihoods through learning-by-doing; ii) the importance of having a clearly articulated purpose of the scheme that specifies how it will impact on the livelihoods of smallholders; iii) the importance of scoping each successive funding call to ensure links with the purpose; iv) creating institutional arrangements that ensure ownership of the scheme with continuous capacity development; and v) the need to balance pressure from the donors to spend project money in a stipulated time with the need to facilitate necessary learning for innovation.

Keywords: *innovation, innovation systems, grant scheme, capacity building*

Introduction

This paper describes the development and implementation of an agricultural innovation grant scheme (AIGS) as part of a capacity-building process framed by Agricultural Research for Development (AR4D). The grant scheme was critical to the capacity-building process in the

national research and extension systems in Papua New Guinea (PNG), where it provided resources for agricultural research organisations to work in a new way as part of wider development activities. The development of the scheme illustrates the way its protocols were iteratively developed through a series of four grant calls. This helped finetune the targeting of the scheme towards innovation projects that had development relevance and made the most of research as well as developmental expertise of the partners involved. The success of the scheme has made it a potential candidate for scaling up as a national competitive grant scheme.

Key principles of funding innovation in AR4D

Innovation systems perspectives and the AR4D approach demand new types of projects that support innovation as the key means of generating sustainable social and economic benefits. This involves projects that combine research and development activities and that place strong emphasis on adding value to emerging opportunities. Projects may also tackle constraints in the innovation process – technical, institutional or policy bottlenecks – but this is done with a view to promoting innovation of social and economic significance rather than as an end in itself. As stated above, innovation-oriented projects should result in social and economic benefits at various levels, more importantly at local level. Therefore, the basis of funding this type of project is different from the way research and extension activities are normally funded.

With few exceptions, where participatory research and extension systems were introduced, funding for major agricultural research organisations was through either competitive or core support. The purpose of research organisations was conceived as generating new information and developing new technologies in response to different agricultural development constraints. Agricultural extension activities were then used to promote research-driven information and technology¹⁰. This research-extension linkage model focused more on technological innovation and less on associated institutional and policy innovations, consequently limiting potential adoption of the technology among resource-poor smallholder farmers.

Features of innovation projects

An innovation project is different from both a research project and extension services in a number of respects. Key features extracted from 31 successfully implemented innovation projects under the Agricultural Research and Development Support Facility (ARDSF) in PNG are summarised below.

- The primary focus of innovation projects is not on conducting research, but on finding ways that research products and expertise can be used productively for social and economic benefits.
- The purpose is not just to transfer technologies, but to couple access to technology and expertise with access to markets, credit and other inputs and to create the institutional arrangements that make these links responsive to the needs of stakeholders in the innovation processes.
- The scope of such projects can go beyond agriculture and include related issues in education, health, energy, commerce and industry and financial sectors.
- Different types of organisations, including development organisations, private enterprises and research organisations, and advisory and other support services from the public and private sector can lead such projects. Leadership depends on the theme being addressed. Projects usually involve a coalition of different types of organisations working together.

¹⁰ This research-extension model is globally known as the linear model or transfer-of-technology model.

- Such projects usually address issues at multiple levels. They may involve technological change but usually also involve addressing issues in institutional arrangements (how things are done, incentives etc.) as well as in the policy domain that frames activities and innovation.
- Different projects will, however, impact at different scales. Some will impact on individual communities or enterprises, some will impact on value chains, while others will impact at regional and national scales.
- Innovation projects are inherently process-driven – promoting innovation in different and dynamic contexts always needs to be learnt and improved through trial and error. This means that learning-oriented mentoring is a key management tool in these projects.
- Innovation projects have an explicit or implicit capacity-development agenda. Capacity development is an important driver of change in this case, because organisations have different institutional histories, organisation cultures and capacities to innovate. Hence, there is a need to provide space for organisations to work in new ways and with different partners. Such projects anticipate that institutional lessons (how to work differently for impact) are an important outcome.
- In this type of project, scaling out is not concerned with replication but with linking similar initiatives to promote lesson sharing and wider innovation. Scaling up is not concerned with formulation of recommendations for policy but with linking experiences and lesson learning to debates that shape wider policy and institutional frameworks and the nature and direction of development pathways.

Innovation projects should therefore strive to integrate technological, institutional and policy innovations to ensure sustainable social and economic benefits to the target groups. Importantly therefore, innovation grant schemes should broker related projects to ensure synergy from the three innovation pillars.

Entry points for innovation projects

The following are examples of innovation projects from the AIGS in Papua New Guinea:

- *Technology adaptation and troubleshooting.* Adapting technologies to different contexts of application and conducting research to resolve “second-generation” technical constraints encountered during application.
- *Strengthening technology delivery systems.* Creating viable demand-responsive delivery systems for new technologies, such as improved crop varieties, but also providing training in new production and marketing techniques and regulatory compliance. This may be done through the market or through public or civil society organisations providing advisory services.
- *Strengthening value chains.* Creating viable and equitable value chains that link smallholders to local, national and international markets. This might be in response to a new market opportunity. It may also be driven by new technological opportunities, such as new types of storage or value addition through agroprocessing.
- *Strengthening social organisations.* Creating farmer or commodity groups and enterprises as a way of improving production, process and marketing. This may also be used as a way of better accessing inputs, such as seeds or credit, and as a way of collectively articulating demand for research services and advisory support.
- *Strengthening innovation brokering.* Supporting service organisations to use facilitation, intermediation and communication to help build coalitions of partners around emerging opportunities. This might involve undertaking research and/or setting up innovation platforms to identify new opportunities and bringing partners together to exploit these.
- *Enterprise incubation.* This often involves providing start-up capital and technical assistance to enterprises involved in commercialising new technologies or services to

smallholders. It may also include mixed-revenue business models, where products and services are paid partly by the market and partly from public or private subsidy.

- *Policy and institutional change.* This involves generating, synthesising and communicating information to policymakers to change the framework conditions for a particular innovation pathway. It may involve support to specific interest-group agencies, e.g. an organic produce organisation. Alternatively, it might mean supporting policy thinktanks to link development practice experiences with the policy process.

Obviously, these are only entry points for projects. The AIGS in Papua New Guinea affirmed international experience that innovation projects work best when the different types of entry points are clustered together to address the different types of bottlenecks encountered in innovation processes (Hall 2011, Ton *et al* 2013, World Bank 2010).

Example of innovation grant scheme

Project title: Positive Sustainable Development of Smallholder Farming Communities through Value Addition and Market Improvement of Coconuts in Gazelle District.

Lead and other partners: Pacific Spices Ltd.

Duration: Initially one year, but extended by one more year due to implementation problems.

Budget: Kina 250,000 (approximately USD 120,751) approved and fully utilised.

Rationale: This project focuses on value addition through agroprocessing and marketing and involves a partnership between a private company and community groups. In the Gazelle District, the coconut industry had been relatively unsuccessful over the previous 20 years due to the inconsistency of prices of copra, increasing costs of fuel and lack of all-weather roads. This led to a decline in production of coconuts and copra at farmer level. Partly in response to this, Pacific Spices Ltd, a private company, started processing and adding value to selected cash crops to encourage farmers to produce these crops. This, in turn, helped Pacific Spices Ltd ensure consistency of supply. One of the initiatives involved the Sinivit community in Pomio District.

Main activities: Pacific Spices worked with community members to process coconut into virgin coconut oil and to market this in PNG and overseas. This helped households maintain regular cash income from coconut production. Besides providing technical know-how on producing organic products for the world market, the company also helped increase shipping freight services to the district, ensuring that the produce reached intended markets at least cost. The partnership was extended to include the East New Britain Provincial Government and the Catholic Mission.

The project funded the following activities:

- Renovation and upgrading of an existing building to a value added processing facility providing an efficient product flow - that not only reduced handling, but also maximised production capacity.
- Procured and established a coconut processing equipment, resulting in production of quality virgin coconut oil and other coconut byproducts.
- Provided hands-on staff training regarding product quality and hygiene issues associated with high-value/perishable food products, coupled with the consistent production of coconut oil.
- Storage facility for a crystal clear virgin coconut oil that allowed for packaging of 350 kgs of organic virgin coconut oil for export to Japan.
- Logistic arrangements for a copra buying point at Induna Plantation to provide an on-site market for farmers.
- Data collection from farmers in three outreach communities – Merai, Lat and Gar – including crop and production history.

- Organic certification for grower group and processing facility gained to the international organic standard (International Federation of Organic Agricultural Movements – IFOAM). Coconut, Nutmeg, Patchouli and Cocoa listed as organic.
- Five-day visit to Rabaul by a buyer from Australia looking for consistent supply of coconut oil. Sales agreement discussed and agreed for the supply of coconut oil and other coconut products on a monthly basis.

Roles of different partners

Pacific Spices and the Catholic Mission worked in partnership on the Induna Plantation, which is owned and managed by the Catholic Mission. Farmers in the vicinity of the plantation sold their produce to the processing firm. In addition, Pacific Spices provided the certification process for organic coconut oil production and linked farmers with the Sea Transport and Marketing Service, leading to better prices for their produce. This partnership clearly demonstrated the role of an integrated approach to rural development, whereby the development of transport routes to and from the market paved the way for additional economic and social benefits to the smallholder producers in the area.

Outcomes

- Linked the local coconut market with international markets in Canada, Japan, Europe and America, through value adding and organic certification of their products
- Market opportunities encouraged farmers to invest their time and other resources to improve profitability levels
- Created network of local communities, using family ties and village leadership to promote production and productivity of coconut, especially organic production methods
- Farmers using increased incomes to give their families better healthcare and education
- The initiative that began in one ward eventually expanded to three wards.

Challenges of innovation projects

A lack of a common understanding among key stakeholders on the concept of innovation and how innovation systems operate was the biggest challenge in implementing the AIGS. Among some key stakeholders, the scheme was perceived as a mechanism to transfer technologies from research to farmers. This reflected a legacy of previous capacity-development approaches, which focused on funding research for technology development and supporting extension systems for disseminating technologies. Most of the AIGS leadership was initially heavily influenced by this perspective. Consequently, it took about a year and a half to broaden their perspectives to embrace innovation systems thinking.

Lesson and recommendations

New projects will usually build on existing clusters of innovation activity – technological development, enterprise or developmental activity and market changes that provide opportunities for innovation of economic and social significance. Grant schemes, therefore, need to have scoping mechanisms to identify promising nodes of innovation (for details, see Mbabu & Hall 2012).

AIGS holds many operational and policy lessons for those designing competitive funding mechanisms to support innovation as part of the AR4D approach. These include:

- The importance of creating operational space to experiment with and incubate a novel form of innovation grant scheme; this helps develop workable institutional arrangements that are fit-for-purpose and provide proof of concept that can be leveraged in wider policy debates.

- The importance of ensuring that all key stakeholders fully understand the idea of innovation and the wider paradigm of AR4D and the implications this has for the design and operation of an innovation grant scheme.
- The importance of conceiving and operating the scheme as a way of stimulating agricultural production, processing and marketing innovations, as well as innovations in service delivery; this means supporting new ways of working by sector stakeholders.
- The importance of tailoring funding calls to themes that will allow a scheme to demonstrate its wider utility beyond the agricultural sector as a policy instrument that can contribute to national development plans and goals.
- The importance of an iterative approach to funding, learning from the experience of earlier calls and adjusting future calls accordingly.
- The importance of staffing grant schemes with people who have the right skill mix to support an AR4D orientation. It might also be necessary to provide staff space to “learn by doing” as no manual is available for many of the tasks they are likely to encounter.
- The importance of focusing calls on identifying innovation opportunities and then structuring support and partnerships around these opportunities. As some partners will be new to the world of proposal development (particularly non-traditional partners), considerable technical support needs to be provided in proposal development.
- The importance of robust result frameworks and monitoring and evaluation arrangements to ensure that innovation grant schemes continue to focus on higher-order development objectives that have been set for them.

There are also pitfalls that are best avoided:

- Inheriting institutional arrangements from technology-transfer grant schemes places an extra burden on the institutional development of innovation grant schemes. Personnel with experience in technology grant schemes are probably best avoided, although this can sometimes be difficult.
- Avoid the temptation to issue calls before at least basic institutional arrangements have been put in place. Donors should note that the imperative to spend money quickly may undermine the ability of the grant schemes they are supporting to achieve their purpose.

Conclusions

Agricultural innovation grants need to be conceived and practised as an opportunity to translate ideas and research results into concrete social and economic benefits through facilitation of *learning by doing* and providing complementary inputs through grants in cash or in kind or a combination of the two. The overall idea is to link research with development in a manner that contributes to improved livelihoods, especially of the resource-poor smallholder producers, by involving various stakeholders in the innovation processes.

References

- Hall A. 2011. Putting agricultural research into use: lessons from contested visions of innovation. UNU-MERIT Working Paper Series #2011-076. Maastricht: UNU-MERIT.
- Mbabu AN & Hall A. 2012. Capacity building for agricultural research for development: lessons from practice in Papua New Guinea. Maastricht: UNU-MERIT.
- Ton G, Grip K de, Klerkx L, Rau ML, Douma M, Friis-Hansen E, Triomphe B, Waters-Bayer A & Wongtschowski M. 2013. *Effectiveness of innovation grants to smallholder agricultural producers: an explorative systematic review*. London: EPPI-Centre, Social Science Research Unit, Institute of Education, University of London.
- World Bank. 2010. Designing and implementing agricultural innovation funds: lessons from competitive research and matching grant projects. Report No. 5457-GLB. Washington DC: World Bank Agriculture and Rural Development Department.

Reflection on innovation processes in a smallholder goat development project in Mozambique

Birgit K. Boogaard^{1*}, Kees Swaans¹, S.C.J. Hendrickx¹ and M.Cosijn²

¹ *International Livestock Research Institute (ILRI), Maputo, Mozambique, and Addis Ababa, Ethiopia*

² *Cooperative for Assistance and Relief Everywhere (CARE), Maputo, Mozambique*

* Corresponding author. Email: birgit.boogaard@wur.nl

Abstract

There is an increasing interest among researchers, practitioners and donors in using agricultural innovation systems approaches to reach development outcomes. Limited practical experiences have been shared on the dynamics of these innovation processes and how project partners have dealt with that. The objective of this paper is therefore to share experiences from a smallholder livestock development project – the imGoats project in Mozambique – by reflecting on the dynamics of innovation processes in the project.

The paper focuses on three intervention domains of the imGoats project: improving access to animal health services, improving market access and developing communal grazing areas. For each area, the innovation process was analysed by looking at the following elements: local context, innovation type, actors involved, people taking the initiative, changing context, flexibility of project partners, pace of the process and results. The findings show that the innovation processes of the three intervention domains varied considerably in terms of participation of actors, predictability of the process, expected and unexpected results, and degree of experimentation. Different innovation processes coexisted in the same project context, but were closely interrelated. Each addressed a particular constraint, which together contributed to the overall development objective of the project, though each innovation process was different. These findings and challenges have implications for research, practice and policy. For example, the dynamics of innovation processes may vary and depend on the intervention domain; this asks for a critical reflection on the role of research, facilitation and brokering in each of these cases. Innovation processes require flexible management and should allow for joint experimentation and learning among project partners, stakeholders and decision-makers. Flexibility in project design and donor funding is needed so that not only “obvious” interventions but also unforeseen developments are catered for.

Keywords: *goats, markets, smallholders, innovation process, diversity*

Introduction

There is an increasing interest among researchers, practitioners and donors in using agricultural innovation systems approaches to achieve development outcomes like increased incomes and food security (e.g. Knickel *et al* 2009, Tenywa *et al* 2011). Underlying theories are currently crystallising and give valuable new insights into the processes of innovation. Innovation processes are often highly context-specific and the outcomes are difficult to predict (e.g. Hall 2007, Klerkx *et al* 2012). Hence, there is no blueprint to enhance innovation; instead, there is a need for recognition of diversity of innovations that are adapted to local conditions, i.e. “letting a thousand flowers bloom” (Hall 2007). Such approaches require a high degree of flexibility of project partners, such as farmers, NGOs, national and international agricultural research institutes, and donors to adapt to local and changing situations (e.g. Hall 2007, Klerkx *et al* 2012).

The underlying theory is rather clear, but relatively limited practical experiences have been shared on the dynamics of these innovation processes and how project partners have dealt

with the dynamics within an existing project design. The objective of this paper is to share experiences from a smallholder livestock development project – the imGoats project in Mozambique – by reflecting on the dynamics of innovation processes in the project.

Materials and methods

The imGoats project aimed to increase income and food security in a sustainable manner by enhancing goat value chains. CARE Mozambique and the International Livestock Research Institute (ILRI) implemented the project in Inhassoro District, Mozambique, from February 2011 to June 2013. The project worked with about 500 goat producers in 19 communities in Inhassoro District (Inhambane Province). The project rationale was that market opportunities for goat smallholders could be increased by improving communication and coordination between value-chain actors through an innovation platform (IP). This paper describes the process of innovation rather than the multistakeholder processes. It is however recognised that the two concepts are clearly interlinked and that multistakeholder processes are important to enhance innovation (e.g. Nederlof & Pyburn 2012). Over a two-year period, nine IP meetings took place. Monitoring was done using Outcome Mapping, while detailed reports were made of each IP meeting.

The paper focuses on three intervention domains: improving access to animal health services, improving market access and developing communal grazing areas. For each area, the innovation process was analysed qualitatively by looking at the following elements (adapted from Triomphe *et al* 2012): the local context, innovation type, actors involved, people taking the initiative, changing context, flexibility of project partners, pace of the process, and results.

Findings

Improving access to animal health services

In Mozambique, there are no animal health services for goats although disease occurrence is one of the main production constraints. CARE had experience with training paravets¹¹ (community animal health worker, Figure 1) to treat cattle in the local context. Building on this experience, 16 paravets were trained to treat goats. Based on this proven model, CARE and ILRI took the initiative at the project start. The innovation contained a technological component – e.g. treatment against ticks – as well an organisational component, e.g. paravets started working together with producers, community leaders and local government staff. Existing extension and training models were refined, but otherwise limited changes were required. As such, also limited flexibility was asked from the project partners. Due to CARE's experience and the biweekly meetings of CARE extension officers with each paravet, the pace of the process was rather quick: within two years, 16 paravets had been trained and smallholders were using and paying for paravets' services, thus contributing to the intervention's sustainability.



Figure 1: Community animal health worker treats goats against ticks

¹¹ Paravets were trained as a part of a 7-year project called Sustainable Effective Economic Development (SEED) funded by CIDA (Canadian International Development Agency).

Summarising, the innovation process can be described as a rather predictable process, as it was planned and led by CARE/ILRI and included familiar stakeholders and relatively straightforward activities.

Improving market access

Goat keepers in Inhassoro District usually sell their goats irregularly when there is a household need (Boogaard *et al* 2012). There are no goat markets in the district, but CARE had experience with setting up cattle fairs in neighbouring districts. The initiative was taken by the IP members and CARE/ILRI during an IP meeting. The innovation consisted of an organisational component – increased coordination between value-chain actors – and an institutional component – the introduction of weighing scales by CARE and a pre-established liveweight price to guarantee a fair price (Figure 2). Over time, the situation changed considerably as demand for goats was lower than anticipated and traders were reluctant to use the scale. Subsequently, CARE and ILRI experimented with different market models, e.g.



Figure 2: Goat fair: goat weighing (left) and female goat keeper counting money after sale (right).

exploring the local market, involving the private sector and commercial investors, and exploring markets at longer distances (e.g. Maxixe market at 250 km and Maputo market at 800 km). These changing market conditions required high flexibility of the project partners, and the pace of the process was rather slow. Moreover, the project partners had less experience with this innovation domain compared to animal health. In the two years of the project, six goat fairs were organised, with varying degrees of success in terms of sales numbers (ranging from 0 to 77 goats sold per fair).

The innovation process can be summarised as being partially planned, led by CARE/ILRI together with IP members, and including familiar and new stakeholders and activities. Overall, the process was rather unpredictable.

Developing communal grazing areas

Most goats in Inhassoro District are tethered (Boogaard *et al* 2012) even though grazing areas are present in the district (Figure 3). Moreover, there are limited documented experiences with communal grazing areas in Mozambique. The IP members identified the need for communal grazing areas in an IP meeting. The innovation consisted of an organisational component – collective action between smallholders, community leaders, paravets and local government – as well as an



Figure 3: Communal pasture area

institutional component (legalisation of the areas by the district government, including demarcation of the area, and the establishment of an association in three communities which was legally responsible for the area). These activities were unexpected and unplanned by CARE and ILRI. As such, it required high flexibility, which included joint experimentation and learning, involving an additional study on carrying capacity of grazing areas (Marblé 2012) and the development of training modules for CARE staff and goat keepers. CARE also supported local government to act on existing land-use strategies. The pace of the process

was intermediate: it took time for the project partners to learn about this new domain, but legalisation went relatively smoothly because it connected to existing land-use strategies of the Mozambican Government. At the end of the project, communal grazing areas have been identified in 12 communities. However, challenges remain such as collective management, theft, lack of herders and uncontrolled fires.

The innovation process can be summarised as unplanned, led by IP members and other actors with strong input from CARE and ILRI, involving new stakeholders and activities, i.e. an unexpected and unpredictable process.

Challenges and implications

A major challenge for the imGoats project was the tension between the project objective to contribute to development outcomes in a relatively short project period (30 months) and the different paces of the unfolding innovation processes. For example, the development of market models took more time than anticipated and it was difficult to keep traders engaged throughout the project. Moreover, the support of unplanned ideas, e.g. communal grazing areas, required significant resources from CARE and ILRI.

These findings and challenges have implications for research, practice and policy. The following recommendations can be made:

- Innovation processes ask for flexibility, joint experimentation and learning among project partners.
- The high diversity of innovation processes requires flexibility in and reflection on the roles of research in Research for Development (R4D), e.g. in terms of facilitation and brokering. The latter can be described as a “third-party position, purposefully catalyse innovation through bringing together actors and facilitating their interaction” (Klerkx & Gildemacher 2012: 221).
- Participatory monitoring and evaluation is needed to capture the dynamics of innovation processes and learning.
- Decision-makers need to be engaged in the process to ensure that innovations are embedded in government strategies and policies.
- Project design and donor funding should allow for a certain degree of flexibility, e.g. by agreeing during the project design phase that the final decision on the project interventions will be taken after one or two years of project implementation.

Conclusions

Based on these findings, the following conclusions on innovation processes can be drawn:

- The three innovation processes varied considerably in terms of the participation of actors, predictability of the process, expected and unexpected results and degree of experimentation.
- Each innovation process addressed a particular constraint, but the different constraints were closely interrelated; together they contributed to the overall development objective of the project.
- The co-existence of different innovation processes in the same project context required substantial flexibility from project partners in terms of managing these processes.

In addition to the conclusions mentioned here, it is likely that the different innovation processes positively influence each other. For example, quick gains through planned interventions may build the necessary trust between farmers and other stakeholders to address more persistent and unforeseen problems. However, as this was not the focus of our study, we cannot make strong conclusions in this regard.

References

- Boogaard BK, Hendrickx SCJ & Swaans K. 2012. Characterization of smallholder goat production and marketing systems in Inhassoro District, Mozambique: results of a baseline study. ILRI Research Brief. Maputo: International Livestock Research Institute.
- Hall A. 2007. Challenges to strengthening agricultural innovation systems: where do we go from here? UNU-MERIT Working Paper Series #2007-038. Maastricht: UNU-MERIT.
- Klerkx L & Gildemacher P. 2012. The role of innovation brokers in agricultural innovation systems. Thematic note 4. In: *Agricultural innovation systems: an investment sourcebook* (Washington DC: World Bank), pp221–230.
- Klerkx L, Mierlo B van & Leeuwis C. 2012. Evolution of systems approaches to agricultural innovation: concepts, analysis and interventions. In: Darnhofer I, Gibbon D & Dedieu B (eds), *Farming Systems Research into the 21st century: the new dynamic* (Dordrecht: Springer), pp457–483.
- Knickel K, Brunori G, Rand S & Proost J. 2009. Towards a better conceptual framework for innovation processes in agricultural and rural development: from linear models to systemic approaches. *Journal of Agricultural Education and Extension* 15 (2): 131–146.
- Marblé Y. 2012. Creation of communal grazing areas for goats in southern Mozambique: future perspectives. MSc thesis in Animal Science, Wageningen University.
- Nederlof ES & Pyburn R (eds). 2012. *One finger cannot lift a rock: facilitating innovation platforms to trigger institutional change in West Africa*. Amsterdam: KIT Publishers.
- Tenywa MM, Rao K, Tukahirwa JB, Buruchara R, Adekunle AA, Mugabe J & Wanjiku C. 2011. Agricultural innovation platform as a tool for development oriented research: lessons and challenges in the formation and operationalization. *Learning Publics Journal of Agriculture and Environmental Studies* 2 (1): 118–146.
- Triomphe B, Floquet A, Kamau G, Letty B, Vodouhê SD, Ng'ang'a T, Stevens JB, Berg J van den, Sellamna N, Bridier B, Crane T, Almekinders C, Waters-Bayer A & Hocdé H. 2013. What does an inventory of recent innovation experiences tell us about agricultural innovation in Africa? *Journal of Agricultural Education and Extension* 19 (3): 311–324.

Experiences with aloe domestication and exploitation, Baringo County, Kenya

Josephat Mulindo Chengole^{1*}, Martin Welimo², Raphael Belmin³, Geoffrey Kamau⁴, Teresiah Ng'ang'a⁵ and Bernard Triomphe⁶

¹ Kenya Agricultural Research Institute, Perkerra, Kenya

² Kenya Forestry Research Institute, Baringo, Kenya

³ INRA Laboratoire de Recherches sur le Développement de l'Élevage, Corte, France

⁴ Kenya Agricultural Research Institute Headquarters, Nairobi, Kenya

⁵ PROLINNOVA–Kenya, Nairobi, Kenya

⁶ CIRAD UMR Innovation, Montpellier, France

* Corresponding author. Email: cjmulindo@gmail.com

Abstract

This paper relates the findings of a participatory assessment of innovation processes surrounding the domestication and exploitation of *Aloe* genus in semi-arid Kenya. The research was conducted under the EU-funded JOint Learning in Innovation Systems in African Agriculture (JOLISSA) project. The assessment approach consisted mostly of conducting individual or group semistructured interviews with key stakeholders related to aloe. The objective was to understand the dynamics of aloe domestication and exploitation and the interactions between the stakeholders involved.

Stakeholders included the Kenya Forestry Research Institute (KEFRI), Kenya Wildlife Service (KWS), Office of the President, Koriema-Kimalel-Sabor (KOKISA) communities, an community-owned Aloe processing unit, Aloe management community groups, a private sector aloe trader and exporter, independent aloe sap growers, processors and traders. The innovation process developed in two parallel threads, with little interaction among them. On one hand, an informal thread developed which was headed by Aloe sap traders who induced and developed a non-official supply chain to collect and process sap harvested from wild aloe for a mostly non-regulated export market. In so doing, they developed a number of innovations (such as sap purity tests) and also trained farmers on different aspects of harvesting and processing aloe sap. They also came up with barter schemes to resolve the problem of low capital available to buy sap. This informal value chain was however deemed illegal, shunned by public institutions. On the other hand, an initial presidential ban on wild aloe harvesting triggered the interest of the scientific community. Aloe domestication and exploitation received donor support with the intention to develop the various components of a certified sustainable harvesting and marketing aloe value chain. This included establishing a public-private partnership (PPP) to build and operate a factory for processing aloe sap and the establishment of Aloe Management Units (AMUs) in different communities to supply aloe sap to the factory from established aloe plantations rather than from the wild. Difficulties with access to the export market and pricing resulted in the near-collapse of the certified value chain, as the community members drifted towards the informal value chain and a search for alternative outlets in the form of aloe-based cosmetics such as soap, lotions and other herbal preparations.

Several lessons and recommendations were learnt from this assessment including the need to build on pre-existing innovation dynamics (such as the non-official aloe supply chain) rather than trying to replace or ignore them. This case also illustrates the need to build the capacities necessary for effective management of a PPP and access to complex export markets. It furthermore shows that, even if a public policy, such as the presidential ban on Aloe, is flawed or incomplete, it can still trigger valuable innovation.

Keywords: aloe, Kenya, joint learning, innovation processes

Introduction

Aloe spp have been used for food and medicine in Kenya for many years. Over time, the dynamics of aloe use shifted from sustainable local use to overexploitation because of export demands (Mukonyi *et al* 2001). This led to a Presidential Decree in 1986 declaring the plant endangered; as a result, aloe was placed on a protected list of endangered plant species in Kenya. However, on account of i) the failure of other countries to restrict exploitation of the plant and ii) the growing demand for aloe products, illegal harvesting of the plant persisted further and threatened the species (Wabuye & Kyalo 2008). In an effort to stem uncontrolled exploitation, a programme to domesticate the plant for sustainable utilisation started in Baringo County in 2004. The programme, with funding from the European Union (EU), was initiated in the communities living around Koriema, Kimalel and Sabor and coordinated by KEFRI after recommendations of the research work triggered by the Presidential Decree that banned wild harvesting of aloe. It involved the establishment of a factory for processing aloe into exportable products. An elaborate arrangement involving a myriad of stakeholders was set up to achieve this. The aim was to divert community attention from wild to domesticated aloe to generate income.

After over six years of aloe domestication and exploitation, a participatory assessment was made within the framework of the EU-funded FP7 project JOint Learning in Innovation Systems in African Agriculture (JOLISAA). The aim of the assessment was to understand the dynamics of aloe domestication and exploitation and the interactions among stakeholders.

Materials and methods

Study area

This study was conducted in Baringo County, which is divided into the south, central and northern parts. The south and central areas are occupied by the Tugen people (the Lembus Tugen in the south and the Samor Tugen in the central area) while the north is dominated by the Pokot. While the Tugen are agropastoral, the Pokot are pure pastoralists. The population density is unequally spread from 29 persons per km² in the north to 72 persons per km² in the south. The north is mainly dry, whereas the south receives some rainfall that allows marginal crop production. The area experiences one rainy season from April to August and a long dry season, with temperatures ranging between 16 and 30°C. A south-north escarpment called the Tugen Hills divides the county into two parts, with the Njemps Flats in the east and the Kerio Valley in the west. The long-term average annual rainfall ranges from 600 mm in the lowlands (Njemps Flats and East Pokot) to 1000–1500 mm in the highlands (Tugen Hills). Thus, with the exception of the Tugen Hills, Baringo County is largely an arid and semi-arid land. *Aloe* spp grows widely throughout the region. The communities have been utilising this and other natural plant resources for food, medicine and cosmetics for years. Compared to the north, the south and central areas have a more developed infrastructure in terms of access roads, developed markets and availability of livelihood options. The factory for aloe processing is located in the central area.

Data and information collection

Data were collected by means of a desk study, semistructured interviews, general group discussions and one feedback workshop. Much of the data collected was qualitative, and simple statistical procedures were used in the data analysis.

Project assessment reports, workshop presentations and correspondence were reviewed during the desk study. These were mainly sourced from the Internet, libraries and direct communication from key persons with in-depth knowledge of aloe. Resource persons were selected from the Aloe Management Units, the Kenya Forestry Service and the Ministry of Agriculture. They were interviewed according to a question guideline comprising various topics, around which specific questions had been formulated. Three general group

discussions were held: in Radat in the south, in Koriema in the central area and in Kolowa in the north. At each site, 30 participants were invited to the meeting and a checklist of 12 guideline questions was used to elicit information from them. A stakeholder workshop was organised at the end of the study to validate results and fill in any gaps. Many of the results presented here were obtained during the fieldwork conducted over the period May–November 2012 for an MSc thesis (Belmin 2013).

Results and discussion

Overall, the aloe domestication and exploitation process as envisaged originally at the start of 2004 was a failure, based on this assessment. The aloe nurseries collapsed, little was achieved in setting up aloe plantations and the factory became an idle monument to the failed process.

Stakeholders

Eight major stakeholders in aloe domestication and exploitation process were identified. Of these, three were public entities (Kenya Forestry Research Institute, Kenya Wildlife Services and the Provincial Administration), three were private business entities (Land Mawe Company, aloe sap traders and aloe boilers) and two were community-based outfits (AMUs and Self-Help Groups). Information in the marketing of aloe sap and other aloe-based products was skewed in favour of the private business entities. However, this segment – particularly aloe boilers and aloe sap traders – were sidelined in the formal arrangement recognised by the government in the process of aloe domestication and exploitation. This contributed greatly to the failure of the aloe domestication and exploitation effort. The private entities, commonly called the informal value-chain actors for aloe, responded appropriately to the demands of the aloe sap collectors since they paid for the sap on delivery and even entered a barter trade arrangement with the sap suppliers for provision of foodstuffs in the event of liquidity problems. They concentrated their activities in the northern side of the county, where dependency on aloe was high and the distance to the factory was far. They easily offered a better alternative to the formal value chain for aloe.

Innovations

The research identified a range of technical and organisational innovations. The technical innovations revolved around the domestication procedure of aloe and the production of aloe sap. Each innovation was triggered by a problem that needed to be solved. Instead of planting and raising aloe plantations as it had been planned originally, many farmers hived and fenced off aloe-infested farms and made them “private plantations”. This was in an effort to circumvent the high costs involved in establishing aloe plantations.

To prevent adulteration of aloe sap, aloe sap traders and aloe sap boilers tested its purity by pouring a little quantity on the ground. Adulterated material spread liberally while pure sap held together. This innovative way of testing the purity of aloe sap originated with the boilers after a long time of being shortchanged by the sap collectors. To prevent wastage in transit, many boilers processed the aloe sap into gum at the point of origin and then transported the solid gum to the assembly point in Marigat town.

The Aloe Management Units (AMUs) and the Baringo Aloe Bio-Enterprise (BABE) were organisational innovations. The AMUs were established as part of the organisational structure of the aloe domestication and exploitation project and were the link between the factory and the aloe farmer. The AMUs bulked aloe sap from the collectors and delivered it to the factory on behalf of the members. This reduced the transportation costs through economies of scale. However, the AMUs lacked the capacity to handle their responsibilities since they were not adequately trained. They disintegrated and members resorted to harvesting aloe sap from the wild and delivering to the informal traders and boilers as individuals. BABE was set up to run the affairs of the aloe factory on behalf of the

community. Membership was made up of stakeholder representatives, making it apparently possible for every member of the community to have a say in the affairs of running the factory. BABE failed in its responsibilities because of internal wrangles among the community representatives and between the community members and the private investor (Land Mawe Company). The wrangles led to the pullout of Land Mawe Company, leaving BABE with no capacity to market aloe products. In the meantime, the informal value-chain actors, who had the capacity to link to the global markets, continued to thrive. These were to be found stationed in the north where, for alternative sources of livelihood, the Pokot community continued to harvest wild aloe for sap. The factory in the central area failed, as the local Tugen community turned to other viable sources of livelihood such as crop production, honey marketing and formal employment in the nearby urban centres.

Lessons learnt

Several lessons were learnt from this research. Key was that it would be better to take stock of existing initiatives at a site and build on them when introducing a project instead of neglecting them. For instance, the aloe domestication and exploitation project would have had a higher success probability if it integrated the informal aloe value-chain actors instead of making them illegal and sidelining them. The aloe CCA case also illustrates the need to build the capacities needed for effective management of a PPP and access to complex export markets. The formation and capacity building of the AMUs and BABE members were not done effectively. KEFRI took on the task but lacked the strategic capacity to train the AMUs and BABE on group dynamics and to create a link between AMUs, KOKISA and BABE. In the face of simple misunderstanding, the groups simply disintegrated. Finally, the study showed that, even if a policy is flawed or incomplete, it can trigger valuable innovation, as occurred with the presidential ban on wild aloe harvesting.

Key challenges

During the aloe assessment, a number of challenges were recognised. For one, it was difficult to manage the expectations of the community members. When the assessment team started its activities, the community initially thought it was another initiative to try and revive the failed aloe domestication and exploitation project. The other challenge was holding the assessment team together during the whole exercise. The activity was time-consuming and, because it stretched over several months, some team members — especially from the community — lost commitment to the activity because of other pressing issues.

Conclusion

A revisit of the implementation of the aloe domestication and exploitation process should be made and must be all-inclusive, recognising the role of the informal players. Despite their wealth of information about aloe processing and marketing, they were sidelined legally, causing the project to fail.

References

- Belmin R. 2013. Analysis of the innovation process linked with the activation of a natural resource in Baringo, Kenya. MSc thesis, Montpellier Supagro, France.
- Mukonyi KW, Owuor B, Chikamai BN & Wabuye E. 2001. A review and appraisal of the aloe resources in Kenya; utilization and development status. Unpublished KEFRI Report, July 2001.
- Wabuye E & Kyalo S. 2008. Sustainable use of East African aloes: the case of commercial aloes in Kenya. Published online at www.conabio.gob.mx

The JOLISAA project was funded under European Commission FP7 Grant Agreement 245319. The opinions expressed herein are the sole responsibility of JOLISAA. More information on JOLISAA can be found at www.jolisaa.net

From a desired to a despised and later desired tree: the case of prosopis introduction and management in Marigat, Baringo County, Kenya

Josephat Mulindo Chengole^{1*}, Martin Welimo², Raphael Belmin³, Teresiah Ng'ang'a⁵ and Geoffrey Kamau⁴

¹ Kenya Agricultural Research Institute, Perkerra, Kenya

² Kenya Forestry Research Institute, Baringo, Kenya

³ INRA Laboratoire de Recherches sur le Développement de l'Élevage, Corte, France

⁴ Kenya Agricultural Research Institute Headquarters, Nairobi, Kenya

⁵ PROLINNOVA–Kenya, Nairobi, Kenya

* Corresponding author. Email: cjmulindo@gmail.com

Abstract

This paper describes the innovation process surrounding the development of strategies for sustainable management of *Prosopis* spp in Baringo County of Kenya over a 10-year period. The findings are from an assessment made under the JOint Learning in Innovation Systems in African Agriculture (JOLISAA) project, in which key stakeholders involved in the utilisation and management of prosopis were interviewed. The objective was to understand the dynamics of prosopis management in Baringo County and interactions between stakeholders.

Following serious drought in the 1970s, Baringo and other arid and semi-arid lands in Kenya were depleted of grasses and other vegetation. The Food and Agricultural Organization (FAO) and the Kenya Forestry Research Institute embarked on an effort to test a diversity of tree species that would perform well and the exotic *Prosopis juliflora* species, commonly called prosopis, outperformed all. This tree was promoted and revegetation was successfully accomplished. Everybody loved the plant, for it was a source of shade, soil cover, firewood and livestock feed. However, late in the 1990s and early 2000s, its invasive nature soon proved to be a challenge. The plant invaded grazing lands, choked waterways, blocked paths and even caused the relocation of a shopping centre. Not much had been known about the plant behaviour before its introduction and no environmental impact assessment had been done to determine beforehand its probable effects on the environment. Efforts to address these challenges were initiated in 2004 and, close to a decade later, the JOLISAA study tried to understand how the whole process had unfolded.

The community and other stakeholders developed various technical and socio-organisational innovations. A key policy innovation was revision of the charcoal-burning act by the Kenya Forestry Service to legalise the burning and sale of prosopis charcoal to generate income. The community, which culturally abhorred charcoal burning, turned to the activity when they saw it was lucrative. An integrated approach to managing prosopis led to changes in the socio-economic situation, thus changing the attitude of local people to regarding prosopis as a desired rather than a despised tree.

Lessons learnt were that a negative perception of an introduced intervention may derail its positive long-term impacts, adjusting a policy environment can support innovation and private-sector participation can ensure that an innovation is linked to the market, which is important for its relevance and acceptance. It was also apparent that socio-economic gains can override cultural perceptions. From this case, it was concluded that a legal framework should be put in place to regulate the charcoal industry, including setting and enforcing standards.

Keywords: *prosopis, invasive weed, market, charcoal, policy*

Introduction

Arid and semi-arid areas of Kenya are characterised by dry spells that can stretch for long periods, posing a challenge because of depletion of vegetation and other feed resources. Such a spell occurred in Baringo County in the 1970s, during which grasses and other vegetation and feed resources disappeared. The FAO and the Kenya Forestry Research Institute (then Forestry Research Department) embarked on an effort to test diverse tree species for their use in revegetating the area. *Prosopis juliflora* from South America outperformed the other species. Various agencies then promoted it for use in revegetation. Not much was understood about the inherent behaviour of prosopis. The plant seemed to provide much-needed reprieve for the communities in Baringo by: providing good land cover and shade, reducing dust storms, providing firewood and fencing/building material, and providing much-needed livestock feed. In the late 1990s and early 2000s, the real behaviour of the plant became manifest. The invasive nature of *Prosopis juliflora* soon proved to be a challenge to grazing lands, waterways, walking paths and – in an extreme case – it caused the relocation of a shopping centre. The thorns from the plant were alleged to be poisonous, resulting in amputation of limbs of those affected. A legal suit was filed in the high court by community members who sought compensation for the distress that the tree caused (Kenya Law Reports 2002). A project was then initiated to seek management options, which led to emergence of various technical, social and organisational innovations (Chengole *et al* 2006). The JOint Learning in Innovation Systems in African Agriculture (JOLISAA) project conducted an assessment of the case to assess how the innovation process had unfolded. A synthesis of the findings led to some lessons and recommendations for research, policy and practice.

Methodology

The assessment of the prosopis case was made by researchers from the Kenya Forestry Research Institute (KEFRI), the Kenya Agricultural Research Institute (KARI), community members, a student and a research assistant. The study methods included a desk review, semistructured interviews, general group discussions, focus-group discussions and a feedback workshop, which allowed for reflection and validation of the data collected.

A review was made of information gained from project reports, workshop presentations and correspondence sourced mainly from the Internet and libraries and direct communication with key persons who had in-depth knowledge of prosopis. Resource persons were selected from the Kenya Forestry Service (KFS) and Ministry of Agriculture and interviewed, using a question guideline that covered various topics around which specific questions had been formulated. Two general group discussions were held: in Salabani and in Ng'ambo. At each site, 30 participants were invited to the meeting and a checklist of 12 guideline questions was used to elicit information from them. A stakeholder workshop to validate results and fill in gaps was held at the end of the study.

Results

The prosopis-invaded area in Marigat Division of Baringo County is predominantly arid to semi-arid, rocky and highly degraded. It has highly variable and unreliable rainfall of 700–900 mm and an average annual rainfall of 650 mm with weak bimodal peaks in March–May and June–August. Temperatures vary from 30°C to 35°C, and acacia woodland and shrub grassland are the main vegetation types (Wasonga 2009). The soils are shallow and mainly clay loams. The community living here are the Ilchamus or Njemps, who are predominantly agropastoralists, and overgrazing and cattle rustling are reported to be common (Choge *et al* 2002). Firewood is the principal fuel used locally. Until recently, the community regarded charcoal burning as an activity only for the poor and destitute. The introduction of *Prosopis juliflora* and its eventual management occurred broadly in five phases:

1. **Introduction of prosopis to Africa (1822–1930s):** Introduction of prosopis tree species into Africa from the Americas occurred through Senegal (1822), South Africa (1880), Egypt (1900) and Sudan (1917) and into Kenya in the 1930s. The tree was reportedly grown for fodder and shade and as an ornamental plant (Choge *et al* 2002).
2. **Formal introduction of prosopis in the country as a drought remedy (1973–late 1990s):** In 1973, the tree was among various provenances that were tried for rehabilitation of the Bamburi quarries near the coastal city of Mombasa (Johansson 1985 cited by Choge *et al* 2002). In 1982, the tree was introduced into Baringo County to revegetate denuded lands and provide livestock feed and wood for households through the Fuelwood/Afforestation Extension Project. This was a two-phase collaborative project between FAO, the Government of Kenya, the Department of Forestry, KEFRI and KARI. Land acquisition for tree planting was through negotiations between project staff and the pastoralist communities, who were initially apprehensive because they feared that the Forestry Department might one day gazette such land, rendering it inaccessible to the traditional owners (Kariuki 1993). The project established demonstration plantations, recruited pastoralists and agropastoralists to do individual tree planting, and trained them in this. A central seedling nursery was started together with 19 smaller nurseries, and seedlings were distributed to the pastoralists. Plots were established by local communities through food aid from the World Food Program, in which over 1000 local men and women were employed on a food-for-work basis. Among other tree species, the prosopis seedlings picked up well and started producing pods. These were eaten by animals but, after being passed out through dung, seedlings sprouted – thus marking the beginning of the invasive character of the species.
3. **Invasion, calls for eradication and court case (2000–06):** By 1997, the plant had invaded large areas of the region and, by 2000, it had spread along riverbanks leading to changes of river courses and even – in an extreme case – the Endao shopping centre in Marigat Sub-County had to be relocated because of the invasion of prosopis. The trees outcompeted grass and the livestock ate prosopis pods, the high sugar content of which was suspected to cause dental problems in goats. The prosopis thorns were also a health hazard by inflicting septic wounds. Prosopis plants were also reported to cause damage to house walls, and livestock were being entangled in the prosopis bushes (Michieka 2004). In 2000, the community sued the FAO and the government for the introduction of the plant, referred to as “*mathenge*” or the “devil’s weed”. A goat that was toothless allegedly because it had eaten prosopis pods was presented as an exhibit by nine members of Njemps community from Ngambo Location. The court ordered the government in collaboration with the community to check the spread of the plant through collaborative management (Kenya Law Reports 2006).
4. **Research, collaboration and innovations (2006–09):** FAO in collaboration with KEFRI, the Rehabilitation of Arid Environments (RAE) Trust, KARI, KFS and others spearheaded the prosopis management and control efforts. The local people were trained through participatory Farmer Field Schools (FFSs) in how to control the spread of prosopis through charcoal burning using efficient kilns, pruning the prosopis, splitting timber and making wooden tiles, wood carving, and grinding pods into feed. To encourage charcoal burning, the KFS introduced a license for prosopis charcoal burning. The International Livestock Research Institute (ILRI) organised a stakeholder workshop and introduced Sigma Feeds Ltd, which explored the use of prosopis pods in feed rations. ICRAF, KARI, University of Nairobi and Egerton University carried out research on feed rationing and socio-economic studies related to prosopis. RAE Trust facilitated the community in Salabani to plant *Cenchrus ciliaris* pasture grass in areas cleared of prosopis and also bought prosopis poles from the community. The Provincial Administration mobilised the local community members and later, in collaboration with KFS and the Charcoal Burners

and Producers Association, coordinated the issuance of charcoal licenses to traders. The Community Museums of Kenya, middlemen, charcoal burners and the local traders also played various roles. The largest stakeholder group comprised the community members, whose capacity was strengthened by the other stakeholders, most notably by KEFRI and a community FFS later transformed into the Charcoal Burners and Producers Association.

5. ***Continuation of activities and further dynamics (2007 to present)***: By 2007, the perception of the community towards prosopis as “devil’s weed” had changed to prosopis as their “gold/coffee” (cash earner) after the exposure to the potential products and this has persisted to date. Prosopis management, especially through charcoal burning, has become a significant source of revenue to the people. Additional efforts by other stakeholders such as the Kerio Valley Development Authority (KVDA) are being made to upscale the proper management and utilisation of the prosopis tree. The KVDA has come up with other ventures such as honey production, is giving beehives to interested community members and plans to have the honey branded as prosopis honey to fetch a premium price.

Innovations and lessons learnt

Various technical and socio-organisational innovations emerged and included revision of the charcoal burning act by the KFS, pruning young trees leading to strong and fast-growing trees for charcoal, posts, timber floor tiles and carvings, and using pods as source of high-sugar-content feed for livestock during the dry season. In some instances, pods were harvested and sold to neighbouring areas, where the tree did not grow. The community found that, when cutting the prosopis trees to replace them with pasture grass, burning the stumps with a fire fuelled by dry cowdung killed the stumps so that the tree did not regrow. An integrated approach to managing prosopis led to changes in the socio-economic situation of the local people, thus changing their attitude to regard the tree as desired rather than despised.

Lessons learnt were that adjusting a policy environment can support an intervention and private-sector participation can ensure that an innovation is linked to the market for relevance and acceptance. It was also apparent that socio-economic gains can override cultural perceptions. From this case, it was concluded that a legal framework should be put in place to regulate the charcoal industry, including setting and enforcing standards. Transfer of traditional knowledge on the uses and values of any tree species should be ensured to understand and handle unforeseen eventualities, and fora should be created to share experiences between communities.

References

- Chengole M & Sang J. 2006. Farmer perceptions and the impact of *Prosopis* spp on food security in the lowlands of Baringo District. Paper presented in 10th Biennial KARI Scientific Conference and Kenya Agricultural Research Forum, 8–12 November, Nairobi.
- Choge SK, Ngunjiri FD, Kuria MN, Busaka EA & Muthondeki JK. 2002. The status and impact of *Prosopis* spp in Kenya. Unpublished report, Kenya Forestry Research Institute and Forest Department.
- Kenya Law Reports. 2006. Charles Lekuyen Nabori and 9 others vs Attorney General and 3 others. Petition 466 of 2006.
- Michieka RW. 2004. Prosopis: a weed threatening the Kenyan dry lands – a letter from a concerned scientist on a terror weed. *Standard* July 10.
- Wasonga VO. 2009. *Linkages between land use, land degradation and poverty in semi-arid rangelands of Kenya: the case of Baringo District*. PhD thesis, University of Nairobi.

The JOLISAA project was funded under European Commission FP7 Grant Agreement 245319. The opinions expressed herein are the sole responsibility of JOLISAA. More information on JOLISAA can be found at www.jolisaa.net

Navigating power dynamics in innovation platforms: lessons from the Blue Nile Basin, Ethiopia

Beth Cullen^{1*}, Zelalem Lema¹, Josephine Tucker², Katherine Snyder³ and Alan Duncan¹

¹ *ILRI, Nile Basin Development Challenge, Addis Ababa, Ethiopia*

² *Overseas Development Institute (ODI), Water Policy Programme, London, UK*

³ *IWMI, Nile Basin Development Challenge, Addis Ababa, Ethiopia*

* Corresponding author. Email: b.cullen@cgiar.org

Abstract

Innovation platforms (IPs) are increasingly popular as mechanisms for enabling sustainable agricultural development in developing world contexts. This is due to growing recognition that agricultural change entails complex interactions between multiple actors and must take into account a range of technical, social and institutional factors. The Nile Basin Development Challenge (NBDC) established innovation platforms for improved natural resource management (NRM) at three sites in the Ethiopian highlands. The platforms began in 2011 and are ongoing. The aim was to improve the planning and implementation of integrated NRM by encouraging: joint identification of issues and interventions; better linkages between actors; increased farmer participation in planning; and co-design of interventions.

Experiences with these platforms suggest that careful attention should be paid to power dynamics. In all three NBDC platforms, the following was observed: i) a lack of common understanding about NRM issues between platform members, leading to competing agendas and conflicting ideas about potential solutions; ii) problems in ensuring adequate community representation within platforms, particularly how to ensure that community members were not dominated by more powerful actors; and iii) a need for systematic facilitation to address power imbalances within the innovation system and to work with actors to change these dynamics. NBDC researchers, in collaboration with IP members, experimented with a range of approaches, tools and methods to tackle these issues, with varying degrees of success. This paper outlines some of the power issues that emerged and the methods and approaches that were used to create an enabling environment for innovation to occur.

Keywords: *innovation platforms, power dynamics, participatory methods, facilitation*

Introduction

The Nile Basin Development Challenge (NBDC) project, funded by the CGIAR Challenge Program on Water and Food (CPWF) aims to improve the resilience of rural livelihoods in the Ethiopian highlands through a landscape approach to natural resource management (NRM). Extensive situational analysis revealed a range of challenges to NRM in the selected study sites (Ludi *et al* 2013). Past interventions have largely been top-down in nature and failed to take into account the aspirations, needs, constraints and livelihood realities of farming communities. Planning and implementation processes are not sufficiently coordinated and there is limited communication between stakeholders. Other challenges include lack of farmer organisation, underdeveloped markets, poor infrastructure, limited access to information and inadequate extension. As a result, the success of NRM interventions has been limited.

The NBDC project is based on the premise that the development of integrated strategies by a range of stakeholders that consider technologies, policies and institutions will lead to improved NRM and provide an alternative approach to top-down implementation. Innovation

platforms (IPs) were used as a central mechanism for stimulating new approaches to NRM planning and implementation. An innovation platform is a needs-based network that brings together stakeholders from different interest groups, sectors and organisations to exchange knowledge and resources and take collective action to solve common problems. The decision to use IPs was based on research evidence, which suggested that changing patterns of interaction between resource users was required to improve NRM interventions. Platforms aimed to provide a forum for negotiation and dialogue with the aim of encouraging: joint identification of issues and interventions; improved linkages between actors; increased community participation in planning processes; and co-design of interventions tailored to local livelihoods, environmental conditions and the needs of different stakeholders.

Differences in power between platform members presented challenges for platform facilitation and the resulting interventions. To date, there has been limited analysis of how innovation platforms operate in practice (Nederlof *et al* 2011: 11). This paper aims to highlight challenges that arose because of power dynamics within the NBDC innovation platforms, how these dynamics impacted on platform processes and the methods and approaches that were used to address power inequalities. It is hoped that the lessons may inform future IP and other multi-stakeholder processes.

Materials and methods

IPs were established in three pilot learning sites in Ethiopia within the Blue Nile Basin: Fogera District in Amhara Regional State and Diga and Jeldu Districts in Oromia Regional State. Stakeholder analysis was undertaken before platform inception to identify key actors, relationships between actors and their areas of influence. A similar set of actors was invited to participate in all three sites, including: district administrators, experts from the Bureau of Agriculture, extension agents, researchers from national research institutes, staff from local universities, NGO representatives and community leaders. Because of the prominent role of government in NRM activities in Ethiopia, platforms were dominated by government representatives, both in terms of participant numbers and the amount of power that these participants could exert. Civil society actors were underrepresented and there were no representatives from the private sector. The composition of platform members reflects the broader Ethiopian context and was therefore difficult for facilitators to address.

Initially, NBDC researchers acted as platform facilitators, but facilitation was gradually handed over to local NGOs to encourage local ownership and ensure sustainability. Activities undertaken by platforms were stimulated and supported through an “innovation fund”. Each fund was awarded on the basis of a proposal from platform members, against criteria that interventions should be participatory, evidence-based, tailored to local social and environmental conditions, and cross-sectoral. The innovation funds meant that multistakeholder collaboration could be put into action and provided an opportunity for NBDC researchers to investigate platform dynamics.

Main results

The starting point for each platform was the identification of a commonly agreed NRM issue: unrestricted grazing in Fogera, land degradation in Diga and soil erosion in Jeldu. All three platforms chose to introduce improved fodder as entry point. Government agricultural experts chose the species to suit local agro-ecologies. Three different approaches to implementation were applied to explore factors influencing adoption: backyard fodder development by individuals at household level; planting of fodder on soil and water conservation structures; and area enclosure of communal grazing lands through collective action. Platform members identified long-term visions that included: rehabilitating degraded land by changing grazing practices, introducing new breeds for increased milk production, trading improved fodder seeds for income generation, and using grasses and trees to reduce soil erosion.

Systematic facilitation was required to assist stakeholders to change current practices. NBDC researchers, in collaboration with IP members, experimented with a range of approaches, tools and methods, with varying degrees of success. These included: community engagement exercises using participatory rural appraisal (PRA) tools; participatory video to communicate community views to IP members; participatory modeling and roleplaying game for NRM planning; establishing “subgroups” within the platforms in order to build the capacity of specific stakeholders; and making use of both formal and informal spaces.

PRA tools were used in a series of “community-engagement” exercises to identify and prioritise problems faced by farmers situated across the landscape and to achieve a more balanced representation of issues. These views were then fed back to the platform members and considered during entry-point selection (Figure 1).



Figure 1: Community engagement using PRA

Participatory video was used to empower farmers, who were trained to use video to record their problems and points of view. The resulting videos were shown to platform members to increase their awareness of these issues. This approach was used in Fogera to communicate community concerns about restricting grazing, of which decision-makers were unaware (Figure 2).

Participatory modeling and roleplaying games were used to represent dynamics within the landscape and roles played by different actors. Models simulated NRM strategies and the resulting impacts on households and surrounding ecosystem. The roleplaying element highlighted challenges faced by different actors and brought issues of conflict to the surface so they could be openly discussed. This process enabled platform members to understand linkages between different parts of the landscape (Figure 3).



Figure 2: Participatory video



Figure 3: Participatory modeling/roleplaying game

Subgroups were formed by facilitators to work with specific actors within the platforms to make sure their needs were met. Subgroups gave marginalised members more power within the platform and were also used to build the capacity of more powerful members to work on specific issues, e.g. local administrators did not know how to facilitate participatory planning so a subgroup was created to train them.

Informal spaces. It was not always possible to address power dynamics head-on within formal meetings, so this was often done more informally by facilitators on the sidelines. The best approach depended on the context. In some platforms where issues of conflict were not so pronounced, facilitators could openly prompt platform members to consider power dynamics. However, in other sites, practical engagement and active learning were more effective.

Through the use of these methods, IP members were encouraged to: critically discuss the use and management of resources from a landscape perspective including potential conflicts; better understand the needs/priorities of different social actors within the landscape; facilitate

collective exploration of alternative NRM strategies tailored to biophysical and socio-economic conditions; and evaluate pilot interventions.

Key challenges met

A number of challenges were encountered along the way that can offer valuable lessons:

- ***More powerful platform members can dominate.*** This may result in the agendas and perspectives of the more powerful being prioritised and acted upon, whilst further marginalising weaker members. In all three NBDC platforms, priority issues selected by farmers focused on immediate livelihood issues, whereas decision-makers focused on longer-term NRM concerns. This led to conflict over the prioritisation of issues and solutions. Facilitators realised that, if government agendas dominated the process, it was likely to lead to lack of “buy-in” by community members, essential for the success of NRM interventions. During the first year, farmers were largely seen as implementers but, during the second year, facilitators were able to encourage farmer involvement in the co-design of interventions.
- ***Group diversity may not be reflected.*** Farmers differ considerably in terms of livestock holdings, land size, wealth, livelihood strategies, knowledge, priorities and needs. Initially, IPs included only a limited number of farmers and failed to represent the overall diversity within the local communities. Furthermore, government officials chose the farmer representatives who participated in the platforms: they often selected farmers who would reflect government agendas or concerns, rather than the views of the wider community. Deeper engagement and broader farmer participation during the second year of interventions helped to rectify this to some extent.
- ***Different types of knowledge are not equally valued.*** Differences in power can influence whose knowledge is selected and shared. Initially, farmer knowledge was not valued during platform discussions. During early platform meetings, decision-makers frequently complained about farmer ignorance of key issues, their lack of knowledge of NRM, backward or inappropriate farming practices and short-term visions. This did not create a favourable environment for the sharing of farmer knowledge and represented a major barrier to innovation. Facilitators explored methods that would assist farmers to express their knowledge and encourage decision-makers to re-evaluate their attitudes.

Key lessons and recommendations for research, policy and practice

Skilled facilitation using the approaches outlined above was critical for the success of NBDC platform activities. Facilitators played a mediating role and helped platform members reach compromise on key issues. This required an understanding of the local social and political context, the ability to identify power dynamics (which are not always obvious) and to draw on knowledge of the farming system and research evidence to help members see that their issues and concerns were often interconnected.

The platforms were initially facilitated by “outsiders” and gradually handed over to “insiders” (platform members). However, it can be hard for insiders to navigate power dynamics because they may be part of the existing power structure. In such situations, an independent outside facilitator who is not part of local power relationships may be required, particularly if facilitators need to advocate on behalf of less powerful platform members.

The combination of different participatory tools, methods and approaches can play an important role in assisting stakeholders to consider issues of representation, participation and power within innovation platform processes and to help create an enabling environment for innovation. However, this may not lead to long-term change, particularly if there are larger-scale structural issues that create barriers to innovation. It is clear that transforming attitudes and ways of working is a long-term process. For meaningful change to take place, such

activities need to be conducted through continuous engagement with an emphasis on building capacity of local actors.

Conclusions

If power dynamics are not acknowledged and addressed within IP processes, this may affect: the priority given to issues, the selection of entry points, and the design and adoption of interventions. There is therefore a danger that, while platforms give the illusion of participation, they may in fact replicate and reinforce existing dynamics rather than enable innovative solutions.

References

- Ludi E, Belay A, Duncan A, Snyder K, Tucker J, Cullen B, Belissa M, Olijira T, Teferi A, Nigussie Z, Deresse A, Debela M, Chanie Y, Lule D, Lema Z, Berhanu A & Merrey DJ. 2013. Rhetoric versus realities: a diagnosis of rainwater management development processes in the Blue Nile Basin of Ethiopia. Colombo, Sri Lanka: CGIAR Challenge Program on Water and Food (CPWF).
- Nederlof S, Wongtschowski M & Lee F van der (eds). 2011. *Putting heads together: agricultural innovation platforms in practice*. Amsterdam: Royal Tropical Institute (KIT).

For more information about the Nile Basin Development Challenge, see www.nilebdc.org

ASARECA: Working with national agriculture research systems to build capacity for agricultural innovation systems in Eastern and Central Africa

Leonidas Dusengemungu¹, O. Ndayitegeye¹, J. Methu² and D. Akishule²

¹ Rwanda Agriculture Board, Kigali, Rwanda

² ASARECA (Association for Strengthening Agriculture Research in Eastern and Central Africa)

* Corresponding author. Email: leonidasdusenge@yahoo.com

Abstract

Since 2008, the Association for Strengthening Agricultural Research in Eastern and Central Africa (ASARECA) has embraced the Agricultural Innovation Systems (AIS) approach as a strategy for enhancing the uptake of technologies for agricultural research and development in Eastern and Central Africa. ASARECA also supports research in the subregion through a competitive grant system and all supported projects are expected to demonstrate the incorporation of AIS principles in their activities. In addition, ASARECA strives to build the capacities of national agricultural research systems through different initiatives, which include various trainings and innovation platform establishment. The process of establishing an innovation platform (IP) involves meeting with district leaders to introduce the AIS approach, meetings with key partners for stakeholder mapping, needs assessment, prioritisation of issues, development and implementation of an action plan, and monitoring and evaluation of activities. In the last three years, over 200 researchers and development stakeholders have been trained on the AIS approach, while 80% of ASARECA-supported projects have adopted AIS principles. Some of the beneficiaries of the mentioned capacity-building initiative have helped to set up IPs in their respective countries. As an example, the first author in this paper has initiated the development of 14 IPs that are benefiting 1587 individuals in different value chains in Rwanda. The IP stakeholders, including local leaders, farmers, cooperatives, seed multipliers, input suppliers, processors, traders, credit service representatives, researchers and extension officers, meet at regular intervals to discuss and implement value-chain interlinked activities. However, there are few researchers skilled in integrated approaches to development, and rigid institutional structures hamper interactions. There is a need for a good number of social scientists able to lead the social components of the AIS approach in Africa.

Keywords: *agricultural innovation systems, innovation platforms, linkages, markets, stakeholders*

Introduction

Adoption of the Agricultural Innovation Systems (AIS) approach is in line with regional efforts to mitigate hunger and poverty in Africa. The Association for Strengthening Agricultural Research in Eastern and Central Africa (ASARECA) is a non-political organisation of the National Agricultural Research Institutes (NARIs) of Burundi, Democratic Republic of Congo, Eritrea, Ethiopia, Kenya, Madagascar, Rwanda, Sudan, Tanzania and Uganda. It aims to enhance regional collective action in Agricultural Research for Development (AR4D), extension, training and education to promote economic growth, fight poverty, eradicate hunger and enhance sustainable use of resources in the Eastern and Central Africa (ECA) region (ASARECA 2012). On one hand, the success of AR4D programmes is affected by how well the practitioners develop an implementation framework that adequately engages all stakeholders and how well relevant knowledge and information

are exchanged and applied. On the other hand, the dynamic changes taking place in Africa's increasing population call for renewed efforts in food production, natural resource management and protection of the environment.

Over past decades, AR4D agencies used different approaches: the linear technology-transfer approach in the 1950s, the farming systems perspective in the 1970s and the farmer participatory approaches in the 1990s. All these approaches have led to less success than expected. More recently, a new approach based on an innovation systems perspective has been advocated (Hall *et al* 2001, World Bank 2012). This approach appears to have the potential to bring many benefits to enhance development and adoption of technologies. The AIS framework stresses the importance of including stakeholders and making organisations and policies sensitive to stakeholder agendas and demands.

For its part, as one of several African organisations that strive to promote AIS, ASARECA decided to establish innovation platforms (IPs), which are increasingly becoming the engine of agricultural development (Makini *et al*, in press). These platforms facilitate dialogue between the main players in the value chain at local or national level: farmers, input suppliers, traders, transporters, processors, wholesalers, retailers, regulators, researchers, extensionists and development agencies. To support the development of these platforms, ASARECA plans to build the capacity of its NARI stakeholders in understanding and applying AIS and value-chain approaches to enhance common understanding and harmonised implementation of its research programmes.

This paper focuses on ASARECA's efforts to disseminate the AIS approach in the ECA region. It brings the key lessons and challenges as well as some recommendations.

Methodology

The study was conducted in ASARECA countries in 2013. Grey literature review was mostly used. ASARECA annual reports, website and project documents (2008–13) were intensively consulted about the integration of the AIS approach in its competitive grant system and all supported projects being implemented in the ECA region. In addition, the authors participated in several activities supported by ASARECA, such as project implementation activities, trainings, innovation platform establishment, seminars, field visits or learning events. With that exposure, they observed the physical settings and environmental factors within which the AIS activities took place; such as existing initiatives, local infrastructure and local partners.

Results

The results show ASARECA involvement in capacity building and education for innovation in the ECA region. Different stakeholders are brought together under IPs to transform African agriculture. In different countries, the process of establishing an IP involves meeting with district leaders and relevant stakeholders to introduce the AIS approach, followed by meetings with key partners in a commodity value chain at district level for stakeholder mapping, needs assessment in order to identify priority issues to address, development and implementation of an action plan, launching of the IP and committee setup, consultation meetings, and monitoring and evaluation of the planned activities. The participation of all stakeholders in any given activity is an important part of the approach, ensuring effective targeting of management options and minimising conflicts between various actors.

ASARECA also supports research in the subregion through a competitive grant system: in the corresponding call for proposals, all selected projects are expected to demonstrate the incorporation of AIS principles in their activities. In addition, ASARECA strives to build the capacities of NARIs through different initiatives, which include graduate training, short courses, building capacity in leadership and management, mentoring, infrastructural support and establishing IPs. Over 200 researchers and development stakeholders from the eleven

ASARECA countries have been trained in the AIS approach, while over 80% of ASARECA-supported projects have adopted AIS principles such as establishment of IPs in different countries and regular meetings to assess the progress (ASARECA 2012). In 2008, ASARECA sponsored MSc programmes for 34 young mid-level scientists from the region. The array of Master degree courses included Plant Breeding, Soil Science, Agricultural Information and Communication Management, Research Methods, Range Management, and Agricultural Extension and Innovation (Lindow 2012). Approximately 60 researchers and development workers have gained skills in the AIS approach and value-chain development through MSc training organised by ASARECA and partners. Over five short courses and workshops benefited more than 100 staff members of NARIs (ASARECA 2010). Political support from national governments for the AIS approach is high. Some of the beneficiaries of the above-mentioned trainings have helped set up IPs in their respective countries. For example, from July 2011 to May 2013, IPs were set up in 14 districts of Rwanda and are benefiting 1587 individuals in different value chains. Table 1 presents some of the IPs that have been established with support from ASARECA.

Table 1: Examples of innovation platforms established recently in Rwanda

Project	Objectives	No. of expected beneficiaries	No. of persons involved	Month & year started
Integrated Management of Water for Productivity and Livelihood Security under Variable and Changing Climatic Conditions in Bugesera and Nyamagabe Districts	Identify farmer practices to cope with climatic conditions and design appropriate management strategies for improved water productivity and livelihood through IPs	200	81	July 2011
Outscaling Banana Xanthomonas Wilt (BXW) Control in Kayonza and Gisagara Districts	Scale out recommended BXW control technologies and innovations in affected communities and enhance availability of information on management of BXW	3600	616	Sept 2012
Developing Community-Based Low-Cost Tissue Culture (LCTC) Innovations for Improved Food Security and Livelihoods in Gicumbi, Muhanga and Nyamagabe Districts	Identify major actors on LCTC value chain and organise them into alliances to scale out LCTC innovations	220	118	June 2012
Utilisation of Bean Innovations in Northern, Eastern, Southern and Western Provinces of Rwanda	Organise stakeholders for uptake of bean technologies through IPs	1200	160	April 2013
Improving Beef Cattle Productivity for Enhanced Food Security and Efficient Utilisation of Natural Resources in the Lake Victoria Basin in Nyagatare and Kirehe Districts	Identify limiting factors in beef cattle production in order to establish strategies for improved productivity	400	98	Sept 2012
Integrated Soil Fertility Management (ISFM) in Kamonyi and Bugesera Districts	Establish IPs for conservation agriculture and outscaling ISFM technologies and innovations	480	160	Dec 2012

It is important to mention that other international initiatives such as the Forum for Agricultural Research in Africa (FARA) and Strengthening Intensification of Maize-Legumes in Eastern and Southern Africa (SIMLESA) are also promoting agricultural IPs in Rwanda. In that junction, the IP approach is giving credence to the Rwandan agriculture sector. It has facilitated the articulation of increased demands by farmers for technologies and technical support from researchers and development workers. In the ASARECA countries, most of the stakeholders have shown high levels of enthusiasm for the new approach. In one IP where farmers were asked to list benefits they gained from their participation in these institutional arrangements, they confirmed that they stopped mixing crops on one field and mixing varieties of beans in one sack (ASARECA 2013). As a result, their income rose twofold. Several innovations are emerging from implemented projects and illustrate how different stakeholders are moving from traditional ways of doing things to new ways. For example, in the Gataraga Innovation Platform (Northern Province of Rwanda), improved packaging with banana leaves is being used to sell Irish potatoes in Kigali supermarkets (Figure 1). This new way of packaging helps farmers gain better prices and hence increase their income.



Figure 1: Gataraga IP farmers can sell Irish potatoes for better prices in Nakumatt supermarket, Kigali, Rwanda

Key challenges

The following challenges have been faced in operationalising the AIS approach in ASARECA: i) limited number of researchers (facilitators) skilled in integrated approaches to development such as AIS in the subregion; the majority of researchers in NARIs are biophysical scientists and not trained to bring together big numbers of stakeholders; ii) limited number of social scientists able to lead the social components of the IP approach; iii) inadequate funding for projects and short-, middle- and long-term training; many projects are being funded on a short-term basis without real impacts; and iv) rigid organisational structure of research institutions; some of the institutions rely largely on the component-based model of doing research, with little interaction between the different units and local partners.

Key lessons and recommendations

Operationalising the IP requires establishment of functional and strong linkages, where all actors' interests are taken into consideration. With its roots in innovation systems theory, the innovation platform is a good vehicle for implementation of the AIS concept. There is an encouraging indication that the AIS approach will succeed, given the strong support by the leadership at all levels, including the community, NGOs, local and central government leaders and research managers. However, the AIS work has until now been fully sponsored by ASARECA. Hence, it could pose challenges in the scaling out and up of the IP activities since the various stakeholder groups may develop a dependency syndrome instead of forming self-sustained and self-funded IPs through local ownership of activities. Furthermore, IP activities call for a good number of facilitators able to lead the social components of the AIS approach in Africa. Based on what has been done, ASARECA wants to scale out successful technologies and innovations with public-private partnerships, but there is need to investigate more the opportunities in order to strategise for enhanced uptake of the AIS approach.

References

- ASARECA. 2010. ASARECA working in partnerships towards the achievement of NEPAD's agricultural agenda (CAADP) Pillar IV and the Millennium Development Goals, Entebbe, Uganda, retrieved on the Website www.asareca.org consulted 15/5/2013.
- ASARECA. 2012. What are they doing, where? Tracing ASARECA/SCARDA MsSc scientists, Published by ASARECA on 2012-09-26 16:21, www.asareca.org, visited on 1/10/2012.
- Dusengemungu L. 2013. Annual report 2012–2013. Kigali: Rwanda Agriculture Board (RAB).
- Hall AJ, Sivamohan MVK, Clark NG, Taylor S & Bockett G. 2001. Why research partnerships really matter: innovation theory, institutional arrangements and implications for developing new technology for the poor. *World Development* 29 (5): 783–797.
- Lindow M. 2012. Building the foundation for research in Rwanda, RUFORUM Case Studies, www.ruforum.org/a/resources/article/download/66, visited on 18/9/2012.
- Makini FW, Kamau GM, Makelo MN & Mburathi GK. 2013. A guide for developing and managing agricultural innovation platforms. Draft submitted to Australian Centre for International Agriculture Research (ACIAR), Australia.
- World Bank. 2012. *Agricultural innovation systems: an investment sourcebook*. Washington DC: World Bank.

No see, no hear, no talk – a three-monkeys fable in the ARD triangle: the agrofishing “hwedo” system of the Ouémé floodplain (Bénin)

Anne Floquet^{1*}, Roch Mongbo¹, Gbelidji Vodouhê¹ and Freddy Houèdokoho¹

¹ *Faculté des Sciences Agronomiques, University of Abomey-Calavi, Bénin*

* Corresponding author. Email: anneb.floquet@gmail.com

Abstract

In the southern part of the Ouémé floodplain in Benin, West Africa, an agrarian community developed over the last century finetuned fishing techniques into a so-called “hwedo” system, by digging drainage channels and blind trenches where fish could be trapped by flood recess. The dominant discourse among development agencies and decision-makers concerning inland-waters fisheries is that continental waters are depleted and that “traditional” fishing cannot feed a growing population. For most Benin extension agents, *hwedo* are unproductive, archaic and about to disappear. At the same time, agrofishers spend fair amounts of money purchasing small plots in those floodplains and build new *hwedo*. They even adjust their *hwedo* system to take advantage of a growing market for off-season food crops and vegetables. The main trenches dug by the ancestors are still harvested for fish but small perpendicular trenches are built, creating a set of raised beds that allow further cultivation when the flood starts and some earlier cultivation by flood recess. The main objective is to cultivate crops with a longer cycle; fish trapping is secondary. Half of the national chilli pepper production is done in this area. Nevertheless, such innovations remain invisible and very little support is provided to these producers. Input-intensive aquaculture and rice farming are more fashionable than open-ended joint research on local innovation processes that show good promise of efficiency and sustainability.

Keywords: *agricultural research and development triangle, agrofishing system, farmer-to-farmer extension, floodplains, indigenous innovation, low-external-input farming*

Introduction

The invisibility of local innovations has been attributed to several factors. Embodied in practical knowledge and skills rather than in science-based inputs, they induce incremental changes and do not intend to bring about any “breakthrough”. Many of the indigenous innovations are locally specific procedures and adjusted to specific sets of natural resources. Upscaling is based on spreading their principles and parts of their related know-how – which is not codified but consists of a flexible set of rules, correlations and practical skills, rather than of transferring and appropriating tangible inputs. As Paul Richards put it when explaining why farmers in wetlands in Sierra Leone did not engage in irrigation systems, equipment has to be kept light and conceptual frameworks have to be flexible in risk-prone environments (Richards 1989, 1995). Indigenous innovators are often poorly linked to the formal economy and to agricultural research and development (ARD) organisations and are therefore overlooked in typical surveys and assessments; adoption surveys are not designed to capture their achievements. When local innovators develop tangible inputs (seeds, breeds, phytopharmaceuticals for pest control), these are common goods – therefore, the formal private sector has little interest in diffusing such innovations.

Last but not least, local innovators will often not get revenue from innovating. Markets may not be organised to absorb surpluses or products of a better quality and higher price. Therefore, local innovators are not necessarily the better-off producers. In fact, many local innovations are developed by the poor with access to neither external inputs nor secure

markets. Several studies have been conducted on innovations developed by producers in order to cope with land scarcity and fertility depletion in West Africa and specifically in Benin (Floquet 1994, Saidou *et al* 2004). Nevertheless, in their daily work, researchers and extension agents hardly take notice of indigenous innovations, while producers do not bother mentioning them. It is a “no see, no hear, no talk” vicious circle. In studying local innovation processes in agriculture in Africa, we decided to avoid such myopia and to keep an equal eye on externally triggered as well as local innovations.

Materials and methods

JOLISAA (JOint Learning in Innovation Systems in African Agriculture) is a research project on innovation processes in agriculture. In Benin, an indigenous fishpond system was selected for in-depth studies: it spreads over the lower part of the Ouémé River and concerns thousands of farming families. We expected to find innovative changes in the system. A team of agronomists explored the valley from the lagoon into which the river flows, its lower and higher delta, up to the area where the valley narrows when entering the basement complex. The team conducted 35 semistructured interviews among extension agents and fishers and selected three places along the river for further interviews among different types of fishers, using a framework that was common to all JOLISAA teams (Floquet *et al* 2013).

Main results

In the southern part of the floodplains where the study was conducted, a very dense net of channels has been dug and maintained over decades in order to trap fish by flood recess and drain lowlands as fast as possible in order to cultivate. Some channels are linked to the river but most are blind. Blind channels are locally called “*hwedo*”. This system is even more intensively managed nowadays since urban markets are demanding vegetables and off-season crops. Therefore, fishermen focus increasingly on lowland cultivation and are building a new dense net of auxiliary small channels perpendicular to the former longer ones (Figure 1 and 2). While being dug, secondary channels allow for plant beds to be raised; significant areas are made available for high-value crops with a longer growth cycle, such as chilli peppers (Kpadonou 2010; Kpadonou *et al* 2012).



Figure 1: New adjustments in *hwedo* through a net of perpendicular smaller channels and elevated beds

A range of cultivation techniques take advantage of the mulch produced by the huge amount of aquatic weeds in the ponds, which is removed at fish-harvest time and spread on the beds (Figure 3). Interannual variations in the height of the floods are wide; there are years when the water recedes late, other years when upper beds remain dry and when crops are relocated on the fishpond grounds. This is a first step in adjusting to an increasing climatic variability.



Figure 2: Net of freshly built smaller *hwedo* and adjacent raised beds (*kanfli*)



Figure 3: Aquatic weeds removed before fish harvest are spread as mulch on adjacent dikes

Little has been done to help producers to cope better with the variability and unpredictability of the farming circumstances (especially water availability) as well as with the system drudgeries. Only recently have a few experiments been conducted on how to raise catfish for

a second harvest in the ponds (Imorou Toko 2007). The transformation of the *hwedo* from fishing to an aquatic agricultural system has hardly been acknowledged by formal ARD organisations. There is no dataset for assessing the performance of the whole system and its economic contribution. We assume it to be quite high, which is attested by the fact that, according to surveys (e.g. Kpadonou 2010), one third of the male farmers have purchased plots in the valley.

Key challenges met

The situation encountered here consists of typical innovations evolving “below the radar” in the informal economy. They do not fit into the State development priorities, which focused on rice in irrigated schemes (supposed to expand in the valley over 1000 ha between 2001 and 2010 but actually reaching less than 200 ha). They do not fit with priorities in fisheries either, which focus on “modern” aquaculture. Current efforts to promote rice and fish farms contrast with the lack of support to vegetable production on *hwedo* beds and to the extensive fish-raising in the channels. Producers have therefore benefited little from formal ARD. Most extension agents and decision-makers in Benin nowadays regard the *hwedo* system as unproductive, archaic and bound to disappear. Surveys among producers confirm that the share of farmers supported by extension tends to zero (Singbo *et al* 2008).

Key lessons and recommendations for research, policy and practice

In complex and flexible farming systems developed in difficult environments such as agricultural aquatic systems or drylands, most available technologies from research do not match or at least are not transferable without adjustments. Supporting local innovation processes will be a more efficient strategy and a good way to begin collaborative innovation design and development. In an early stage, much could be learnt from producers on how they manage the system, before new ideas and inputs are introduced on local demand.

As a group with a common historical background and language, producers in the valley are used to communicating among themselves rather than with external agencies. At the same time, they suffer from seasonal inaccessibility, low asset base, poor health and food insecurity, and have poor links to wider sources of information needed for market access and innovation. The producers therefore deserve support to further improve their innovations and gain access to new knowledge and market resources. Changes in water and rainfall regimes from year to year also have to be taken into account. In spite of its technical potential, their system is constrained by issues of tenure, fishponds being locally considered as commons and prone to petty thefts. Intensive demand-driven collaborative research with producers will be required to develop adequate solutions and recommendations.

Conclusions

In order to get out of the “no see, no hear, no talk” vicious circle, the rationale for the *hwedo* agricultural aquatic system and its performance must be assessed and made visible to a broad audience. Performance assessment in risk-prone environments requires a systemic perspective of the system beyond boundaries of disciplines. Learning first from farmers is also a good base for further joint learning and collaborative research. The organisation of research and even more of extension is currently not flexible enough to respond swiftly to producers’ needs. New arrangements will have to be found for long-term sustainable financing and promoting of joint research and demand-driven extension for such specific groups and environments.

References

- Floquet A. 1994. *Dynamique de l'intensification des exploitations au sud du Bénin et innovations endogènes: un défi pour la recherche agronomique*. PhD thesis, Faculty of Agricultural Sciences, University of Stuttgart-Hohenheim, Germany.
- Floquet A *et al.* 2013. Le *hwedo* dans les systèmes agro-piscicoles de la vallée inondable de l'Ouémé au Bénin, Abomey-Calavi, Bénin. Cotonou: JOLISAA-Bénin, Université Abomey-Calavi.
- Imorou Toko I. 2007. Amélioration de la production halieutique des trous traditionnels à poissons (whedos) du delta de l'Ouémé (sud Bénin) par la promotion de l'élevage des poissons-chats *Clarias gariepinus* et *Heterobranchus longifilis*. PhD thesis, Facultés Universitaires Notre-Dame de la Paix, Namur, Belgium.
- Kpadonou RAB. 2010. Impact de la contrainte de crédit sur la production et le revenu agricoles: une analyse par la programmation stochastique discrète des exploitations agricoles de la basse vallée de l'Ouémé. Thèse d'Ingénieur Agronome, Université de Parakou, Bénin.
- Kpadonou RAB, Adegbola P & Tovignan S. 2012. Local knowledge and adaptation to climate change in Ouémé Valley, Benin. *African Crop Science Journal* 20 (2): 181–192.
- Richards P. 1989. Agriculture as a performance. In: Chambers R, Pacey A & Thrupp LA (eds), *Farmer first: farmer innovation and agricultural research* (London: Intermediate Technology Publications), pp39–43.
- Richards P. 1995. The versatility of the poor: indigenous wetland management systems in Sierra Leone. *GeoJournal* 35 (2): 197–203.
- Saidou A *et al.* 2004. Sustainable soil fertility management in Benin: learning from farmers. *NJAS – Wageningen Journal of Life Sciences* 52: 349–369.
- Singbo A, Nouhoeflin T & Assogba-Komlan F. 2008. Facteurs socio-économiques déterminant la lutte contre les ravageurs des légumes en zones urbaines au Sud Bénin. In: Parrot L (éd.), *Agricultures et développement urbain en Afrique subsaharienne: environnement et enjeux sanitaires* (Paris: Harmattan), pp19–29.

The JOLISAA project was funded under European Commission FP7 Grant Agreement 245319. The opinions expressed herein are the sole responsibility of JOLISAA. More information on JOLISAA can be found at www.jolisaa.net

Models in innovation studies: a critical reflection based on comparison of four innovation processes in Benin

Anne Floquet^{1*}, Simplicie Davo Vodouhé¹, Jolanda van den Berg², Cocou Rigobert Tossou¹, Bernard Triomphe³ and Roch Mongbo¹

¹ *Faculté des Sciences agronomiques, Université Abomey-Calavi, Bénin*

² *Agricultural Economics Research Institute (LEI), Wageningen UR, Netherlands*

³ *CIRAD UMR Innovation, Montpellier, France*

* Corresponding author. Email: anneb.floquet@gmail.com

Abstract

In the context of the EU-funded JOLISAA (JOint Learning in Innovation Systems in African Agriculture) project, four local innovation processes involving smallholders in Benin were selected for in-depth assessment: innovation in *hwedo* agrofishing, integrated soil fertility management (ISFM), rice parboiling and soy value chains. Stakeholders directly involved in the innovation process were interviewed. As alternative to the currently challenged transfer-of-technology model of agricultural research and development (ARD) and in order to develop a framework for process monitoring, this paper presents underlying explanatory/analytical models derived out of lessons learnt from the four case studies, reflecting the main features of and the main drivers behind these innovation processes. The explanatory models are: i) feedback socio-ecological model; ii) pull-and-push innovation-driver model; iii) co-learning and joint selection model; and iv) historical account using the innovation bundle. Each model emphasises specific linkages within complex processes of innovation by smallholders.

The models are not mutually exclusive and should be embedded in a more comprehensive theory-based framework of innovation processes. However, each of them can be used to design operational monitoring and systematic ongoing assessment of innovation in focusing on specific aspects of the innovation process. The innovation-bundle model helps in following innovation sequences over time and making local innovation visible. The co-learning model describes how innovations are identified or designed, adjusted and kept, or dropped. The pull-and-push model helps project designers think of innovation in terms of opportunities for smallholders and not in terms of problems. The feedback socio-ecological model stresses the relationship between changes in the state of natural ecological systems and human actions and institutions. Monitoring would contribute to making the innovation process more visible and providing more adequate support.

Keywords: *agricultural innovation systems, innovation models, innovation monitoring, social learning, agricultural research and development, innovation bundle, Benin*

Introduction

Transfer-of-technology thinking has dominated in agricultural research and development (ARD) agencies over decades and still does. Today, concepts of innovation processes and interactions among stakeholders have been considerably revised and enriched to better depict real-life processes. The innovation systems perspective is one of these new concepts. It takes into account the diversity of actors, their relationships and the interactions involved in the innovation process, including its institutional setup. Despite the richness of observations, there are still methodological issues on how best to assess innovation processes and how lessons gained through assessment can help strengthen agricultural innovation systems (AIS).

This paper is an attempt to present four analytical models of innovation reflecting the main features of the innovation process and its drivers. Such analytical models are useful tools for

conceptualising complex processes by selecting interactions purposefully and represent a striking contrast to the “transfer-of-technology” model.

The models are derived from an analysis of four innovation cases developed in the framework of the EU-funded FP7 project JOLISAA (JOint Learning on Innovation Systems in African Agriculture) in Benin. Innovative practices in the *hwedo* agrofishing system for floodplain management are depicted using an adaptive feedback model; ISFM as a pull-and-push model; soybean development as a bundle of interdependent (induced) technological, organisational and institutional innovations; and rice parboiling as a co-learning and joint selection model. Strengths and limitations of these models are then discussed with the objective of contributing to a more generic framework for capturing smallholder innovation processes.

Materials and methods

The JOLISAA project was designed for a comparative study of innovation systems in African agriculture through case studies. It focused on innovation processes rather than on innovations as end products. Each case study describes in detail how an innovation process has unfolded since the moment where it is triggered by local innovators, ARD agencies, projects or other stakeholders, up to points where some spread becomes noticeable in the landscape outside the direct local context in which the innovation had emerged. It is expected that, at this later stage, non-artificial and more sustainable drivers of change as well as stakeholders contributing to the feasibility and expansion (up- and outscaling) of the innovation can be identified. Innovations were screened on the basis of two criteria: i) the innovation process needs to go beyond early experimental or project-based stages; and ii) more than three categories of stakeholders should be involved in the process.

Innovation processes, stakeholders involved and outcomes were first described using a light framework of analysis based on documentation and exchanges with knowledgeable persons. In Benin, this led to the selection of four cases for in-depth study based mainly on systematic semistructured interviews of a large range of stakeholders involved in the process. The results were discussed with these stakeholders in workshops and presented to policymakers.

The JOLISAA team in Benin selected: i) the *hwedo* fishpond system as an indigenous innovation; ii) ISFM as a process of joint learning through on-farm research by ARD teams and Farmer Field Schools (FFSs); iii) the development of a steam cooker as a success story on cooperation between researchers and women engaged in rice parboiling; and iv) soybean as an innovation that evolved from simple nutritional advice to mothers to a rich bundle of numerous interrelated innovations. In all four cases, the timeframes required to follow the process back to its beginning are long (at least three decades); such timeframes go well beyond most project interventions (Floquet *et al* 2013).

Main results

In the floodplains of southern Benin, producers have for decades dug out channels for drainage after floods as well as to make dead-end ponds where fish could be trapped by flood recess and raised for a few months before being harvested. In response to changes in their ecological and economic environment, these producers recently began to build secondary smaller channels parallel to raised beds where they grow high-value crops. This has given birth to a new agrofishing system. Norms on “how things are done” and local institutions such as access rights to water, land, labour, fish and crop harvests evolved in parallel.

A possible innovation model may draw on systems thinking (Figure 1). Changes in the agro-ecological and economic environment induce human actions for technical and institutional changes, which in return induce changes in the environment. Out of this feedback, human actions are reinforced, adjusted by self-regulation, adaptation, learning or evolution or change targets (e.g. von Bertalanffy 1972, Checkland 1999).

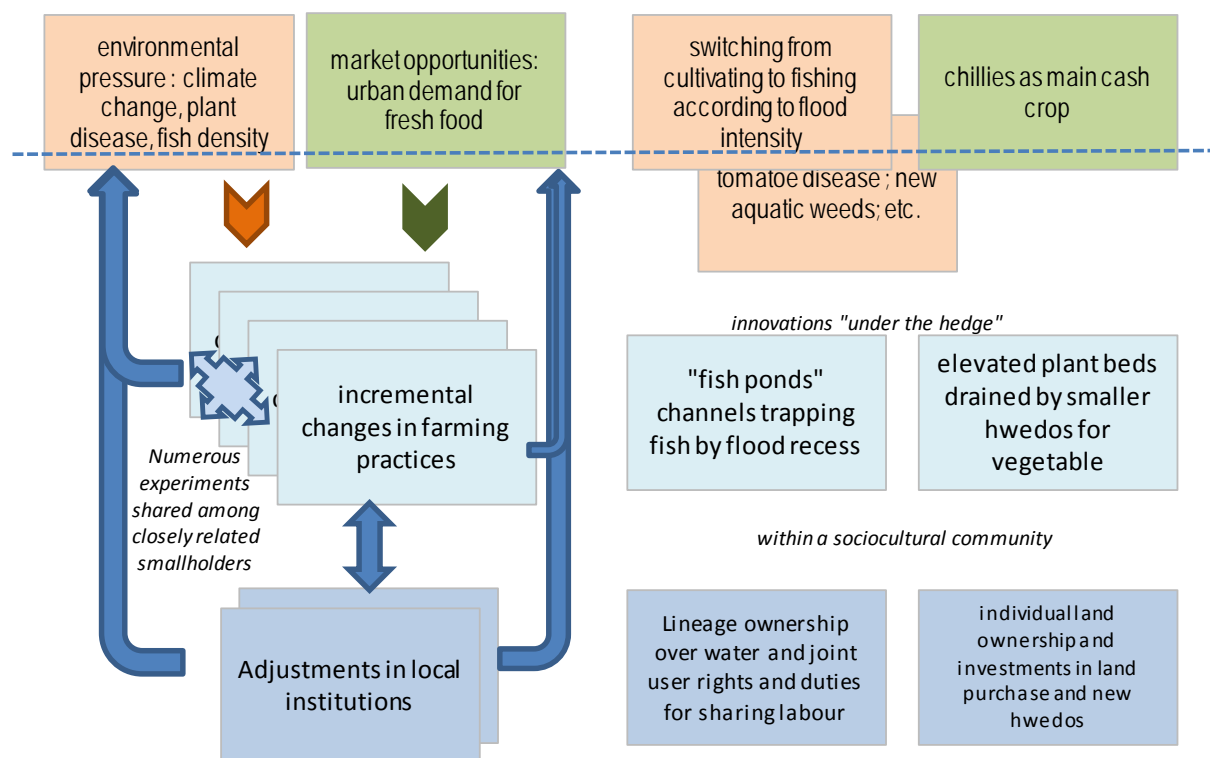

Figure 1: The adaptive model: endogenous innovation in response to changes in the environment of a *hwedo* agrofishing system in a floodplain

Users of natural resources actively shape their natural environment according to their perceptions of the state of this environment and of technical and economic opportunities. It has already been shown in different African contexts that producers actively manage soil fertility (Scoones 2001). Here it is shown how they manage land and water in a context of increasing climatic variability. The better local resource users understand the feedback received, the more adapted their reactions. However, the model does not take into account how such social learning happens.

Integrated soil fertility management (ISFM) has been promoted over recent decades in Africa by research and extension with a range of options developed through on-farm research, participatory technology development (PTD) and FFSs. In Benin, decrease in soil fertility was perceived as a real problem by outsiders as well as producers, but adoption of land-saving technologies such as planted fallows remained low, in spite of the significant efforts put into adjusting them to farmers' circumstances. Adoption occurred only in the context of projects that created access to input and output markets, and generally slowed down after the projects ended. Recently, new trends in adoption of ISFM options have been emerging. They are tied to the development of new markets for high-value crops, such as maize for animal feeding or organic products, which make the additional efforts of farmers economically profitable.

There is a growing consensus in the international ARD community that markets are driving forces for innovation and should be made accessible to the poor, even if the assertion is not new (Griliches 1957). The model (Figure 2) here is a new packaging of the old "technology push-market pull" dichotomy (Coombs *et al* 1987). Instead of focusing on constraints impeding success, the analytical focus is on opportunities that can be grasped by smallholders when innovating.

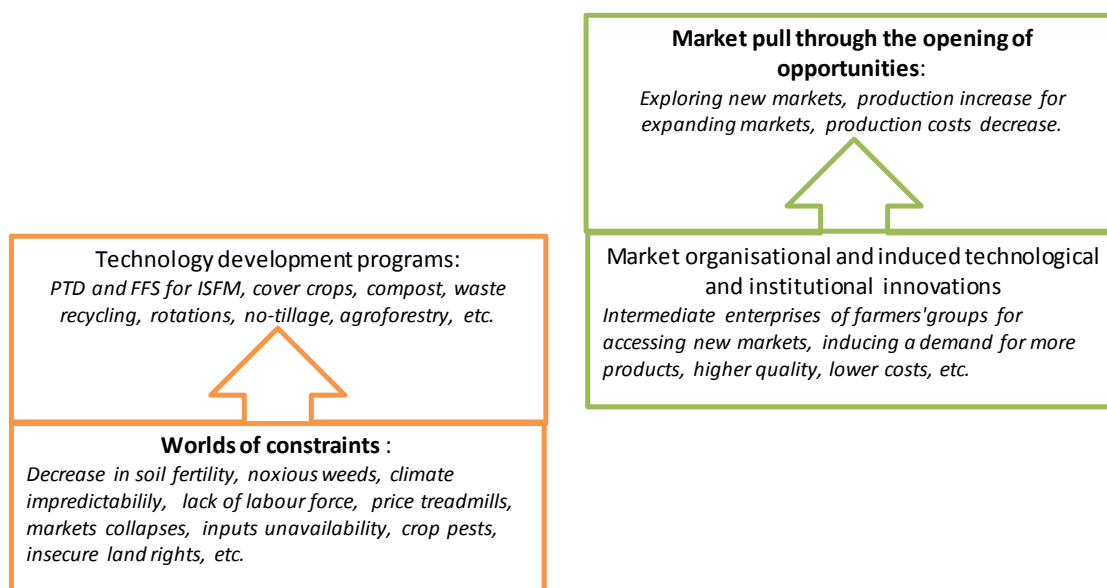

Figure 2: Market-pull model: innovation pushed by constraints or pulled by opportunities in integrated soil fertility management

In the soy case, NGOs first brought nutritional advice for young mothers concerning soy-based baby food. Women began to introduce soy into a wide range of recipes as substitute for more expensive or scarce supplies. A domestic market appeared that was boosted by the food crisis. A stable supply of soy encouraged the large-scale entrepreneurs of edible oil to select it as a substitute for cottonseed. Both types of demand induced development of organisational innovations in supply chains and farming. Technical crop innovations that had remained unacknowledged by farmers raised their demand. In the end, a wide range of stakeholders can be counted in the soy innovation system. Decision-makers took no notice of these processes, which evolved largely “under the hedge” over three decades until soy emerged as the second most important legume in the country. At the outset, such processes could not have been expected. Their outcomes even seem rather unpredictable: had one new development not happened, the pace and shape of the whole trajectory might have been different. The soy case (Figure 3) illustrates how innovation induces innovation. Innovation does not come in isolation but is part of a bundle of technical, organisational and institutional innovative changes.

For example, a technical change requires input and market access for going to scale and smallholders succeed in organising themselves or developing linkages with the private sector. The model says indeed little about the how and why but follows the sequencing of innovations over time.

The rice steam cooker is one of the few success stories in ARD in Benin. The technological change in rice processing is partly embodied in this cooker, which was developed, tested and improved in close cooperation with women engaged in parboiling. Complementary innovation occurred, e.g. in producer-to-producer extension through videos that were used to facilitate village-level meetings (Okry *et al* 2013). Soon, new players entered the game to produce the cooker or purchase the parboiled rice. In a context of increasing urban demand for rice, the market drive and the response from rice farmers were high enough for a second loop to become necessary in order to design and test larger steam cookers (300 kg per process versus 25 kg for the first-generation cooker).

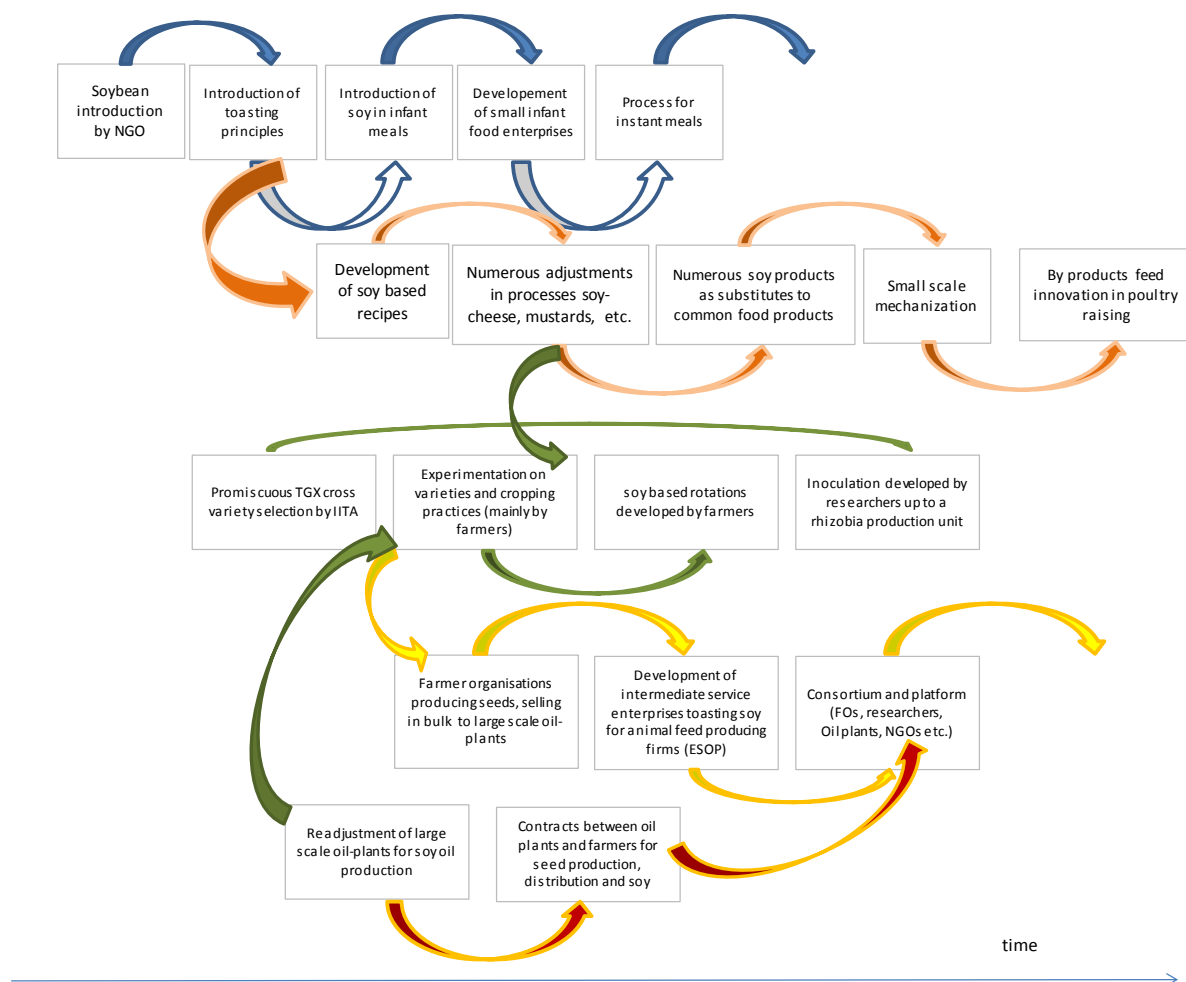

Figure 3: Innovation bundle model: technical, organisational and institutional innovations induce each other within the soy innovation process

Such a process can be designed as a learning selection model (Figure 4). This was first conceptualised by Douthwaite *et al* (2002): promising plausible options are jointly tested and assessed by researchers and innovative producers until they reach a point where the options are either dropped or adjusted and prepared for sharing with a wider range of producers. Important here is that researchers must still follow the evolution of their innovation and be ready to take it up again when new needs emerge (Douthwaite & Gummert 2010).

Key challenges met

The case studies illustrate that smallholder innovation processes are complex in their trajectories, pace and the stakeholders involved. The “transfer-of-technology” model can cope neither with this complexity nor with those innovations that are mainly endogenous (*hwedo*) or result from merging external and local knowledge (soy-based food).

Models derived out of the four cases can help us better monitor innovation processes in smallholder farming. They are not mutually exclusive (Table 1). Each of them contributes to highlight specific sets of hypotheses concerning innovation drivers and their possible changes over time as well as about the sequencing of innovations. Indeed, if innovations do not sequence up, processes may get stuck.

Collective adjustments through learning loops and selection can also be taken into account, either as a local process or a project-based approach with researchers and other stakeholders. Last but not least, the models view innovation processes as continuous and open-ended, with innovation targets being readjusted in the course of the processes.

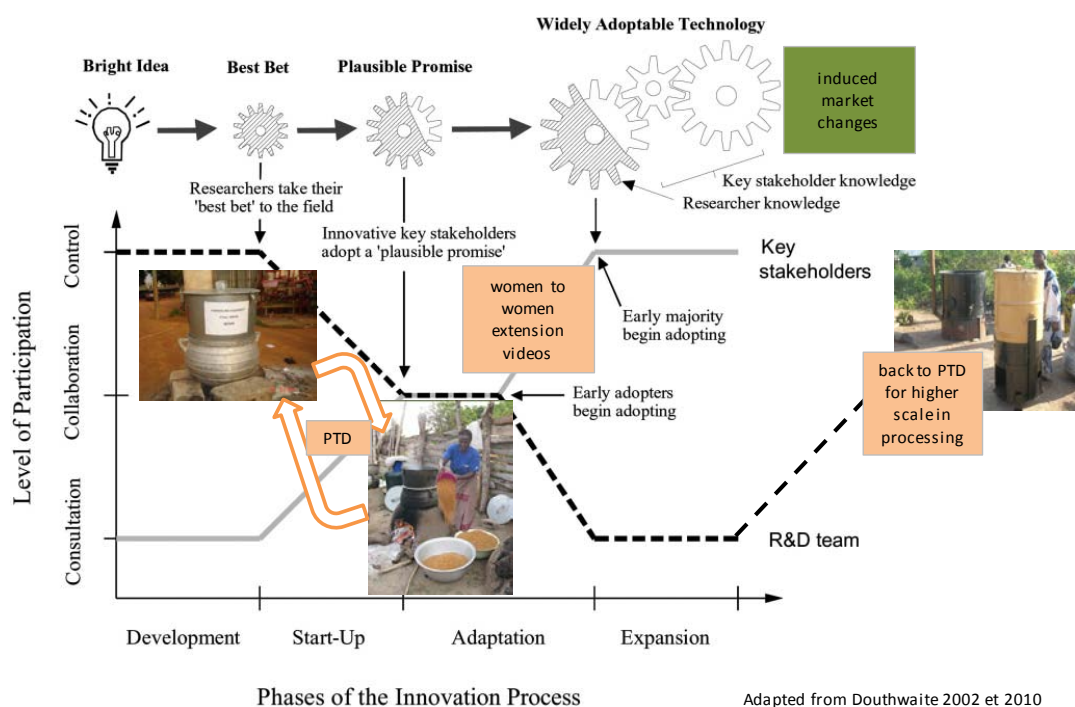

Figure 4: The iterative co-learning and joint selection model in parboiled rice innovation process

Table 1: Comparison between alternatives emerging explanatory models

Alternative emerging models	Main characteristics	Underlying hypotheses about innovation drivers	Strengths	Limitations
<i>Feedback model</i>	Interactions environment-process	Innovation induced by learning about the new state of the environment	Innovation as adjustment to changes in the environment and state of the natural resources	Incomplete cybernetic model
<i>Pull-and-push model</i>	Interactions environment-process and drivers	Market opportunities as better innovation drivers than constraints	Identification of main drivers, especially market drivers	No tool in itself for analysis of opportunities
<i>Innovation-bundle model</i>	Internal sequencing of innovation	Each innovation when evolving induces the need for new one(s)	Sequencing of innovations inducing each other over a long period of time	No tool in itself for process and path analysis
<i>Co-learning and joint selection model</i>	Internal learning process	Upscaling as an outcome of joint innovation and learning induces need for new innovation	Focus on learning processes among researchers and producers	Early search and selection phase in the process; little on the environmental enabling factors

Key lessons and recommendations

Some of the perceived strengths and limitations of these four models are discussed below.

The *adaptive feedback loop model* concerns the adjustments that social groups can design in order to cope with changes in their environment, including both technical actions and institutions governing access rights to the required resources. We first made a simplistic cybernetic model out of the *hwedo* case in order to pinpoint the ability to adjust farming systems to changes in the environment. This is a good tool for entering such situations with an open mind and to monitor interactions between biotechnical and socio-economic systems. Yet, the innovation consists in technical changes embedded in and inducing institutional changes and both types of change allow this group to address environmental and socio-economic challenges. Organisation, adaptation and changes in target all rely on joint learning among stakeholders. These issues are not captured in this model.

The innovation process behind the *co-learning and joint selection model* increases the probability to come to terms with the issue it intended to address. Its focus is on the early stage of a specific innovation. After competing options have been considered, one is selected and adjusted for a better fit. Joint learning improves local smallholders' ability and speed in developing a feasible and profitable technical option. To monitor such a process, the co-learning and joint selection model is quite appropriate. Yet this co-learning model would be reductionist if: i) the only parts of the innovation process taken into account are those where smallholders and external ARD agents come together; and ii) this specific search stage of a specific innovation is not replaced in the whole innovation process. The co-learning and joint selection model may then allow zooming in on the ongoing active learning processes developing in some parts of the bundles and identifying where these are weak.

The *pull-and-push model* questions the efficiency of triggers and drivers to induce and sustain an innovation process. Most innovative options promoted in ISFM in order to tackle constraints did not take root locally and it was unlikely that they would be adapted over time and endure unless they tap opportunities. This is a shift in mindset for project managers used to designing project frameworks out of problem analysis. However, it does not provide clues for the identification of triggers and drivers.

The *innovation-bundle model* comes to terms with the diversity of innovation types developed around a common issue and their sequencing, which allows keeping the momentum or brings the whole process to a standstill. Indeed, innovation processes seem to have unpredictable outcomes but probably within a given domain of possible outcomes. However, at local level, the trajectory is not a product of unpredictable randomness; it is shaped by stakeholders' encounters (and missing ones). In both cases, our models have limitations concerning the way to analyse drivers of changes and innovation trajectories.

Innovation support requires some monitoring capacity and analytical skills about the ongoing process. Processes may remain invisible and changes happen at a very small scale and then scale out rapidly when market opportunities open up, as in the case of soy, where the demand from industrial edible oil and from small-scale soy-processing units added to demand for baby food. For this reason, innovation processes need to be monitored over longer periods of time.

The models developed here can be considered as sub-models highlighting specific types of linkages: i) between innovations and state of natural resources; ii) between innovations and market and economic resource drivers; iii) among interacting innovations; and iv) among stakeholders in a learning and selection process during innovation search. They are complementary and should be included in a more generic analytical framework that could be used for monitoring and benchmarking innovation processes in a more systematic and operational way. Numerous scholars are actively searching for such a generic framework and their contribution may feed our own search. Ostrom (2009) proposes a more generic

framework for analysing self-organisation in socio-ecological systems, with focus on relationships between and within ecological systems dynamics and social systems regulation. Nelson and Winter (1977) designed an economic framework for the innovation search process among entrepreneurs and the selection factors conditioning success or failure of the search. Social scientists developed specific frameworks focused on learning and linkages within agricultural innovation systems seen as “organizations, firms and individuals interacting and contributing towards bringing something new into use” (Klerkx *et al* 2012).

Conclusions

Our case studies show that smallholder innovation is “alive and kicking”, although it often does not take the shape and path expected by ARD agencies. Our cases also allow us to identify specific enabling factors that made innovation possible and some factors that may impede or slow down further development. In the *hwedo* innovation process, smallholders in relatively homogeneous social settings and close interaction with changing natural resources learn how to adjust and reshape their environment and local institutions for a better fit. Their local networks are, however, disconnected from those of external agencies. In the parboiled rice process, joint learning between researchers and women engaged in processing could occur over a long period of time and the development of the steam cooker was a success. But success cannot be attributed solely to such interaction: ISFM also had a long story of actively promoted joint learning between farmers and researchers, yet yielded little success. Market drivers and linkages among smallholders such as small entrepreneurs (mostly women) processing rice and producer organisations and between producers and a wide range of support organisations are also factors for success. Sequencing of innovations, one inducing the need for another, also describes the dynamics in an innovation process. The co-learning model may help understand how innovation develops into a specific trajectory and analyse how trajectories may be re-oriented.

The four innovation models presented here can be used to monitor ongoing innovation processes, by focusing on specific aspects of innovation dynamics. They should, however, be embedded in larger frameworks, which they will help to improve in return. They could be used, for example, in relation to setting up innovation platforms so that not only the functioning of innovation platforms can be monitored but also the innovation processes, which the platforms are supposed to support and enhance.

References

- Bertalanffy L von. 1972. The history and status of general systems theory. *Academy of Management Journal* 15 (4): 407–426.
- Checkland P. 1999. *Systems thinking, systems practice: includes a 30-year retrospective*. Chichester: John Wiley & Sons.
- Coombs R, Saviotti P & Walsh V. 1987. *Economics and technological change*. London: Rowman & Littlefield.
- Douthwaite B, Keatinge JDH & Park JR. 2002. Learning selection: an evolutionary model for understanding, implementing and evaluating participatory technology development. *Agricultural Systems* 72 (2): 109–131.
- Douthwaite B & Geels FW. 2002. Technological transitions as evolutionary reconfiguration processes: a multi-level perspective and a case study. *Research Policy* 31 (8): 1257–1274.
- Floquet A *et al*. 2013. Assessing local innovations: experiences in Benin. JOLISAA country report. Cotonou, Bénin: JOLISAA–Bénin, Université Abomey–Calavi.
- Griliches Z. 1957. Hybrid corn: an exploration in the economics of technological change. *Econometrica* 25 (4): 501–522.
- Klerkx L, Mierlo B van & Leeuwis C. 2012. Evolution of systems approaches to agricultural innovation: Concepts, analysis and interventions. In: Darnhofer I, Gibbon D & Dedieu B (eds),

- Farming Systems Research into the 21st century: the new dynamic* (Dordrecht: Springer), pp457–483.
- Nelson RR & Winter SG. 1977. In search of useful theory of innovation. *Research Policy* 6 (1): 36–76.
- Okry F, Van Mele P & Houinsou F. 2013. Forging new partnerships: lessons from the dissemination of agricultural training videos in Benin. *Journal of Agricultural Education and Extension* 1–21. DOI: 10.1080/1389224X.2013.783495
- Ostrom E. 2009. A general framework for analyzing sustainability of social-ecological systems. *Science* 325 (5939): 419–422.
- Scoones I. 2001. *Dynamics and diversity: soil fertility and farming livelihoods in Africa: case studies from Ethiopia, Mali and Zimbabwe*. London: Earthscan.

The JOLISAA project was funded under European Commission FP7 Grant Agreement 245319. The opinions expressed herein are the sole responsibility of JOLISAA. More information on JOLISAA can be found at www.jolisaa.net

How innovation processes unfold along unexpected trajectories: the case of soy in Benin

Anne Floquet^{1*}, Gbelidji Vodouhê¹, Agnaly Michaud², Bernard Bridier² and S. Davo Vodouhê¹

¹ *Faculté des Sciences Agronomiques, Université d'Abomey-Calavi (UAC), Benin*

² *CIRAD UMR Innovation, Montpellier, France*

* Corresponding author. Email: anneb.floquet@gmail.com

Abstract

Innovation processes may remain unperceived over decades until outcomes become widely visible. This paper depicts the introduction of soy in Benin and the multiple innovative processes resulting from orchestrated interventions as well as non-orchestrated initiatives among many small-scale food-processing units.

Research on this complex innovation process was conducted within the framework of the EU-funded project JOLISAA (JOint Learning in Innovation Systems in African Agriculture). An in-depth study was conducted over a six-month period in 2012 by a team of young agronomists supervised by senior scientists, mainly in three areas where soy is now largely produced and locally processed. In addition to smallholders, many of the other stakeholders involved were interviewed: researchers, oil-mill managers and decision-makers.

The soybean innovation storyline begins in the late 1970s. Over time, a complex bundle of innovations emerged with many stakeholders engaged from farming communities, the private sector and NGOs. It encompassed small-scale food products such as cheese and mustard as well as industrial oil and feedstuffs. Major innovative products and processes concern soy as a substitute in local food for the poor. The innovation is now rooted in local habits and sustains an informal economy. Many linkages have been developed but few with State agencies. Key stakeholders, particularly farmers and small entrepreneurs, receive little support from agricultural research and development (ARD) organisations. Recognition of this innovation process is a real challenge.

This innovation experience illustrates how an innovation process of significant economic importance can remain largely unacknowledged by ARD and State agencies over decades. Trajectories of this innovation process were largely unexpected and could not have been planned at early stages.

Keywords: *agricultural innovation systems, innovation process, induced innovation, social learning, agricultural research and development, innovation bundle*

Introduction

What is innovation? In many cases, innovation centres around a simple item, such as a specific crop variety. However, certain conditions are often essential in order to create an enabling environment for innovation to occur, e.g. to ensure that a variety can be transformed into available seed, cultivated, processed and ultimately demanded by markets. This paper presents and reflects on the introduction of soybean in Benin in the late 1970s and on processes that made an unknown crop turn into a major food source in the country. This description builds on qualitative research conducted in 2012. The main innovation trajectories will be described in relation to evolving value chains. The issue of the invisibility of this innovation over two decades before some large players emerged is addressed.

Materials and methods

As part of the EU-funded JOLISAA (JOint Learning in Innovation Systems in African Agriculture) project, innovation processes were identified that had evolved beyond project timeframes. From some initial case studies, four cases were identified for in-depth study; one of these cases was soybean innovation. At the outset of the in-depth study, researchers were aware that soybean had initially been introduced to Benin in the late 1970s as food for infants. This initiative had been supported by an international NGO, which monitored baby growth, trained mothers and commissioned a few additional studies on possible use of the pulse in local food products. This initiative led to nearly 100,000 ha soybean being cultivated in 2012 to supply oil mills and a booming small-scale processing sector (soy cheese, soy mustard etc). One of the aims of the JOLISAA assessment was to understand how this sector had developed.

A framework common to all JOLISAA case studies was used by a team in Benin composed of young agronomists and senior researchers. The framework put a focus on process (history), linkages (stakeholder mapping), innovation types, nature of knowledge mobilised and how enabling the environment had been. After statistics had been collected and a few key informants at national level had been interviewed, an exploration was conducted in main soybean production areas and three sites were selected for investigations with different types of farmers, small-scale processing entrepreneurs, seed producers and intermediaries collecting soy for industries. Each of the sites had unique experiences and had developed different linkages with soy-based markets and value chains. These included linkages with oil mills, with seed producers and animal-feed entrepreneurs or with small-scale local cheese processing, which was in turn connected to local poultry production (Michaud 2012, Floquet *et al* 2013a). Research results were presented to representatives from the main stakeholder groups, who validated the broad picture and agreed on a set of questions that should be tackled in order to “move forward”.

Main results

The soy case has a long history. In the 1970s, the nutritional status of children and mothers was recognised as a public health issue and an international NGO introduced soy for enriching porridge for infants. Civil servants from health and rural development units were taken on board for broad campaigns, nutritional monitoring and education (Figure 1). Support to social services and food aid that encouraged mothers to take part in monthly monitoring of their babies faded out in the 1990s. This would have resulted in the dis-adoption of soy, had it not been for the long-term commitment of a group of national NGOs. These NGOs had undertaken their own initiatives, including the design of community-based baby monitoring activities and, in parallel, the continuous training of mothers to process soy into a large range of food products for consumption and petty trade (Figure 2). Knowledge on such processing was further shared and locally readjusted through informal women-to-women training resulting in variations in both production processes and products. Innovation unfolded below the radar until the 2008 food crisis brought inexpensive soy food to every urban or rural market (Figure 3).

The integration of soybean in farming systems was encouraged by a growing demand from micro-scale processing units and an emerging sector of small- to medium-size social entrepreneurs engaged in producing ready-made baby food. This, in turn, encouraged national oil factories to shift from processing cotton to processing soy as a way of becoming less dependent on unreliable cottonseed supplies. Securing supply for the national as well as for the Nigerian industry gave rise to a new range of innovations around contracts and trading arrangements, driven by oil mills as well as by producer organisations and their supporting agencies. There were also efforts from both types of stakeholders to identify technical innovations that would increase yields and improve crop quality, particularly new germplasm

and viable seed-multiplication systems. Producer organisations also began to develop intermediate enterprises that targeted animal-feed markets. These included the bulking and toasting of soy pulse, the promotion of small-scale delocalised oil production and the use of byproducts from micro-scale cheese processing as poultry feed. These are innovations of an institutional as well as a technical nature.

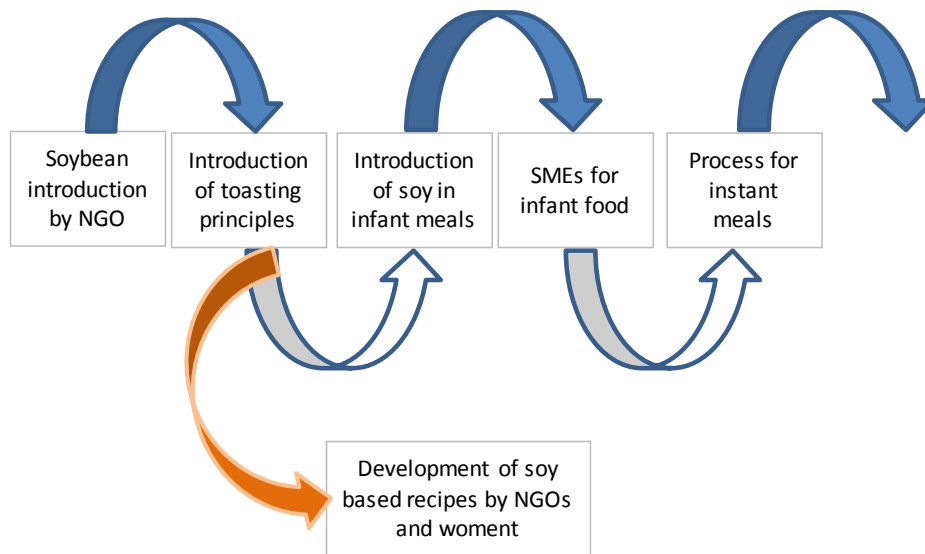

Figure 1: The soybean innovation process in its early stages

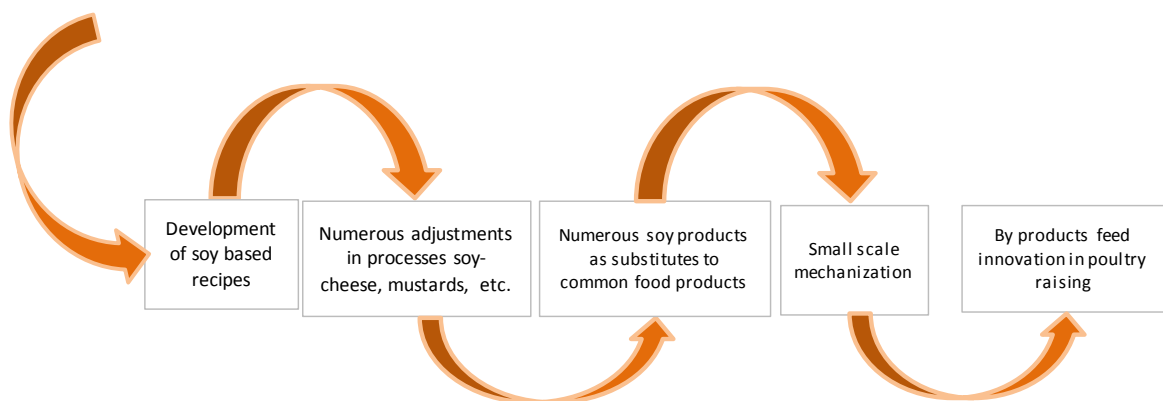

Figure 2: Upscaling in the informal economy

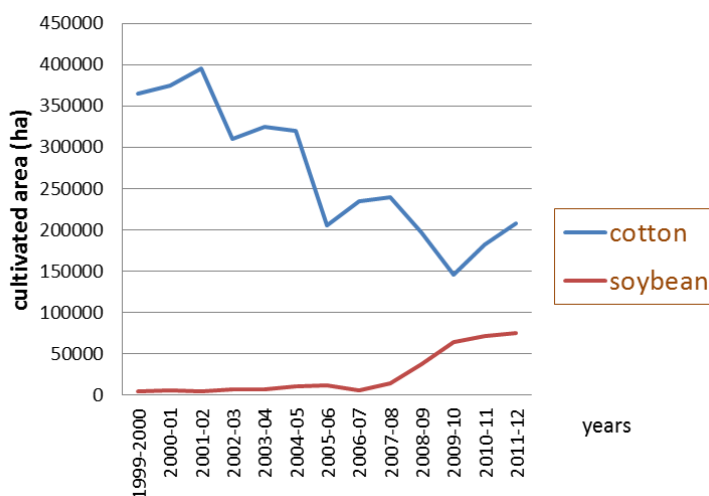

Figure 3: Rapid evolution of soy demand as combined consequence of food crisis and the oil-plant supply crisis

Over time, a complex bundle of innovations emerged that involved many stakeholders from farming communities, the private sector and NGOs. Many linkages have been developed. One significant set of linkages revolved around oil mills, which are focused on securing supply. Other linkages concern soy food mainly produced and traded within short and decentralised value chains. Another set of linkages is built around NGOs engaged in nutrition programmes, which promoted mothers' groups and communal institutions for community-based nutritional monitoring and, as a network, to contribute to lobbying at national level on the need to improve nutrition; some of their retired social workers engaged in medium-scale baby-food units. Some of these NGOs took on brokering functions in the soy trade in order to promote production at good prices. Notably few linkages were built with State agencies and research institutions because they focused on cotton as main cash and export crop and did not see the expansion of soybean. Only recently, now that soy is cultivated on over 100,000 ha, has the crop gained the attention of some decision-makers. However, soy is not yet included in the agricultural strategic plan of the country.

Although soy was introduced from Asia through Nigeria, the knowledge developed is to a large extent rooted in local farming practices and local cooking and food habits. This hybridisation of knowledge gave stability to the innovation process despite the fact that soy cultivation and processing practices may be far from optimal.

Key challenges met

Complexity. The process described here is far from being a single innovation. Numerous innovations chained up in the innovation process – an innovation while unfolding often induced another innovation – and the concept of “innovation bundle” was coined to describe these entangled innovations.

Outscaling. The findings of this research indicate that small-scale innovation processes may well spread significantly. This small-scale innovation could expand rapidly when the environment became conducive because products and processes concerned are targeting consumers at the “bottom of the pyramid”, i.e. those very poor but numerous consumers who reacted positively to cheap substitutes to meat and fish, such as soy.

Invisibility. Such an innovation that had been developed with little involvement of ARD organisations or no longer had support from large development agencies remained invisible over decades. It had been developed by many stakeholders in close cooperation, but they are part of the informal economy or the work of local NGOs, and reports about positive outcomes remained limited or were not noticed by ARD actors. Such innovation processes tend to unfold below the radar through many parallel series of trial and error. They do not receive formal support proportional to their contribution to food security and poverty reduction that might support agronomic research, develop infrastructure and create a supportive policy environment. Researchers and extension agents had little room to develop agricultural programmes for products that are not selected as country priorities. The invisibility of many local innovation processes is a generic feature that has been quoted in other contexts by the Hall *et al* (2006) and Hall *et al* (2010).

Analytical framework for innovation system. Analytical frameworks created for the developed world countries and their formal economies put a focus on linkages between research and development and enterprises (Edquist 2011). Such an “innovation systems” framework does not fit the informal agricultural economies of smallholders.

Key lessons and recommendations for research, policy and practice

Soybean is an appropriate example for depicting how smallholders make use of novelties in unexpected ways. It also confirms the need for long timeframes to be able to monitor how innovations may unfold according to changing circumstances. Trajectories of this innovation process were largely unorchestrated, unexpected and could not have been planned at the early

stages of the initiative. The story begins with the development of one type of product (baby food), which leads to another food product (soy cheese), which in turn contributes to the development of a larger soy supply and production industry. As a general lesson, assessment of innovation trajectories should not be restricted to the one value chain, which may seem to be the most important at a certain point in time, as new products and value chains may emerge unexpectedly. Synergies between such processes encourage innovation.

The soy case shows that the success of soy food products comes from their ability to replace local food products in cooking, whilst being adaptable to traditional cooking methods. Such a lesson deserves to be shared more widely.

These kinds of innovation make a significant contribution to food security and development and therefore deserve policy support. Better monitoring of such innovation processes would contribute to their visibility. Producer organisations could ask universities for such studies and use them for internal strategic planning as well as for visibility and lobbying. In turn, better visibility of the process could trigger engagement in the joint development among concerned stakeholders of much-needed innovations in farming practices, seed production, win-win arrangements for oil-mill supply etc.

Conclusions

Innovation processes that contribute to the enhanced food security of consumers at the “bottom of the pyramid” have been ignored over decades by decision-makers and therefore by national research. This is not the only example. Agrofishing systems with *hwedo* and their innovative changes also remained unseen (see Floquet *et al* 2013b). This research provides an example of innovation processes evolving “below the radar”. This knowledge can perhaps encourage more systematic investigation of smallholders’ innovative efforts in order to inform the coordination and funding of future research for development. In a small country where physical remoteness is hardly a problem, mechanisms should be put into place that facilitate quick mobilisation of human resources and funds in order to be reactive to local and national needs. This is of critical importance at a time when great expectations are put in a booming African agrifood sector and its contribution to “Africans feeding Africans”.

References

- Edquist C. 2011. Design of innovation policy through diagnostic analysis: identification of systemic problems (or failures). *Industrial and Corporate Change* 20 (6): 1725–1753.
- Floquet A *et al.* 2013a. Appropriation du soja et de ses dérivés dans l’alimentation humaine et animale, fruit de processus foisonnants et discontinus d’innovations. Cotonou: JOLISAA–Bénin: Université d’Abomey-Calavi.
- Floquet A, Mongbo R, Gbelidji Vodouhê G and Houèdokoho F. 2013b. No see, no hear, no talk – a three-monkeys fable in the ARD triangle: the agrofishing “hwedo” system of the Ouémé floodplain (Bénin). In: Triomphe B, *et al* (eds), *Innovation in smallholder farming in Africa: recent advances and recommendations* (Montpellier: CIRAD), pp91–95.
- Hall A, Janssen W, Pehu E & Rajalhati R. 2006. *Enhancing agricultural innovation: how to go beyond the strengthening of research systems*. Washington DC: World Bank.
- Hall A, Dijkman J & Sulaiman R. 2010. *Research Into Use: investigating the relationship between agricultural research and innovation*. United Nations University (UNU). Maastricht Economic and social Research and training centre on Innovation and Technology (MERIT).
- Michaud A. 2012. *Etude socio-économique des innovations survenues sur la filière soja au Bénin*. Mémoire de fin d’études. Cergy-Pontoise: Ecole Supérieure d’Agro-Développement International (ISTOM).

The JOLISAA project was funded under European Commission FP7 Grant Agreement 245319. The opinions expressed herein are the sole responsibility of JOLISAA. More information on JOLISAA can be found at www.jolisaa.net

Bringing new ideas into practice: learning from RIU experiments with agricultural innovation

Peter Gildemacher^{1*}, Remco Mur² and Mariana Wongtschowski¹

¹ *Royal Tropical Institute (KIT), Development Policy and Practice, Amsterdam, The Netherlands*

² *Research Into Use (RIU), University of Edinburgh, Edinburgh, Scotland*

* Corresponding author. Email: p.gildemacher@kit.nl

Abstract

To enhance food security and income African farming requires continuous innovation in response to changes in the agro-ecological and marketing environment. Research Into Use (RIU) explored different approaches to promoting innovation in agriculture. Five projects from RIU's Africa portfolio – the maize platform in Nyagatare, Rwanda; the cowpea platform in Kano State, Nigeria; the pork platform in Malawi; the Farm Input Promotions (FIPS) Best Bet in Kenya; and the armyworm Best Bet in Kenya and Tanzania – were analysed for their current and likely future impact. Based on these cases, three processes were distinguished in agricultural innovation: i) needs and opportunity identification, with entry points for innovation as result; ii) experimentation, with tested and tried promising new practices as result; and iii) bringing into routine use, with impact at scale as a result. The importance of public investments reduces while private-sector opportunities for investment increase from the first to the third process. Capacity to innovate can be characterised as the ability to effectively and continuously run these three processes. An intervention aiming at agricultural development would do well to invest in assuring impact at scale in the short run, while simultaneously investing in the capacity to innovate.

Keywords: *agricultural innovation, capacity to innovate, Research Into Use*

Introduction

African smallholder farmers continuously seek to improve their agricultural enterprises, to improve their food security and to increase their income by making more efficient use of their assets. Farmers have to adapt to continuous, often unforeseen and sudden, changes in their production and marketing environments, and this requires continuous innovation.

Research Into Use (RIU), a United Kingdom Department for International Development (DFID)-funded programme, explored different approaches to promoting innovation in agriculture (www.researchintouse.com) (Box 1).

Box 1: Research Into Use in Africa

The objective of RIU was to enable innovation in agriculture in Africa and Asia. The Africa country programmes in Malawi, Nigeria, Rwanda, Sierra Leone, Tanzania and Zambia aimed to improve the capacity to innovate, through strengthening collaboration between public, private, farmer and civil society organisations. The Best-Bet facility funded innovative business ideas to bring promising ideas into commercial use in Ghana, Kenya, Tanzania and Uganda.

Materials and methods

KIT studied a selection of projects from the RIU Africa portfolio: the Nyagatare maize platform in Rwanda; the cowpea platform in Kano State, Nigeria (Box 2); the pork platform in Malawi; the Farm Input Promotions (FIPS) Best Bet in Kenya (Box 3); and the armyworm Best Bet in Kenya and Tanzania. The expected impact pathway was constructed with the

“case holders” and key indicators were selected and measured through a mix of quantitative and qualitative methods. The main lessons learnt and value-for-money were assessed.

Box 2: RIU country programme Nigeria

As part of the RIU country programme in Nigeria, a cowpea innovation platform was established which brought together various actors from six states. The platform aimed to: i) increase production through the promotion of striga-resistant varieties; ii) reduce postharvest losses by weevils through popularising the use of triple bagging; iii) improve the efficiency of use of cowpea residues as fodder; and iv) support cowpea value-chain development through institutional changes. The cowpea platform contributed effectively to the popularisation and commercialisation of proven effective technologies. Whether the intervention sustainably improved capacity of the cowpea sector to innovate is debatable.

Box 3: FIPS–Africa Best Bet

RIU supported Farm Input Promotions–Africa (FIPS–Africa) to further develop its network of Village-Based Advisors (VBAs), who provide local agricultural extension services and market inputs as private entrepreneurs. FIPS supports the advisors with training and facilitates their access to new promising agricultural technology and inputs required for intensification of farm management. The impact assessment compared food security and farm-derived income between intervention and non-intervention households. The months of food self-sufficiency in FIPS villages increased from 7 to 12 and estimated revenues from production surplus increased fivefold. Considering this success, but at the same time the relatively low income generated by the VBAs and the prominent role of the donor-funded FIPS headquarters, continued investment of public resources in FIPS is required and justified.

Main results

Current and future impact

Looking at the five cases, one can be cautiously optimistic about the overall results obtained and the prospects for accumulating future impact (Table 1). In the case of cowpea in Nigeria and FIPS in Kenya, there is a clear current impact on household income and food security, while in the case of the maize platform in Rwanda and, to a lesser extent, the armyworm best bet, there is the promise of future impact based on the work already done. FIPS in Kenya and the Nyagatare maize platform improved the capacity to innovate and the cowpea platform improved this capacity to some extent, while the armyworm best bet and the pork platform did not have an effect on the capacity to innovate. The five cases studied form only a subset of the RIU programme in sub-Saharan Africa; these results cannot be considered representative of the entire programme.

The process of agricultural innovation

The linear transfer-of-technology model of thinking about change in agriculture has been replaced by innovation systems thinking (Spielman *et al* 2009, Hall *et al* 2006, Arnold & Bell 2001). Innovation is context-specific and usually involves a re-ordering of relationships and interactions between stakeholders (Leeuwis & Aarts 2011). Therefore, successes cannot simply be “copied”. What is lacking is a vision of how to use promising practices that have been proven in one environment in an effective manner to realise change on a larger scale.

Based on the five case studies, without resorting back to the linear transfer-of-technology model, three different processes in agricultural innovation can be distinguished (Figure 1):

1. Needs and opportunity identification
2. Experimentation
3. Bringing into routine use.

Table 1: Summary of results of the five cases

Case	Major results	Current HH impact	Future HH impact	Capacity to innovate
FIPS Best Bet	<ul style="list-style-type: none"> - Measurable income improvement - Food security improvement - Improved research-extension-farmer linkages - Alternative agricultural service provision system at scale - Better access of producers to improved technology 	+	+	+
Armyworm Best Bet	<ul style="list-style-type: none"> - Community-based forecasting adopted within ministries - Public extension/local government linkages improved - Change in perception of role of producers in agricultural services - Private biotech laboratory initiated 	-	+/-	-
Pig Platform Malawi	<ul style="list-style-type: none"> - Farmer-run pig slaughtering and marketing facilities built 	-	-	-
Maize Platform Rwanda	<ul style="list-style-type: none"> - Multistakeholder platform functional - Farmer-run maize trading company built - Inventory credit system piloted - Improved maize production popularised 	-	+/-	+
Cowpea Platform Nigeria	<ul style="list-style-type: none"> - National Agricultural Research Council adopted platform approach - Triple-bagging technology popularised and commercialised - Multipurpose, striga-resistant varieties popularised - Improved fodder-bailing technology developed and promoted 	+	+	+/-

Note: HH = household

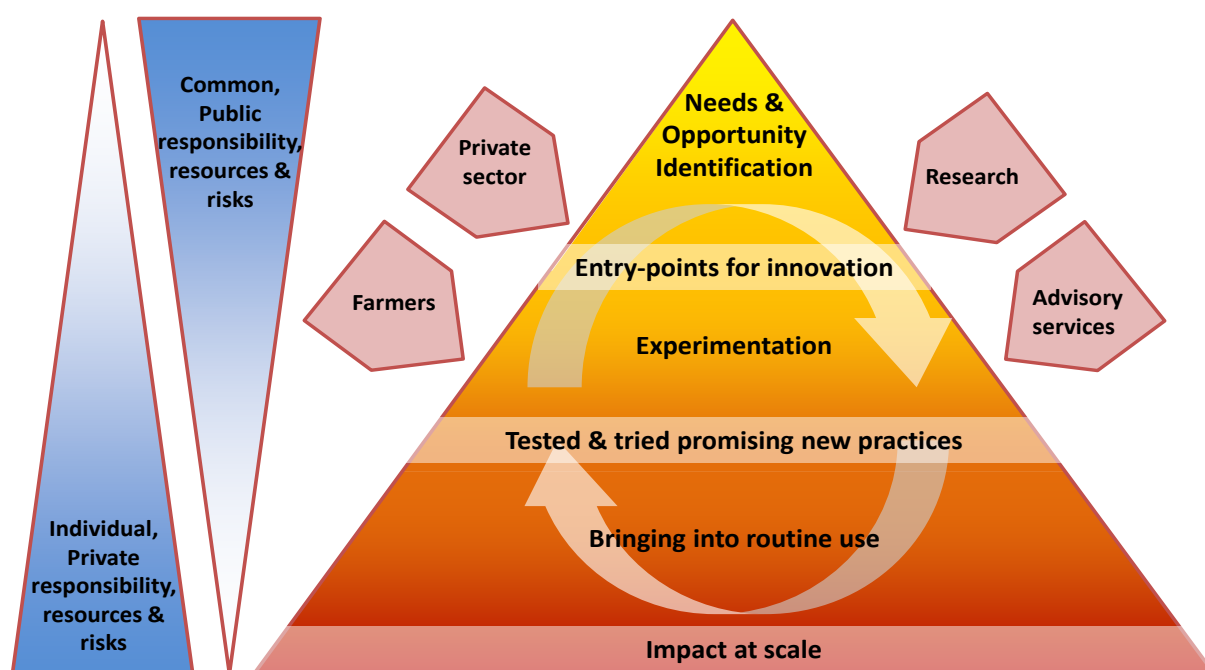

Figure 1: The deliberate process of agricultural innovation for impact at scale

Although depiction of innovation in a two-dimensional figure does carry the risk of oversimplification, it can be helpful for the process to distinguish between components of agricultural innovation. There is a general flow from identifying opportunities to bringing into routine use, but the three processes can take place simultaneously. There is a trend of shifting from pre-competitive collaboration for the common interest, using dominantly public resources, at the top of the figure, to a multitude of more competitive efforts during the process of bringing into routine use, with an increasing importance for private resources.

The basis of the process of agriculture innovation is the identification of needs and opportunities. The objective of a needs and opportunity assessment is to identify entry points for innovation. Needs and opportunities can originate from multiple sources, who may be farmers, private entrepreneurs, researchers or others, and they are meant to trigger the initiation of local experimentation with new practices.

Experimentation can focus on farming technologies, but also on new market relations, services or collaboration models. The objective is to arrive at tried and tested promising new practices. One characteristic that distinguishes experimentation from “bringing into routine use” is that the experimentation process is often “pre-competitive”, in the public interest, and provides information and experience to a wider audience. A second important characteristic is that experimentation includes room for failure and consequently carries higher risk.

“Bringing into routine use” aims at moving from promising new practices to impact at scale. This process also requires experimentation, risk-taking and local adaptation, much like the experimentation phase, but it differs in the levels of risks that need to be taken and the amount of room for failure. The process of “bringing into routine use” is characterised by competitiveness, which provides the pressure needed to assure efficient use of resources and quality of production and service delivery. There is less emphasis on developing public benefit; the focus is on assuring sustainable and lasting, cost-effective or profitable service delivery and production.

Key lessons and recommendations for policy and practice

Next to an immediate and measurable objective of realising impact at scale during the lifespan of a project, improving the capacity to innovate should be considered an objective of equal or even higher importance. Thus, an intervention programme would do well to invest in assuring impact at scale in the short run, while simultaneously investing in the capacity to innovate.

Seeking a direct linear relation between agricultural research results and agricultural development can easily lead to an unnecessary limitation of options being considered as entry points for innovation. Research is an important source of potential entry points, but not the only source. Therefore, a distinction needs to be made between funding research initiatives, which aim at enriching our knowledge through developing and testing theory, and promoting agricultural innovation. With respect to the process of agricultural innovation, it is important to acknowledge the three interrelated processes that underlie agricultural innovation: needs and opportunity identification, experimentation and bringing into routine use. Focusing on only one or two of these processes does not necessarily mean no impact can be achieved; however, this would assume that the other functions are well taken care of. Research organisations have an important role to play in agricultural innovation, but they are not the essential drivers of the process.

Conclusions

In agricultural innovation, three processes can be distinguished:

- 1) needs and opportunity identification, resulting in entry points for innovation
- 2) experimentation, resulting in tested and tried promising new practices

3) bringing into routine use, resulting in impact at scale.

The opportunities for investment by the private sector are largest during the process of bringing into routine use. Public (including donor-funded) efforts are more dominant during the needs and opportunity identification and experimentation. During needs and opportunity identification, it is essential to be open to multiple sources of ideas. The process of experimentation is pre-competitive with a high risk of failure, whereas the process of bringing into routine use is lower risk and more competitive, and resource-use efficiency is essential. Promoting agricultural innovation should be distinguished from supporting agricultural research, as agricultural research contributes to the process of agricultural innovation, but is not its single unique driver.

References

- Arnold E & Bell M. 2001. Some new ideas about research for development. In: DANIDA (ed.), *Partnership at the leading edge: a Danish vision for knowledge, research and development* (Copenhagen; Danish Ministry of Foreign Affairs), pp279–316.
- Hall A. 2006. Public-private sector partnerships in an agricultural system of innovation: concepts and challenges. *International Journal of Technology Management & Sustainable Development* 5: 3–20.
- Leeuwis C & Aarts N. 2011. Rethinking communication in innovation processes: creating space for change in complex systems. *Journal of Agricultural Education and Extension* 17: 21–36.
- Spielman DJ, Ekboir J & Davis K. 2009. The art and science of innovation systems inquiry: applications to sub-Saharan African agriculture. *Technology in Society* 31: 399–405.

Disclaimer

This document is an output from the Research Into Use Programme funded by the UK Department for International Development (DFID) for the benefit of developing countries. The views expressed are not necessarily those of DFID. A comprehensive overview and the full review can be downloaded at www.kitpublishers.nl or at www.researchintouse.com

Innovation research in high-value commodity chains: lessons learnt

Henning Høgh Jensen^{1,*} Charles Odhong², Richard N. Onwonga³ and Niels Halberg⁴

¹ *AgroTech A/S Institute for Agri Technology and Food Innovation, Aarhus, Denmark*

² *Department of Animal Production, University of Nairobi, Kenya*

³ *Department of Land Resource Management and Agricultural Technology, University of Nairobi, Kenya*

⁴ *International Centre for Research in Organic Food Systems, Tjele, Denmark*

* Corresponding author. Email: HHJ@agrotech.dk

Abstract

This paper reports on the main findings emerging from a research alternative to the two dominant paradigms in agricultural development. This alternative is both context-driven and problem-focused on the rapidly developing East African market-oriented agriculture that demonstrates high economic growth rates based on high-value market-driven commodity chains. The approach to this innovative research in high-value chains includes information feedback loops that bring back translated reports regarding market requirements, retailers' requests, tailor-made production techniques etc. These reports include price-determining information such as preferences for certain quality attributes, e.g. colour, size and texture, in addition to extrinsic quality attributes, e.g. food safety and production method, as well as the values that are embedded in certified organic, environmental issues or place of origin. The research was conducted in close collaboration with farmers to increase the adoption rate of the innovations being developed.

Keywords: *innovation, East Africa, agricultural development, high-value market chains*

Innovations are changing the production-market landscape

Two paradigms or narratives have dominated agricultural research for several decades (Figure 1). One is that sub-Saharan African smallholders operate far inside their production-possibility frontier and industrialisation is required. Another suggests that farmers produce close to or on the frontier of the capacity of the agro-ecology and focused on livelihood (Freibauer *et al* 2011, Barrett *et al* 2002).

Overtaking these two narratives is the rapid innovation and change in the production-market landscape, demonstrated by the many smallholders in East Africa who are undergoing a profound transition from cereal-based subsistence farming to mixed-enterprise market-oriented agriculture and the high economic growth rates based on high-value market-driven commodity development (Radelet 2010). We will call the latter the “innovation narrative”.

The lessons learnt reported here are partly based on the research project “ProGrOV” (Productivity and Growth in Organic Value Chains), a project that aims at strengthening the farmers' ability to supply the products that the markets require. The partners of ProGrOV, which is supported by the Danish Government, are three East African and two Danish universities, as well as AgroTech A/S, the International Centre for Research in Organic Food Systems and the national organic organisations in Uganda, Kenya and Tanzania (www.icrofs.org/Pages/Research/progrov.html).

The research concept

The basic characteristic of a value chain is that there is value addition at each step along the production chain (Figure 2) through the combination of additional resources like manpower, tools, knowledge and skills, and perhaps other raw materials. To enable this value addition, there has to be feedback information from the market or retailers to the processors and the

producers as per the systems thinking dynamics (Morecroft 2007). The feedback loops need to ensure that the emerging opportunities and challenges from a dynamic market will be appropriately embraced by the actors in the chain.

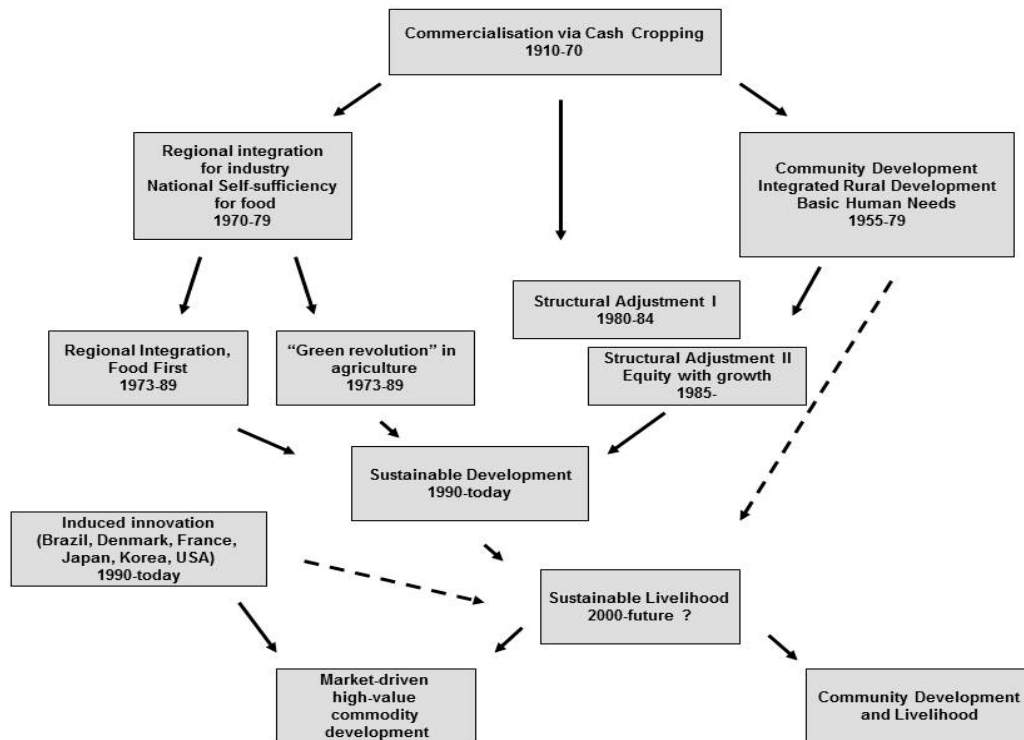

Figure 1: Chronology of paradigms in agricultural development. Two pathways dominate, one leading to a “green revolution” high-input approach and the other leading into community development (after Høgh-Jensen *et al* 2010).

This requires not only information flow but also skills to interpret the signals and react to them with skills and resources, e.g. in the form of new product innovations, which again often require innovations in the primary production. For smallholder farmers, this might pose a significant challenge without significant back-up or support from other chain actors. There are different options to ensure that the value addition is actually beneficial to the weaker agents in the chain, such as poorly organised smallholder farmers (Sanginga *et al* 2007). ProGroV focuses on smallholder organic cash crop farmers.

In this context, we understand innovation as being linked to entrepreneurs and representing *newness*. It is related to *invention* or to its process of *adoption*. As such, innovation is both a *process* and an *outcome*, where the most important final feature may involve change or a *discontinuity* with the prevailing product or market (Drucker 1985). Local innovation can be triggered by many factors as farmers explore new possibilities to solve a problem or a social way of responding and adapting to change in access to natural resources, assets or markets (Figure 2).

Our approach to research in innovation and high-value chains (Figure 3) for agricultural commodities depicts information feedback loops that bring back translated reports (signals) regarding market requirements, retailers’ requests etc. These signals may include price-determining information such as preferences for certain intrinsic quality attributes (e.g. maturity, size/weight, uniformity in colour, shelflife). It could also be extrinsic quality attributes such as food safety, and the values that are embedded in certified organic farming or place of origin.

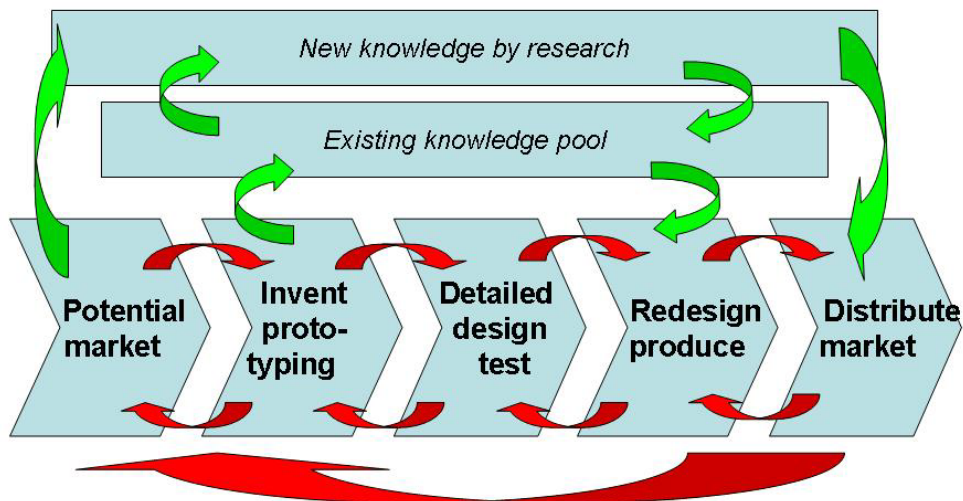

Figure 2: A general value-chain-linked model showing flow paths of information and cooperation (Kline & Rosenberg 1986)

In addition to this complexity, a product may have different markets that emphasise different attributes. For example, fruits are needed at different degrees of maturity by two apparently fairly similar markets in Europe. Conversely, it can be a product that is sold both at a local market, which has an emphasis on its role as a traditional dish, and in an export market, where it is valued because of its exotic flavour.

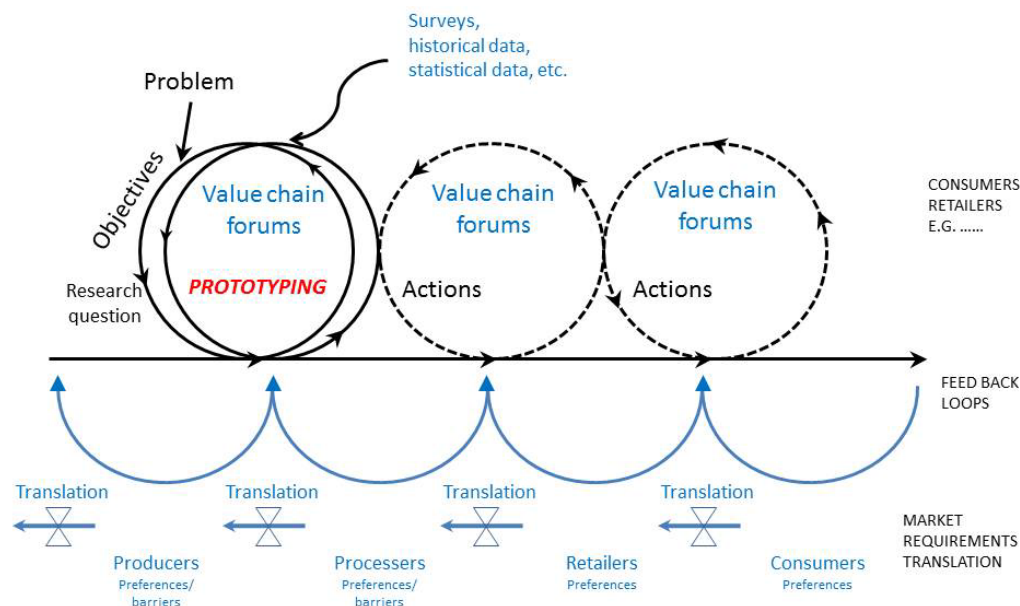

Figure 3: Schematic representation of innovation research in primary value chains involving relevant stakeholders (Høgh-Jensen 2013)

The approach to quality in ProGrOV research programme

During the early stages of ProGrOV, it became clear that market requirements such as quality attributes were complicated to describe in ways that make them “researchable” (quantify

and/or qualify, reproducible). For the purpose of the ProGrOV project, we have *a priori* chosen to focus on organic value chains with certain extrinsic quality attributes attached to them, such as vegetables for “upper-end” consumers. However, there are still important intrinsic quality attributes that organic products need to reach to gain market access at satisfactory prices (Figure 3). Thus, research needs to take these intrinsic quality attributes into account to improve organic production at farm level.

These intrinsic quality attributes should be translated into quantifiable quality criteria to be used for assessing the crop and livestock production resulting from the innovations tested in ProGrOV. An indication that, for example, *the colour of tomatoes* is an important attribute for the buyers thus would need to be translated into *a scale of per cent green parts of a batch of tomatoes*, which would then be applied systematically to assess the tomatoes harvested in crop experiments with, e.g., mulching materials.

The information on the attributes, their prioritisation and thresholds will come from interactions with the chain agents, e.g. buyers, retailers, hotels. Thus, product quality in the ProGrOV project is a relative and context-dependant concept and is neither objective nor covering all aspects of intrinsic product quality. This means that actors struggle to translate and backcast along the value chain the market intelligence into quantifiable indicators that operators of the practice would understand. Following the dynamics in value chains, the indicators must be questioned constantly to ensure that they still reflect the targeted market(s).

Stakeholders’ test of prototypes

The ProGrov research process is informed by the stakeholders, such as the national organic organisation, farmers, private companies, policy alliances and local supermarkets (Figure 3 – the upper side of the diagram). The research questions and findings are tested in value-chain stakeholder fora to which possible solutions are presented in the form of prototypes. These fora present an opportunity for reality checks for the researcher and enable the proposed solutions to be finetuned, i.e. they could be seen as innovation platforms. The fora obviously differ along the value chain (Figure 3). Thus, if one assumes that a certain input of livestock manure could improve the amount and quality of vegetables, then before testing this intervention experimentally, it is necessary to discuss the feasibility of the intervention with the farmers (e.g. would they be able to apply the tested amounts?). This process can be understood as prototyping. Farmers accepting or shunning the intervention during the forum consultations partly depends on their own request and initial framing of the problem, which were fed into the research process. Yet barriers are met underway in the project process. An intensification of a livestock–vegetable production system could, for example, be thought to diversify farmers’ earnings and make them less vulnerable to natural and economic shocks associated with the single-commodity approach in agriculture. This may, however, meet barriers such as how to handle and use manure efficiently from a resource-use point of view or allocation of land for fodder versus cash crops.

Value-chain research can thus be said to provide a tool or an interdisciplinary research approach to help researchers, entrepreneurs and other stakeholders at each node of the value chain to identify relevant research questions that can help optimise the whole chain. This requires consultations, interdisciplinary teams and regular mutual reminding of the particular characteristics of *value chains*, as many have a *supply-chain approach* as their intuitive reflection of the African agribusiness environment. This research approach is a further development of the general concepts described in the academic literature (Figure 3) and the first lessons learnt can be reported.

Approach and lessons learnt

Complexities are a norm for real value-chain problems and hence we propose an approach to research in innovation that is both context-driven and problem-focused. This approach

departs partly from the traditional university-based, investigator-initiated and discipline-based knowledge production, which focus on a linear dissemination process. Currently, it is an open question to us how research in innovation and entrepreneurship, i.e. market-driven high-value commodity development (Figure 1, 2 and 3), can comply with agricultural research paradigms (see also Nowotny *et al* 2001, Carayannis & Campbell 2012). Some lessons learnt are:

- When developing new value chains, there will be winners and losers, as it takes capacity to join the market orientation towards high-value commodities. This counts for producers, processors, transporters, buyers and retail sellers.
- To have a significant impact, the research must be accompanied by formalised networks of relevant actors, which may be termed “learning alliances” or innovation platforms as illustrated in the upper part of Figure 3.
- Value-chain-based research is a challenge in discipline-oriented university environments, as the problems investigated cut across discipline boundaries. But this can be developed.
- Agribusiness in Africa has a history of being based on supply chains. The perception of value addition must be kept in mind through constant reminders. Researchers tend to be absorbed by their research questions and may forget to crosscheck their intermediate findings with stakeholder fora, and the concept of prototyping has proven difficult.
- The paradigms that most agricultural research institutions follow are still dominantly the productivity narrative, which makes it difficult to legitimise research within a sufficiency or an innovation narrative.
- Academia has a long tradition of ways to give merit to research, but how to give merit to research in innovation and entrepreneurship is yet to be established.

References

- Barrett CB, Place F, Aboud A & Brown DR. 2002. The challenge of stimulating adoption of improved natural resource management practices in African agriculture. In: Barrett CB, Place F & Aboud AA (eds), *Natural resource management in African agriculture* (Wallingford: CABI), 1–21.
- Carayannis EG & Campbell DFJ. 2012. *Mode 3 knowledge production in quadruple helix innovation systems*. Springer Briefs in Business 7.
- Drucker P. 1985. *Innovation and entrepreneurship*. London: Heinemann.
- Freibauer A, Mathijs E, Brunori G, Damianova Z, Faroult E, Gomos J. G, O’Brian L & Treyer S. 2011. *Sustainable food consumption in a resource-constrained world: the 3rd SCAR Foresight Exercise*. Brussels: European Commission.
- Høgh-Jensen H. 2013. The bean – naturally bridging agriculture and human wellbeing. In: Muzzalupo I (ed.), *Food industry* (InTech–Open Access Publishers), pp23–33.
- Høgh-Jensen H, Oelofse M & Egelyng H. 2010. New challenges in underprivileged regions call for people-centred research for development. *Society and Natural Resources* 23: 908-915.
- Kline SJ & Rosenberg N. 1986. An overview of innovation. In: Landau R & Rosenberg N (eds), *The positive sum strategy* (Washington DC: National Academy Press), pp275–305.
- Morecroft J. 2007. *Strategic modelling and business dynamics*. Wiley.
- Nowotny H, Scott P & Gibbons M. 2001. *Rethinking science: knowledge in an age of uncertainty*. Cambridge: Polity Press.
- Radelet S. 2010. *Emerging Africa: how 17 countries are leading the way*. Washington DC: Center for Global Development.
- Sanginga P, Chitsike CA, Njuki J, Kaaria S & Kanzikwere R. 2007. Enhanced learning from multi-stakeholder partnerships: lessons from the Enabling Rural Innovation in Africa programme. *Natural Resources Forum* 31: 273–285.

Farms of the Future: an innovative approach for strengthening adaptive capacity

Andy Jarvis^{1*}, Julian Ramirez-Villegas¹, Valerie Nelson², Richard Lamboll², Nick Nathaniels^{2,3}, Maren Radeny⁴, Catherine Mungai⁴, Osana Bonilla-Findji¹, David Arango¹ and Caitlin Peterson¹

¹ CGIAR Research Program on Climate Change, Agriculture and Food Security (CCAFS), International Center for Tropical Agriculture (CIAT)

² Natural Resources Institute (NRI), University of Greenwich, UK

³ Independent consultant and NRI associate, UK

⁴ CGIAR Research Program on Climate Change, Agriculture and Food Security (CCAFS) East Africa

* Corresponding author. Email: a.jarvis@cgiar.org

Abstract

African farmers, rural communities and agricultural stakeholders urgently need to adapt to changing climates. In East Africa, agriculture is an important economic activity and contributes significantly to economic growth, yet is highly vulnerable to climate change. New knowledge, tools, institutions and approaches to learning are needed to build adaptive capacity. Farmers and agricultural stakeholders need to understand what their future climate is likely to be. The Farms of the Future (FotF) approach connects farmers to their possible future climates through farmer-to-farmer exchanges between analogue sites. The approach is based on identifying possible analogue sites for any given location using the CCAFS climate-analogue tool, study tours and participatory video to enable documentation of learning by farmers and sharing back to their community. The FotF approach can be used together with ongoing support for participatory action research to build reflective capacity and awareness of challenges and to identify and develop possible solutions among farmers and other stakeholders in the agricultural innovation system. This approach has been successfully piloted in Tanzania and Ghana in 2011–12. This paper presents the findings from Tanzania.

Keywords: future farming, climate-analogue tool, adaptation, participatory video, farmer study tours, Tanzania

Introduction

Global farming and food systems are increasingly facing unprecedented pressures from climate change, climate variability and environmental degradation. While many farming communities have long-standing knowledge and traditions of adaptation and risk management strategies, the trend and magnitude of change may surpass the limits of local knowledge, making their planning processes more difficult. This means that new knowledge, tools, institutions and approaches to learning are needed to build adaptive capacity. The inherent climate uncertainty and difficulty to understand what the future climate of a particular area will look like and how communities may respond is a major constraint to developing meaningful adaptation technologies and practices, policies and institutions.

In East Africa, the variable nature of rainfed agriculture and the smallholder subsistence production base increase the region's vulnerability to climate change and climate risks. While farmers in the region are already adapting to changing circumstances, including climate change, the changes tend to be marginal rather than transformational and appear to be limited to farming practices that are fairly easy to undertake without major disruptions to the farming system (Kristjanson *et al* 2012). Comprehensive agricultural adaptation strategies are, therefore, needed to meet the food and income needs of current and future generations.

In order to strengthen adaptive capacity and foster learning, farmers first need to understand what their future climate is likely to be. According to Williams *et al* (2007), 30% of the world climates are expected to be completely novel under climate change, which means that 70% of expected future climates already exist somewhere else on the globe. The spatial and temporal variability in climate can be used as a means of having a real experiment of what the future holds for a site. The CGIAR Research Program on Climate Change, Agriculture and Food Security (CCAFS) has developed a climate-analogue tool that connects sites with statistically similar climates (analogous) across space and/or time (Ramirez *et al* 2011) and helps to address the following questions:

- Where will I be able to find areas with a climate “possibly” similar in the future to the current climate of my site?
- Where can I find a place that currently has a climate that looks like the one expected for my site in the future?
- Where can I find similar areas to my site currently or in the future?

The Farms of the Future (FotF) approach uses the CCAFS climate-analogue tool to connect farmers to their possible future climates through farmer-to-farmer exchanges between spatial analogue sites. Spatial analogue refer to an area whose climate today appears to be similar to the future projected climate of another location.

Materials and methods

In East Africa, the first pilot of the FotF approach was carried out in Tanzania in 2012 by a team from the Natural Resources Institute (NRI), University of Greenwich, UK, in collaboration with CCAFS, Selian Agricultural Research Institute (SARI) and the African Highlands Initiative. In this pilot, some components were added to the overall FotF approach:

- *Initial participatory 3D modelling* of past, current and future change (climatic and social/environmental);
- *Participatory video* to facilitate farmers’ ability to document and share their learning experience with their own communities;
- *A study tour* instead of a farmer exchange involving a visit to a single spatial analogue site by the farmers as a way of taking into account the inherent uncertainties in climate modelling and to enable farmers to explore different dimensions of possible future climates, different social and environmental challenges, and known climate-adaptation projects or local adaptation practices of possible interest;
- *The learning processes* involving stakeholders from across the agricultural innovation system and farmers.

The CCAFS climate-analogue tool was used to identify possible spatial analogue sites for Lushoto, i.e. sites with a current climate similar to the projected future climate of Lushoto. Figure 1 shows the 15% best analogues for Lushoto to which 80% of the models agreed. The study-tour itinerary was also chosen based on locations with known adaptation projects or autonomous adaptation practices likely to be of interest to the participants and places experiencing similar social and environmental challenges, population pressure and land fragmentation. Prior to the study tour, a planning workshop was held in Lushoto to introduce the CCAFS climate-analogue tool to AIS stakeholders and facilitators (including the District Agricultural Livestock Development Officer and Agricultural Extension Officer, and representatives from various NGOs), to establish the willingness of communities and farmers to participate, to understand farmers’ perceptions of climate and other changes, and to train farmers in the use of video as a participatory learning tool.

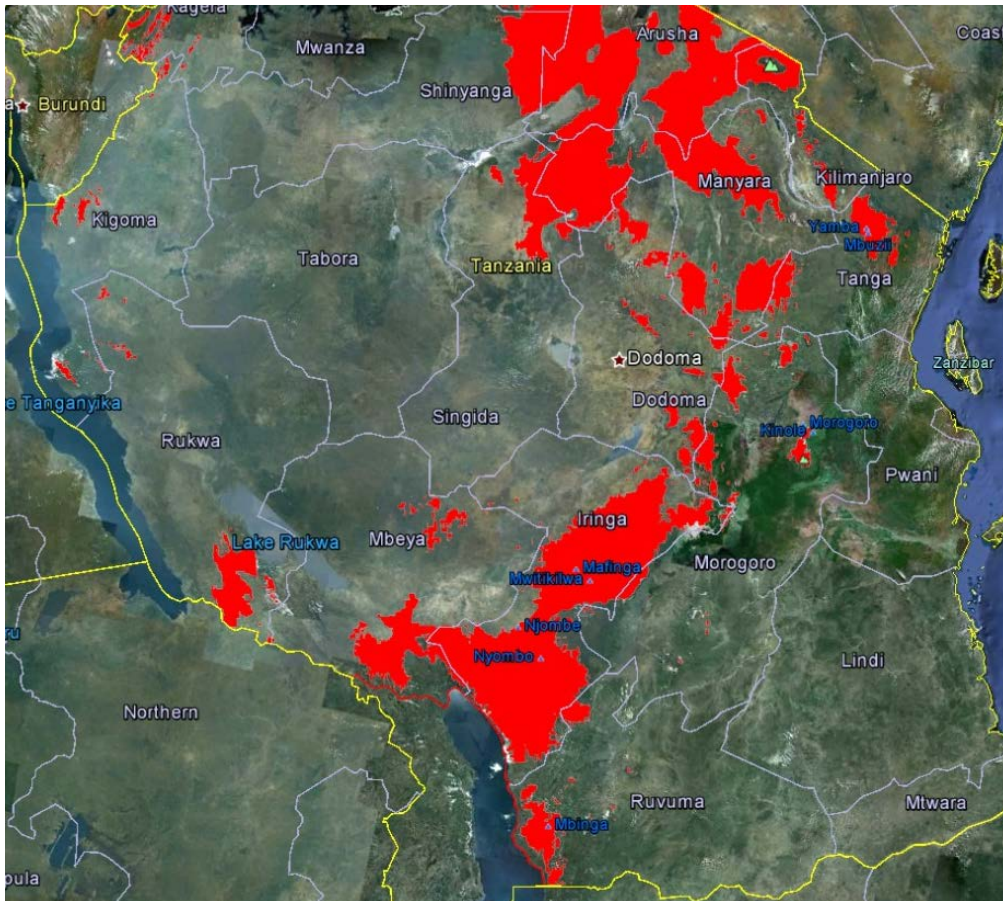

Figure 1: Lushoto analogue map with annual precipitation and temperature

The learning journey

Fifteen farmers and five key agricultural stakeholders from Lushoto in the Northern Highlands took part in a 10-day learning journey to several learning sites including Morogoro, Mufindi, Njombe and Mbinga in the Southern Highlands (Figure 2). The farmers were drawn from two villages (Yamba and Mbuzii) and comprised men and women. The AIS actors were drawn from different sectors including tourism, farm-input dealers, community development organisations, and agricultural and livestock officers.

The farmers and AIS stakeholders were exposed to a wide range of ongoing community-adaptation and risk-management strategies, both institutional and technological. The institutional strategies included collective action in savings and loans groups and Farmer Field School approaches. The technological strategies included Matengo pits in Mbinga District – a traditional soil and water conservation method used to prevent heavy rain from washing away the soil on steep slopes (Figure 3 and 4). The pits act as sediment traps that hold green grasses, thus simultaneously preventing the soil from eroding and providing a source of nutrients for the subsequent season. Other technological strategies included tree and coffee nurseries, fish rearing, beekeeping, and avocado, banana and maize trials.

The participatory video documentation, where the farmers used handheld flip cameras to document the learning process, enabled them to share their learning experience with other farmers in their own communities who did not participate in the study tour (Figure 5). A major outcome of the trip was the increased awareness of the participants of the changing climate and environment, and the need to act, as well as specific practical plans such as the formation of a Rotating Savings and Credit Association (ROSCA) by the farmers who participated in the study tour. With the necessary support, they anticipate to develop this into a fully-fledged Savings and Credit Cooperative (SACCO).



Figure 2: Map showing the study tour itinerary



Figure 3: Women farmers in Mbinga climate analogue site demonstrate how to construct Matengo pits



Figure 4: Matengo pits on a hillside in Mbinga, Southern Highlands



Figure 5: Matengo pits on a hillside in Mbanga, Southern Highlands



Figure 5: Farmers learning to use video cameras

Key challenges

Various challenges were encountered during the pilot of the FotF approach in Tanzania. First, climate modeling and projections have inherent uncertainties, especially in upland areas such as Lushoto, where major changes in altitude over short distances complicate the situation. Second, it became clear that preparatory communication with the different hosts in the learning sites is important to ensure clarity on the purpose of the visit. Third, social and cultural barriers such as gender inequalities often restrict women's mobility and participation in study tours and may hinder innovation and change from the learning process. Finally, on such a long journey, it is not always possible to stick precisely to the study-tour itinerary.

Key lessons and recommendations

The climate-analogue tool is most useful as a *learning* tool, rather than a predictive tool, and can be used to explore future scenarios and spark learning for adaptive action. However, understanding climate modeling can be challenging for people who are not climate scientists and more resources are needed to enable learning (e.g. at district level). Moreover, there are other obstacles to farmers' action including structural challenges, lack of access to seed funds, capital and information. The FotF approach is thus likely to be most effective when embedded within an overall participatory adaptation process, so that support can be given to the participants, their communities and wider agricultural system stakeholders to act on

insights and to innovate. Farmers need space to explore future horizons and potential challenges and opportunities, and can effectively learn from their peers. This learning is not necessarily about technology transfer, but also about institutional change and developing localised solutions. It is critically important to engage actors from across the agricultural sector, because of the uncertainties posed by climate change, the need for more flexibility in responses (e.g. from agricultural advisors) and the potential scale of the challenges ahead.

Conclusions

Significant opportunities exist for more farmer-to-farmer (and stakeholder-to-stakeholder) shared learning on adaptation. The study tours to spatial analogue learning sites can enable farmers and agricultural stakeholders to better envision how their site-specific agricultural future might look and can facilitate exchange of knowledge through which strategies and farming information can be shared. Strengthening adaptive capacity will also require institutional, structural and policy changes. To assess the outcomes of the pilot requires a follow-up visit to explore whether the study tour sparked new thinking and practical action and to assess its contribution to an overall participatory action research process, including identification of the social and cultural barriers to adaptation.

References

- Kristjanson P, Neufeldt H, Gassner A, Mango J, Kyazze FB, Desta S, Sayula G, Thiede B, Förch W, Thornton PK & Coe R. 2012. Are food insecure smallholder households making changes in their farming practices? Evidence from East Africa. *Food Security* 4: 381–397.
- Nelson V, Lamboll R & Nathaniels N. 2012. Farms of the Future Tanzania. Technical Report. NRI / CCAFS / CGIAR (<http://projects.nri.org/farmsofthefuture/project-outputs>).
- Nelson V, Lamboll R & Nathaniels N. 2012. Farms of the Future: Briefing 1: A promising approach for building adaptive capacity: lessons from Tanzania. NRI / CCAFS / CGIAR (<http://projects.nri.org/farmsofthefuture/project-outputs>).
- Ramírez-Villegas J, Lau C, Köhler AK, Signer J, Jarvis A, Arnell N, Osborne T & Hooker J. 2011. Climate analogues: finding tomorrow's agriculture today. Working Paper 12. Cali: CCAFS (www.ccafs.cgiar.org/resources/working-papers).
- Williams JW, Jackson ST & Kutzbach JE. 2007. Projected distributions of novel and disappearing climates by 2100 AD. *Proceedings of the National Academy of Sciences* 104 (14): 5738–5742.

To learn more:

- <http://ccaafs.cgiar.org/our-work/research-themes/progressive-adaptation/climate-analogues>
- <http://projects.nri.org/farmsofthefuture/>

Acknowledgements

Thanks to all the farmers and agriculture innovation system stakeholders from Lushoto who participated in the study tour, facilitators Juma Wickama (African Highlands Initiative), George Sayula (Selian Agricultural Research Institute and CCAFS Local Site Team Leader), Lebai Nsemwa (Agricultural Research Institute, Uyole) and to members of host communities, district extension staff and other specialists from Kinole Village, Morogoro District; Mwitikilwa Village, Mufindi District; Nyombo Village and Njombe Town, Njombe District; Sepukila Village, Masasi Village and Mtama Village, Mbinga District; and to Sokoine University of Agriculture, Morogoro.

Innovation in gadam sorghum production and marketing in Eastern Kenya

Justus M Kavoi^{1*}, Geoffrey M Kamau², Rachael K Kisilu¹, John W Wafula³ and Teresiah Ng'ang'a⁴

¹ Kenya Agricultural Research Institute (KARI), Katumani, Kenya

² KARI Headquarters, Nairobi, Kenya

³ Ministry of Agriculture, Katumani, Kenya

⁴ PROLINNOVA–Kenya

* Corresponding author. Email: jmkavoi@yahoo.com

Abstract

This paper relates to the assessment of innovation processes in a private-public partnership (PPP) to produce gadam sorghum for use by a Kenyan brewery. Individual and group semistructured interviews, observations and focus-group discussions were used in the study. The study found that use of production cells (organised groups of 15–20 farmers engaged in collective production and marketing of gadam sorghum), aggregation of the harvested sorghum and collective delivery led to supply of considerable volumes of sorghum. A technical innovation introduced by the farmers was the use of oxen-plough furrows for planting instead of the shallow handmade furrows recommended by the researchers. Some farmers interplanted sorghum with leguminous crops to suppress weeds and also planted small-grain crops around the sorghum fields or between sorghum rows to divert birds and reduce damage from them. Some farmers avoided bird damage by growing sorghum during the seasons of low bird incidence. Women used the gadam grain to prepare various recipes and thus supplemented maize for food. Eventually, a breakdown in communication between farmers and the marketing agent, labour shortage, use of sorghum for food together with supply of poor-quality seed contributed to reduction in sorghum supply to the brewery. A major lesson learnt was that PPP arrangements can be beneficial in smallholder farming but clear and constant multidirectional communication is essential between stakeholders. The study points to the need for monitoring frameworks to ensure efficient functioning in PPP arrangements and to enhance innovation in smallholder farming.

Keywords: *collective production, collective marketing, gadam sorghum, innovation processes, production cells, public-private partnership*

Introduction

The gadam sorghum case is about how small-scale farmers in the Lower Eastern Region of Kenya were involved in a public-private partnership (PPP) for producing and selling gadam sorghum grain to supply East African Breweries Limited (EABL). This came from EABL's need to secure the supply of a suitable alternative grain to replace barley in the brewing of beer. Researchers found gadam sorghum to be most suited on account of its high quantity of fermentable starch. The challenge was how to produce this sorghum in the traditional sorghum-growing areas in the arid and semi-arid lands (ASALs), where farmers now prefer maize despite its poor performance (Bett *et al* 2009, Kavoi *et al* 2010, Kavoi *et al* 2011). Several public- and private-sector stakeholders came together in a PPP initiative to support farmers in the production and marketing of high-quality gadam sorghum grain acceptable for the brewery. The stakeholders were EABL, the Ministry of Agriculture (MoA), Equity Bank, KARI (Kenya Agricultural Research Institute), Smart Logistics, farmers, the local administration, local politicians, seed companies and local NGOs. This paper focuses on the technical, social and organisational innovations that arose out of the PPP interaction.

In the framework of the EU-funded project JOLISAA (JOint Learning in Innovation Systems in African Agriculture), a collaborative case assessment (CCA) was made of the gadam sorghum PPP initiative. The main objective was to assess and understand the past and current

gadam innovation process(es). The specific objectives were to: i) establish the innovation background; ii) determine the status of sorghum commercialisation through the PPP initiative; iii) highlight any new directions and developments in the initiative including emerging issues, constraints and successes; and iv) identify lessons and recommendations for research, policy and practice.

Methods

Semi-structured interviews and focus-group discussions (FGDs) were conducted to collect data from key informants, individual farmers and groups. The issues covered included reasons behind the establishment of the innovation, stakeholders and their roles, activities at all stages, spread of the gadam sorghum innovation and the current status of knowledge and skills among the stakeholders. Key informants included staff from the MoA, Smart Logistics, Equity Bank and EABL and local traders. Interviewees among individual farmers and key informants were randomly selected from stakeholder group members who did not attend the meetings. Individual interviews included farmers who were not group members but were growing gadam and selling it through the farmer groups. The farmer groups included the original group involved in the innovation process as well as groups that learned from it. Seven general group discussions and three FGDs were held and also 15 individual farmers, three key informants and five key stakeholders were interviewed.

Main results

Various technical, social and organisational innovations were developed in production, marketing and use of sorghum. A combination of farmer sensitisation, formation of “farmer production cells” of 15–20 farmers, provision of certified seed and training coupled with practical sessions in the fields proved to be a more effective approach than individual farmer training. Farmers used the skills and practices learnt during the training to grow gadam sorghum and also combined it with their own practices such as planting seeds in plough-made furrows, planting leguminous crops to suppress weeds, interplanting small-grained cereal crops to divert birds and growing sorghum during seasons of low bird incidence.

Gadam sorghum grain aggregation and collection of the grain from a central site solved the challenge of scattered location of the farmers in the production area. This facilitated efficient and effective sorghum grain collection from the production region and delivery to the end-user of the grain, i.e. the brewery. Use of warehouse receipts for the delivered and graded sorghum followed by payment upon presentation to the bank was a novelty in the area. It was intended to ensure security for both the middle agent and the farmers, because it did not involve liquid cash transaction in the payment process. In addition, women farmers came up with various sorghum recipes and avoided over-reliance on maize for food, since maize performs poorly compared to sorghum on account of the low rainfall received in the region.

Challenges

The PPP model provided for a specific middle agent to aggregate and deliver gadam sorghum grain to EABL but did not take account of market prices offered by middlemen (brokers). Due to poor communication between the farmers and the middle agent, farmers sold their sorghum to other agents who offered better prices and also paid up front. Another challenge was that the model considered only seed but not other inputs such as fertilisers, pesticides and labour costs. The opening up of other production areas for gadam sorghum, e.g. Upper Eastern and Rift Valley, also led to less attention to Lower Eastern as a significant production zone. Moreover, study findings revealed that 60% of the harvested grain was retained for family food; this reduced the amount of grain delivered to collection centres. Moreover, provision of poor-quality seed by some companies and NGOs contributed significantly to poor harvest as well as to low levels of grain delivery to collection centres.

Key lessons learnt

Lessons learnt included a need for: i) clear and constant communication between stakeholders in PPP arrangements; ii) holistic attention to the full gadam sorghum value chain; and iii) studies of stakeholder dynamics. Policy interventions are needed in: i) moderating market prices; ii) formalising the use of warehouse receipting; and iii) clear definition of the role(s), responsibilities and commitments of all concerned stakeholders engaged in PPP initiatives to own up their responsibilities.

The gadam commercialisation model involved several partners who collectively provided resources for farmer mobilisation and capacity building. During the interviews, it was revealed that other groups not reached directly by KARI, MoA and the individual farmers currently growing gadam were introduced to the innovation by the initial groups and group members. The possibility of solving the food-insecurity problem in the ASALs and the huge demand for gadam sorghum for brewing (Karanja *et al* 2011) acted as triggers and drivers in the innovation process. The innovation of gadam sorghum attracted stakeholders from both the public and private sectors, and it is likely that the farmers will continue growing it, even if not for selling to EABL.

Conclusions and recommendations

Despite the challenges that were encountered in this initiative, it became apparent that the PPP model has potential to solve a major constraint in the form of fragmented production by individual farmers in rural areas. In a country where 80% of the agricultural production is by smallholders, this is an important finding. Through collective production, facilitated transportation and an assured market, it is possible to override many of the challenges faced by these low-income producers.

The study revealed that there is need for clear and constant communication between stakeholders in PPP initiatives to avoid misunderstandings. There is also need for attention to the full production chain, including both input and output markets. It is also recommended that PPP arrangements be deployed in various smallholder enterprises to boost agricultural production in Kenya. Additionally, it is recommended that frameworks to collect research feedback from the farmers should be put in place to capture the local innovations that the farmers introduce into initiatives such as the gadam sorghum one.

References

- Bett C, Ouma J & De Groote H. 2010. Perspectives of gatekeepers in the Kenyan food industry towards genetically modified foods. *Food Policy* 35: 332–340.
- Karanja D, Kavoi J & Mutuku R. 2011. Improving food security and incomes for farmers in semi-arid areas through commercialization of sorghum gadam production and marketing model with small-scale farmers. Paper presented during the End-of-Project Conference, 9–11 August, KARI Headquarters, Nairobi, Kenya.
- Kavoi J, Karanja D & Wafula J. 2010. Turning challenges into opportunities: commercialization of gadam sorghum in maize-dominated farming systems of lower semi-arid Eastern Kenya. Paper presented during the 12th KARI Biennial Scientific Conference, 8–12 November, KARI Headquarters, Nairobi, Kenya.
- Kavoi J, Karanja D, Wafula J, Kisilu R & Arithi C. 2011. Gadam sorghum commercialization through a public-private-partnership initiative in semi-arid Eastern Kenya: lessons learnt. Paper presented during the End-of-Project Conference, 9–11 August, KARI Headquarters, Nairobi, Kenya.

The JOLISAA project was funded under European Commission FP7 Grant Agreement 245319. The opinions expressed herein are the sole responsibility of JOLISAA. More information on JOLISAA can be found at www.jolisaa.net

Experiences from JOLISAA: three cases of multistakeholder innovation processes in South Africa

Brigid Letty^{1*}, Joe Stevens², Gerrit Rootman³, Ntando Buthelezi², Wojciech Jagiello⁴ and Bernard Triomphe⁵

¹ *Institute of Natural Resources, Scottsville, South Africa*

² *University of Pretoria, Pretoria, South Africa*

³ *Limpopo Department of Agriculture, Towoomba Research Station, Bela Bela, South Africa*

⁴ *University College Cork, National University of Ireland, Cork, Ireland*

⁵ *Cirad, UMR Innovation, Montpellier, France*

* Corresponding author. Email: bletty@inr.org.za

Abstract

Through the JOLISAA (JOint Learning in Innovation Systems in African Agriculture) project, smallholder-oriented, multistakeholder innovation systems were explored in South Africa. After an inventory of cases was compiled, three cases were identified for deeper exploration and cross analysis. Local teams of resource persons familiar with the cases were set up for each case. The first case involved bulk buying, where several stakeholders developed a system that allowed farmers to collectively purchase farm inputs, making use of funds derived from savings and credit groups. The second case involved the Agricultural Research Council and University of the Free State working with farmers to develop and test infield rainwater-harvesting technologies. The last was an outcome of the BASED (Broadening Agricultural Services and Extension Delivery) programme, which introduced a new extension approach that gave rise to experimentation related to soil fertility management practices. In all three cases, smallholder farmers were supported by outside organisations through projects/ programmes. These initiatives also considered the importance of institutional strengthening. The biggest challenge encountered was the extent to which innovation processes did not continue beyond the timeframe of the project – or were not documented beyond this point. The analysis led to some key lessons for supporting innovation processes, especially the recognition that non-technical innovations can sometimes address production challenges and that farmer mobilisation is often a key element of effective rural development. The cases also reflected that multistakeholder innovation processes that recognise local knowledge and encourage active farmer participation have intangible benefits related to building smallholders' confidence and capacities, which foster agricultural development.

Keywords: *innovation systems, multistakeholder partnerships, smallholder farming*

Introduction

The EU-funded project JOLISAA (JOint Learning in Innovation Systems in African Agriculture) explored the nature of smallholder-oriented, multistakeholder innovation systems across three countries, South Africa, Benin and Kenya. Combinations of multiple sources of knowledge are said to be necessary for effective agricultural innovation to develop solutions specific to certain contexts (Hall 2007). The range of stakeholders involved in such processes can include conventional information providers such as research organisations as well as less conventional sources such as neighbours and civil society organisations, the roles of which are often overlooked by outsiders (Spielman 2005).

In this paper, we synthesise key findings from three case studies developed in South Africa within the framework of the JOLISAA project. These focused either on technical innovation

(infield rainwater harvesting, soil fertility) and organisational innovation (collective savings and credit) or on new approaches to innovation. We also discuss some of the challenges met, and specifically the difficulty for innovation processes to continue beyond the timeframe of the project within which they were initiated. Finally, we present a few generic lessons.

Methods

The three cases were selected among 11 cases included in an inventory of innovation experiences identified in South Africa which met the JOLISAA criteria: at least three different stakeholder groups involved, smallholders having been an active partner and the innovation process goes beyond the initial stages (Triomphe *et al* 2013). The three cases were examined through collaborative case assessment (CCA) and were then subjected to a cross analysis. The CCAs were undertaken by local teams involving members of the national team, national or international students, as well as selected representatives of stakeholders (such as NGOs, extension services, research) who had taken part in the innovation process. The teams conducted semi-structured interviews and focus-group discussions with all stakeholders to better understand what gave rise to the innovation processes and how they unfolded, what stakeholders had been involved and with which roles, and what had been the contribution of smallholders to the innovation process.

Main results

The three cases are summarised in terms of the innovations themselves, the main stakeholders involved in the innovation process and the extent to which the innovation process was embedded within a project or programme rather than being a spontaneous process that was initiated by farmers without external support. The CCA also sought to clarify the extent to which smallholder farmers were able to contribute their ideas and creativity to the process.

The first case explored was infield rainwater harvesting, part of a project funded by the South African Water Research Commission in Thaba Nchu, a former homeland in the Free State Province. Researchers from the Agricultural Research Council (ARC) and University of the Free State worked with smallholder farmers to test infield rainwater-harvesting techniques in their homestead gardens. The techniques were originally developed on-station and then introduced to these rural communities. The farmers adapted some of the techniques introduced by the researchers, e.g. incorporating mulching with grass and stones to reduce the level of evaporation from the basins. They also proposed the use of the techniques for vegetable production and not just agronomic crops, which led to adaptation of the original concept. Apart from the technical component of the innovation process, the process of institutionalising the techniques called for new arrangements to organise farmers, which facilitated better planning of production practices, together with institutional innovation in the form of new research approaches being institutionalised into the ARC.

The second case was the experimentation with soil fertility management in Limpopo Province. It emerged from a GTZ-funded initiative of the Limpopo Department of Agriculture called the GTZ/BASED Programme (Broadening Agricultural Services and Extension Delivery), which developed and introduced a new extension approach called the Participatory Extension Approach (PEA). BASED led to on-farm experimentation to address various constraints articulated by smallholder farmers. One case of experimentation involved using different legumes as green manure to improve soil fertility and crop yields in smallholder cropping systems. This was in response to declining yields, which the farmers believed to be due to excessive rainfall in one year. After the initial experimentation, which was largely facilitated by the University of Venda, farmers continued with some of their own experimentation. This included experimentation with different organic fertilisers and out-of-season production of green maize cobs. Experimentation with the latter emerged after farmers

observed that the soil had higher water-holding capacity from green manuring and could thus support production outside of the normal production season.

The third case was the bulk-buying case, which was encountered in KwaZulu-Natal (KZN) Province where an NGO, SaveAct, and the Farmer Support Group (FSG), which is the outreach arm of the University of KZN, worked collectively with smallholder farmers to develop a bulk-buying system. The two organisations brought together complementary skills sets, namely financial and agricultural skills. The farmers were mobilised into groups through their participation in both the savings and credit groups (SCGs) as well as farmer learning groups (FLGs). In addition, FSG also supported the establishment of the Sivusimpilo Farmers' Forum, where farmers articulated the need for more affordable inputs and discussed with other stakeholders the possibility of buying in bulk. The system that emerged allowed farmers to collectively buy inputs (initially fertiliser but later herbicides and seeds) making use of annual share-outs from their SCGs. It is worth noting that the SaveAct/FSG partnership was established through the FAIR (Farmer Access to Innovation Resources) project under the umbrella of PROLINNOVA–South Africa¹², which encouraged innovative behaviour and supported both the farmers' forum and the FLGs.

The cross-analysis of the three cases revealed a number of interesting findings. Firstly, the cases demonstrated the range of stakeholders engaging in innovation processes – from formal researchers to NGOs as well as the smallholder farmers themselves – not just as beneficiaries but also as contributors of ideas towards solving their challenges. Secondly, in all three cases – as it was a criterion in the process of selecting the cases – smallholder farmers were the target audience, but what emerged without intention was that all cases involved smallholders were supported by outside organisations through different projects or programmes. Thirdly, these different initiatives all saw the importance of institutional strengthening as a basis for achieving rural development. As a result of this, they all invested resources in mobilising farmers and establishing structures that encouraged sharing of ideas, articulation of challenges and identification of possible solutions.

Key challenges met

In two of the cases, it emerged that the innovation processes either did not continue beyond the timeframe of the project or were not well documented beyond this point. In the third case (bulk buying), the process was still too young to know whether or not it would be able to sustain itself in the long term, once the external NGO that had facilitated it took a back seat.

Documentation is largely restricted to project timeframes and does not always give recognition to activities that were not planned. For example, in the soil fertility case, it was mainly through the CCA process that stakeholders became aware of the farmer experimentation that had continued beyond the timeframe of the BASED programme.

Another challenge encountered in the same case was that some farmers mentioned not being able to source the seed with which they had experimented, which prevented them from continuing to apply the new production practices. These types of situations that threaten continuity need to be anticipated when projects are planned.

Key lessons and recommendations

From the analysis of these three cases, some lessons emerged that inform recommendations for practitioners engaged in rural development, be they extension officers, researchers or NGO staff.

¹² PROLINNOVA: PROMOTING Local INNOVATION in ecologically oriented agriculture and natural resource management (www.prolinnova.net)

Firstly, non-technical innovations (such as the development of a bulk-buying system that enables access to affordable inputs) are equally important in addressing production challenges. Similarly the mobilisation of farmers is often an essential component of any rural development initiative. Many of the innovation processes encountered comprise “innovation bundles”: not just one type of innovation is operating in isolation but rather is accompanied by other complementary but different innovations. Often, these bundles comprise combinations of technical, institutional and organisational innovations. Another point worth noting is that the separate elements of the innovation process do not always happen absolutely concurrently. Sometimes, a new technology is introduced, which then leads to a second innovation in response to another need that emerges. Lastly, it appears that the multistakeholder innovation processes built capacity among smallholders and triggered subsequent innovation. Thus, the analysis of the cases shows that multistakeholder innovation processes that recognise local knowledge and that encourage the active participation of farmers have intangible benefits related to building confidence among smallholders, which fosters agricultural development.

Conclusions

Multistakeholder innovation processes lead to the development of technological, institutional and/or organisational innovations that address challenges farmers face as well as allowing them to seize opportunities they encounter. Organisations supporting smallholder farmers should foster creative, problem-solving behaviour and provide access to other organisations that can add value to the innovation process, thus providing a brokering role.

References

- Hall A. 2007. Challenges to strengthening agricultural innovation systems: where do we go from here? UNU-MERIT Working Paper Series #2007-038. Maastricht: UNU-MERIT
- Spielman DJ. 2005. Innovation systems perspectives on developing-country agriculture: a critical review. ISNAR Discussion Paper 2. Washington DC: International Food Policy Research Institute.
- Triomphe B, Floquet A, Kamau G, Letty B, Vodouhê SD, Ng'ang'a T, Stevens JB, Berg J van den, Sellamna N, Bridier B, Crane T, Almekinders C, Waters-Bayer A & Hocdé H. 2013. What does an inventory of recent innovation experiences tell us about agricultural Innovation in Africa? *Journal of Agricultural Education and Extension* 19 (3): 311–324.

The JOLISAA project was funded under European Commission FP7 Grant Agreement 245319. The opinions expressed herein are the sole responsibility of JOLISAA. More information on JOLISAA can be found at www.jolisaa.net

Agricultural innovation funds at community level in Kenya

Chris Macoloo¹, Geoffrey Kamau^{2*}, Makonge Righa¹, Teresiah Ng'ang'a³, Ann Waters-Bayer⁴ and Laurens van Veldhuizen⁴

¹*World Neighbors (WN), Nairobi, Kenya;*

²*Kenya Agricultural Research Institute (KARI), Nairobi, Kenya*

³*PROLINNOVA–Kenya, Nairobi, Kenya*

⁴*ETC Foundation, Leusden, Netherlands*

* Corresponding author. Email: gmkamau_1@yahoo.com

Abstract

This paper deals with the implementation and outcomes of a pilot study on farmer-managed Local Innovation Support Funds (LISFs) in Kenya, designed to explore whether decentralised funds for agricultural research and development (ARD) could be mechanisms for promoting local innovation. At four sites in Eastern and Western Province, men and women farmers proposed, conducted and evaluated their own experiments funded through the LISFs. They identified other ARD actors to support their efforts to improve farming and shared their findings with other farmers and formal scientists. Smallholders proved to be willing to and capable of managing public funds for decentralised and locally relevant innovation development. They showed how their knowledge and creativity contribute to ARD. They gained more confidence to interact with other ARD actors. While facilitating this work, scientists and development practitioners became more aware of smallholders' capacities to innovate and more interested to engage in farmer-led experimentation. The LISF process encountered various challenges, including the negative mindset of many scientists about local innovation, limited capacities for decentralised fund management and difficulties in generating in-country funds to replace external donor funds. The initially high overhead costs were for the training, advisory support and monitoring that allowed joint learning about LISFs during the piloting. Greater capacity is needed in facilitating interaction between farmers and other actors so that the farmers remain in control. The supporting organisations, including relevant government departments, need to mainstream LISF facilitation in their core activities and influence policymakers to recognise smallholders' contribution to ARD.

Keywords: *research funding, smallholders, local innovation, farmer experimentation*

Introduction

Since time immemorial, smallholders have been experimenting and innovating to improve their farming, with little or no recognition or support from governments or other agencies. However, in conventional agricultural research and development (ARD), funds are normally granted only to formal scientists to generate new ideas and data for extension. Agricultural innovation has been viewed as their preserve (Kamau & Almekinders 2009). In recent years, other approaches to ARD emerged. One example is the approach of recognising local initiatives and stimulating farmer-led participatory innovation development (PID). A network that champions this is PROLINNOVA (PROMoting Local INNOVation in ecologically oriented agriculture and natural resource management, www.prolinnova.net), a Global Partnership Programme under the Global Forum on Agricultural Research (GFAR). PROLINNOVA's vision is "a world in which women and men farmers play decisive roles in agricultural research and development for sustainable livelihoods". It seeks to link farmer innovation with formal ARD so as to enhance local learning and community-driven development.

Recognising that smallholders are not merely recipients of new knowledge generated elsewhere but are actively involved in its generation, PROLINNOVA wondered whether smallholders' role in ARD could be enhanced if funds for local innovation were made available directly to and managed by them. Are such funding mechanisms feasible and could they be cost-effective and sustainable? Would they stimulate and accelerate local innovation processes? Would this approach generate interest among scientists to support farmer-led PID? Could this approach complement conventional ARD? PROLINNOVA started action research in eight countries (six in Africa and two in Asia) to explore these questions, with support from the French and Netherlands Governments and the Rockefeller Foundation. The basic principles underpinning the Local Innovation Support Funds (LISFs) are that farmers directly access the resources, play a central role in fund management and determine what aspects of experimentation and innovation are funded (see also www.prolinnova.net/lisf).

How LISFs were piloted in Kenya

The piloting of LISFs started in Kenya in 2008 at four sites: Machakos and Mwingi Districts in Eastern Region and Busia and Nyando Districts in Western Region. In the inception workshop, diverse stakeholders discussed the principles of local innovation and experiences with locally managed funds in Kenya and elsewhere. They made a workplan to guide the LISF piloting and formed a National Steering Committee (NSC) of eight partner organisations to provide oversight to this initiative: World Neighbors (WN), Kenya National Dissemination of Agricultural Technologies (KENDAT), Institut Africain pour le Développement Économique et Sociale (INADES), Kenya Agricultural Research Institute (KARI), Resources Oriented Development Initiatives (RODI), Sustainable Agriculture Community Development Programme (SACDEP), Participatory Ecological Land Use Management (PELUM) and Sustainable Agriculture Centre for Research and Development in Agriculture (SACRED). Four partners were given specific responsibilities: WN to handle overall coordination and facilitate piloting in Western Region, where it was already working; KENDAT and INADES to facilitate piloting in Eastern Region because of their presence there; and KARI to coordinate all monitoring and evaluation because of its national presence. Local Steering Committees (LSCs) comprising representatives from local farmer groups, local NGOs, community-based organisations and government departments were formed at each pilot site. They were responsible for soliciting proposals, screening and forwarding them to the NSC for final approval, recording data in the register, releasing funds and local-level monitoring (Figure 1). By forming the LSCs, the LISF was decentralised to an extent that smallholders could access the funds without much bureaucracy and could be involved in identifying local innovations and managing the funds.

Key operational documents were developed to assist in piloting LISFs in Kenya. These were:

- Flyers describing the LISF, which were placed strategically in offices of faith-based and other development organisations, provincial administrations and government departments; announcements were also made at public meetings, in marketplaces and during social events such as weddings and funerals;
- A guideline for proposals (title, short description of innovation/experiment, objectives, budget);
- A grant agreement to be signed between the successful applicants and the LSCs, stating the nature of the agreement and the approved amount;
- An assessment form with the key criteria for proposal evaluation such as originality; economic, social and environmental soundness; applicability by resource-poor farmers; willingness to share results with others; and potential for further improvement.

Individuals or groups could collect application forms from the LSC in their area, fill them in and return them to the LSC. The LSC assessed and forwarded all applications with its

recommendations to the NSC for final approval. After the successful applicants signed the contract, funds were sent either directly to their accounts or to those of LSCs for onward remittance if the farmer/group had no bank account. Then the farmers began their activities with support from the LSC and the NSC. The recipients were asked to make reports, noting any follow-up and further support needed.

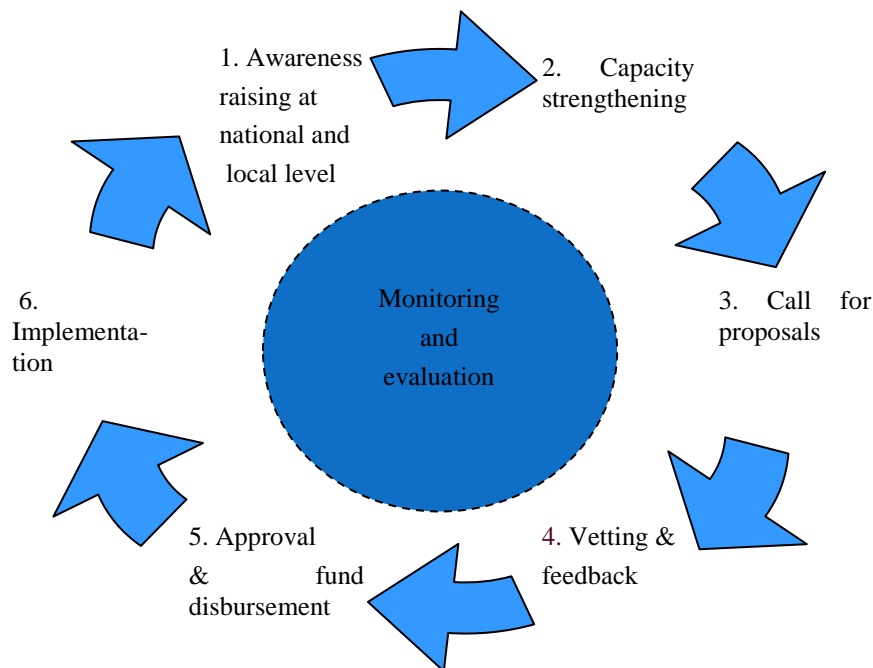

Figure 1: The LISF cycle

Main results and achievements

Over two rounds of proposals, a total of 125 applications were made. Initial rejection rates were high because the applicants needed time to understand the purpose of the innovation fund to produce public goods (research results and innovations) at community level rather than to advance their private farm enterprises. Grants ranged from €85 to €500 per proposal and were used primarily for improving farmers' innovations; 49% of the applicants were women; and the processing time from receipt of applications to disbursement of funds was 89 days. The range of innovations explored with LISFs included planting millet in nurseries to transplant in fields, homemade supplementary feed for goats, modified beehives to increase honey production and modified *zai* pits to retain moisture for crops. These activities were led by individual members of farmer groups, who shared the findings within their groups and with other community members.

Although this was a pilot, participatory impact assessment already brought notable achievements to light (PROLINNOVA 2012a, 2012b; Rockefeller Foundation 2012):

- Enhanced social organisation around managing local funds through the formation of LSCs and organising farmer-to-farmer visits and fairs for sharing and joint learning. The LSCs' capacities were strengthened as they did local monitoring of activities and compiled reports to the NSC.
- Recognition of women as innovators and fund managers. In Kenya, women constitute the greater proportion of smallholders – and of innovators – and their participation as LSC members in managing local funds helped bring their agenda to the fore.

- Greater confidence of smallholders to interact with outsiders, e.g. they entered into PID with scientists in KARI and Nairobi University on the millet nursery and goat feed innovations.
- Recognition of smallholders' capacity to engage in significant agricultural innovation stimulated the interest of some scientists, especially in KARI, to support farmer-led PID. Two farmer grantees were cited by the Kenya National Council of Science and Technology after their LISF-supported innovations were among the top 14 out of 40 agricultural innovations at a national exhibition in Nairobi in 2011.

The spread of farmers' innovations showed that these address fundamental challenges facing farmers. For example, many households in Eastern Kenya are now planting millet in nurseries before transplanting in fields, as a way of adapting to the effects of climate change.

Key challenges encountered

Some of the key challenges encountered were:

- Maintaining the interest of organisations that initially wanted to be part of PROLINNOVA–Kenya but retreated when the communities they worked with were not awarded innovation funds;
- Generating in-country funding to replace funds from donors and to reach more farmers;
- High overhead costs, given that the infrastructure and systems had to be set up from scratch and coordinating organisations did not integrate some of the costs in their budgets;
- Negative mindset of many scientists about capacities of smallholders, whose innovations were seen as part of the *jua kali* (informal) sector and therefore not worthy of attention;
- The time needed for participants to reach a common understanding of the LISF concept;
- The efforts needed to strengthen the capacities of LSCs to be able to manage the LISF process in an efficient and sustainable way.

Key lessons and implications for policy

The pilot study showed that smallholders are interested in and willing and able to manage funds for local innovation development. LISF management can be smooth if the roles of the stakeholders are spelt out clearly to avoid duplication or conflict. LISFs work better if their facilitation is integrated into the core activities of the supporting organisations instead of being treated as an add-on activity.

These lessons have implications for policy, such as the need to: i) recognise the contribution of smallholders to ARD and actively link them to formal ARD actors; ii) re-orient formal ARD staff to change their negative mindsets about local innovation; iii) integrate LISFs into national and county budgeting processes so that a revolving fund can support the experiments led by smallholders or an innovation support fund is made a permanent feature of the state budgeting process; and iv) create platforms for mutual learning at district, county and national level about how to enhance innovation processes. To sustain and scale out the LISF mechanism, discussions have started within the NSC and the LSCs about the way forward. Given the new devolved governance structure in Kenya, different counties can develop their own site-specific models of institutionalising PID and its funding. However, there is need to ensure that smallholder farmers remain in control. This could be accomplished through encouraging farmers to present their innovations publicly to increase their self-confidence. In addition, the capacities of intermediaries need to be strengthened in facilitating interaction between farmers and other actors on an equal basis. This will allow an even stronger contribution of smallholders' knowledge to agricultural innovation and enhance their capacities to govern publicly funded ARD.

References

- Kamau G & Almekinders C. 2009. From strangler to nourisher: how novice rice farmers turned challenges into opportunities. In: Sanginga P, Waters-Bayer A, Kaaria S, Njuki J & Wettasinha C (eds), *Innovation Africa: enriching farmers' livelihoods* (London: Earthscan), pp297–310
- Ng'ang'a T & Kamau G. 2013. Farmer Access to Information Resources – Local Innovation Support Funds – Kenya: an information brochure. PROLINNOVA–Kenya, Nairobi (www.prolinnova.net/sites/default/files/documents/Kenya/2012/pkenya_fair_brochure_final.pdf)
- Ng'ang'a T, Righa M, Kamau G, Okello B, Macoloo C, Kirigua V & Njoroge R. 2013. Farmer Access to Innovation Resources (FAIR): Local Innovation Support Fund (LISF) FAIR III: Transition Phase Report. PROLINNOVA–Kenya, Nairobi.
- PROLINNOVA. 2012a. *Farmer Access to Innovation Resources: findings and lessons learnt on facilitating Local Innovation Support Funds*. Leusden: PROLINNOVA International Secretariat, ETC Foundation.
- PROLINNOVA. 2012b. Farmers' direct access to R&D resources accelerates local innovation. Policy brief. Leusden: PROLINNOVA International Secretariat, ETC Foundation.
- Rockefeller Foundation. 2012. Case studies: accelerating innovation for development [Final evaluation report]. New York: Rockefeller Foundation.
- Triomphe B, Wongtschowski M, Krone A, Waters-Bayer A, Lugg D & Veldhuizen L van. 2012. Providing farmers with direct access to innovation funds. In: *Agricultural innovation systems: an investment sourcebook* (Washington DC: World Bank), pp435–441.

Seasonal weather forecasting: integration of indigenous and scientific knowledge

Henry Mahoo¹, Winfred Mbungu¹, Filbert Rwehumbiza¹, Emmanuel Mpeta², Isack Yonah², John Recha³, Maren Radeny^{3*} and James Kinyangi³

¹ Sokoine University of Agriculture (SUA), Morogoro, Tanzania

² Tanzania Meteorological Agency (TMA), Dar es Salaam, Tanzania

³ CGIAR Research Program on Climate Change, Agriculture and Food Security (CCAFS, East Africa, Nairobi, Kenya

* Corresponding author. Email: M.RADENY@cgiar.org

Abstract

In order to address climate change and climate-related risks and improve food security, there is need for downscaled, reliable and timely climate information to inform farm-level decision-making. Despite progress in provision of climate services in Tanzania, significant gaps still exist with regard to downscaled location-specific forecasts and generating timely, reliable and user-friendly information that effectively addresses the needs of the farmers. Consequently, most farmers rely on forecasting using indigenous knowledge (IK). This study identifies and documents existing IK in weather forecasting in Lushoto District, northern Tanzania, with the aim of promoting the integration and utilisation of IK and scientific weather forecasting for risk management. We use historical rainfall data in combination with data collected through household survey, focus-group discussions and key-informant interviews. Most of the farmers (56%) indicated that weather forecasts using IK were more reliable and specific to their location compared to scientific forecasts from the Tanzania Meteorological Agency (TMA). The seasonal March, April and May forecasts in 2012 using IK and the TMA were identical, with the two approaches predicting normal seasonal rains. The IK forecasts were more reliable in the long rainy season (March–May) compared to the short rainy season (October–December). IK is often not documented and mainly sustained from one generation to another through oral history and local expertise, and there is a widening intergenerational gap between the custodians of IK knowledge and the young. There is need for systematic documentation of IK and establishing a framework for integrating IK and weather forecasting from the national meteorological agencies to improve accuracy. In addition, there is need to establish an information dissemination network and to integrate weather forecasting within national agricultural policies and the District Agricultural Development Programmes.

Keywords: climate risks, weather forecasts, indigenous knowledge, smallholder farmers

Introduction

Smallholder farmers in East Africa depend mainly on rainfed agriculture for their livelihoods and are highly vulnerable to climate change and variability. Increased exposure to climate risks coupled with other environmental stresses and low adaptive capacity has significant impacts on agricultural production and food security (SWMRG 2009). The increasing climate variability and climate risks will surpass traditional coping strategies. This highlights the need for downscaled, reliable and timely climate information for farmer decision-making. Despite progress in provision of climate services in East Africa, significant gaps still exist, such as in the type of climate information that effectively addresses the farmers' needs, and location-specific forecasts that can assist farmers to make decisions on when and what to

plant, for example. Consequently, farmers rely on forecasting using indigenous knowledge (IK).

Many rural communities have built up IK on environmental changes over long periods through experimentation and innovation, including strategies to recognise and cope with the changes. Most farmers prefer indigenous forecasting knowledge to forecasting issued by the meteorological agencies (Kadi *et al* 2011). In most cases, IK is more compatible with local culture, location-specific and in a language that can be easily understood by the communities. IK is often not documented and is sustained from one generation to another mainly through oral history and local expertise. Increasing and persistent variability in climate, however, is a major challenge to indigenous weather forecasting. For rural communities to adapt to climate change and cope with climate-related risks, there is need for integration of different types and sources of knowledge. Integration of IK and scientific information is important for improving the knowledge and skills of rural communities for effective planning and action and building resilience to climate change. This study identifies and documents existing IK in weather forecasting in Lushoto District, northern Tanzania. The aim is to promote the integration and utilisation of IK and scientific weather forecasting for improved risk management and food security. The specific objectives of the study were threefold: i) to identify and document existing IK practices in weather forecasting; ii) to establish IK weather forecasting zones and teams; and iii) to promote use of accurate, timely and accessible downscaled consensus seasonal forecasts that integrate IK and scientific information.

Methods

The study was carried out in Lushoto District (Figure 1) by Sokoine University of Agriculture (SUA). Most of the farmers in Lushoto depend on subsistence rainfed agriculture for their livelihood. Average annual rainfall in the district ranges from 400 mm in the lowlands to 1800 mm in the highlands, with a mean annual temperature of 16°C and humidity of 70%.

Data were collected through a survey of 77 households across seven villages spread in three administrative wards (Gari, Kwai and Mbuzii) in Lushoto. The data included information on indicators and reliability of IK, awareness of climate change and variability, sources and access to climate information, occurrence and severity of extreme climate events, risks and vulnerability of different sectors of the economy to climate change. The survey data were complimented with information from key-informant interviews and focus-group discussions carried out in three of the seven villages with people knowledgeable in IK forecasting. Historical rainfall data from the Tanzania Meteorological Agency (TMA) over the period 1920–2011 were used to analyse annual rainfall trends, variability and seasonal characteristics.

Results

The annual rainfall data from the TMA for Lushoto over 90 years show changes in rainfall patterns with increasing variability and a general decreasing trend (Figure 2). The bimodal seasonal rainfall pattern in Figure 3 shows that the long rainy season occurs from March to mid-June and the short rainy season in October–December. Changes in the annual rainfall amounts received during both seasons are clearly evident (Figure 3), with a slight shift towards late onset and early cessation of the rains. The risk of having dry spells longer than 10, 15 or 20 days during the rainy season is below 50% at the peak of both the short and the long rainy seasons (Figure 4). The risk of having longer dry spells increases gradually before and after the peak of the rainy season.

Country: Tanzania

CCAFS Sampling Frame: Usambara - Lushoto

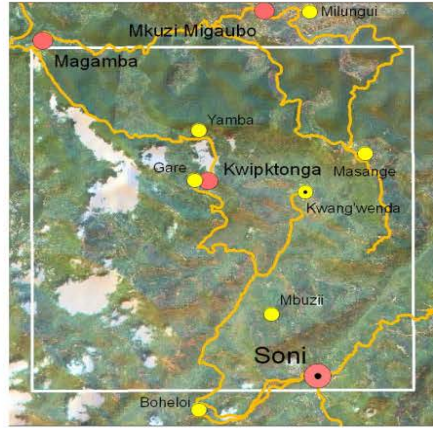
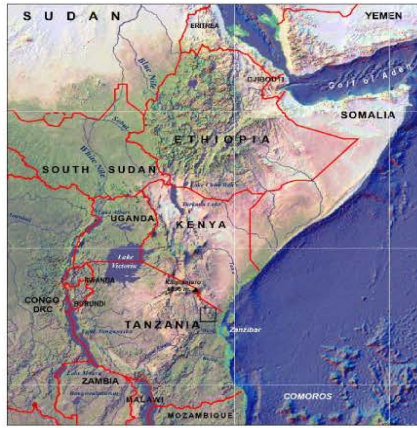

CCAFS Site Name (ID): Usambara (TZ01)
 CCAFS Sampling Frame Name (ID): Lushoto (05)

- Town
- Settlement
- Road
- CCAFS VBS / OBS Village
- CCAFS HBS Village

Coordinates of the CCAFS Sampling frame

38.417E	4.790S
38.417E	4.850S
38.301E	4.850S
38.301E	4.790S

□ Site location

Topography Usambara Site (TZ01), Tanzania

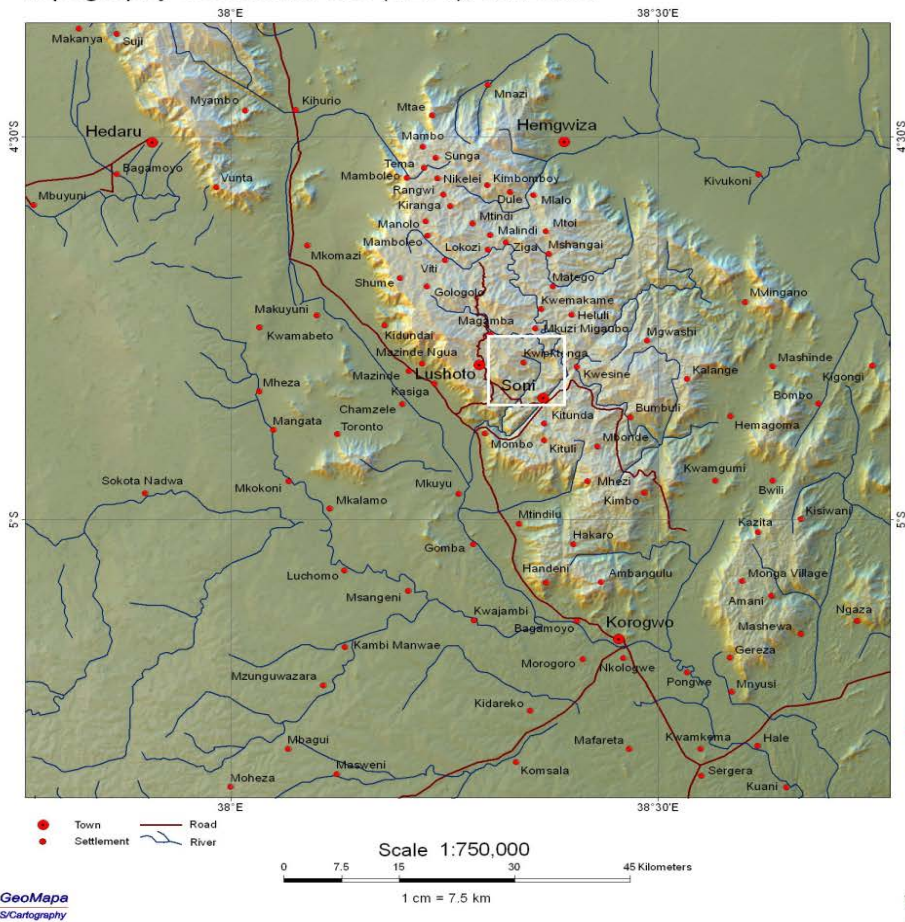

Figure 1: Lushoto site map (Source: CCAFS site portfolio, 2013)

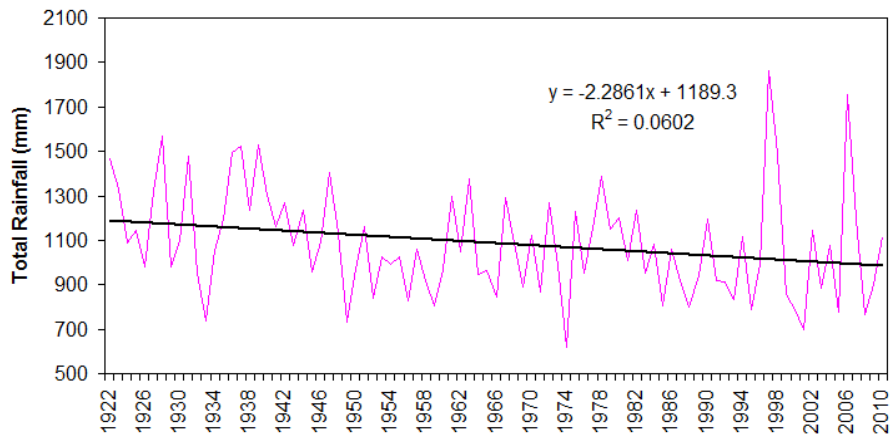

Figure 2: Lushoto long-term annual rainfall trend for the years 1920–2011 (Source: TMA)

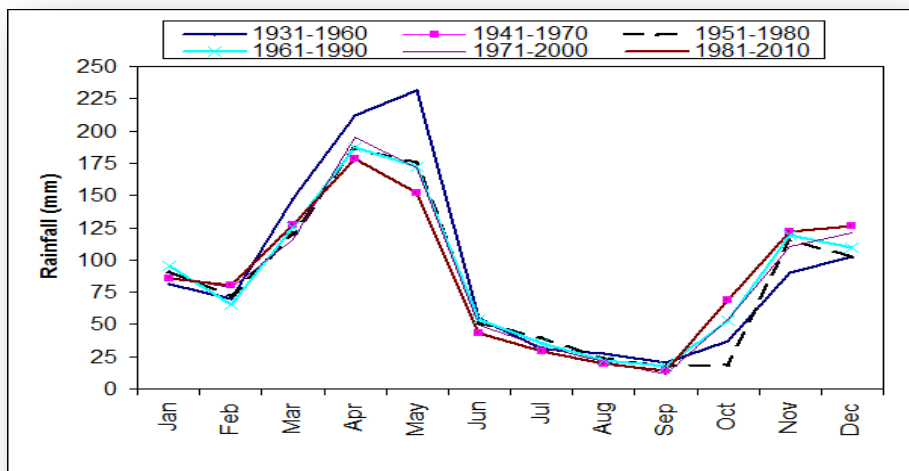

Figure 3: Comparison of thirty-year period monthly rainfall patterns (Source: TMA)

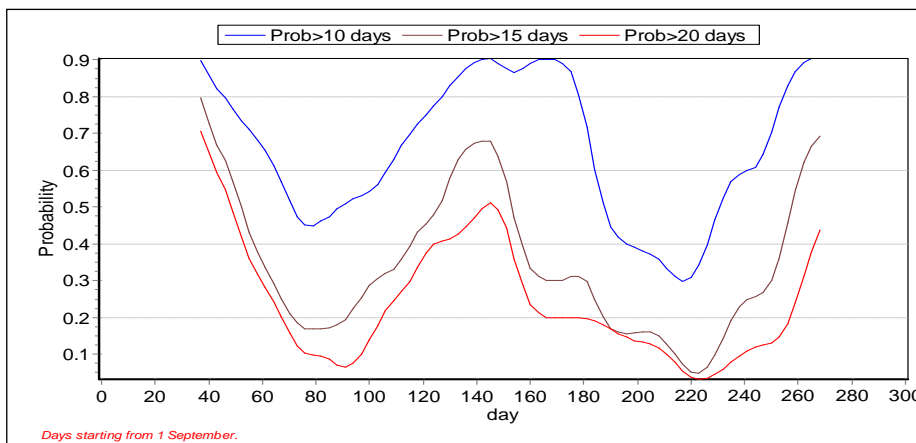

Figure 4: Dry spell probability (risks) in Lushoto (Source: TMA)

Notes: Day 1 = 1 Sept/, Day 85 = November 24 (mid-short rainy season), Day 220 = 6 April 6 (mid-long rainy season).

The results show that unpredictable onset and cessation of rainfall, frequent drought, and crop pests and diseases were the most important climate-related risks. In order to manage these risks, timely and accurate weather forecasts are needed to inform farm-level decision-making. The majority of the farmers (68%) observe the weather on their own using IK, even though

61% of them access scientific weather information from the TMA through the radio (Figure 5). While the TMA provides daily, monthly and seasonal forecasts, only a few farmers (22%) indicated the forecasts were reliable, with 38% indicating the forecasts were not reliable. About 40% of the respondents were uncertain and thought that the forecasts were just somewhat reliable.

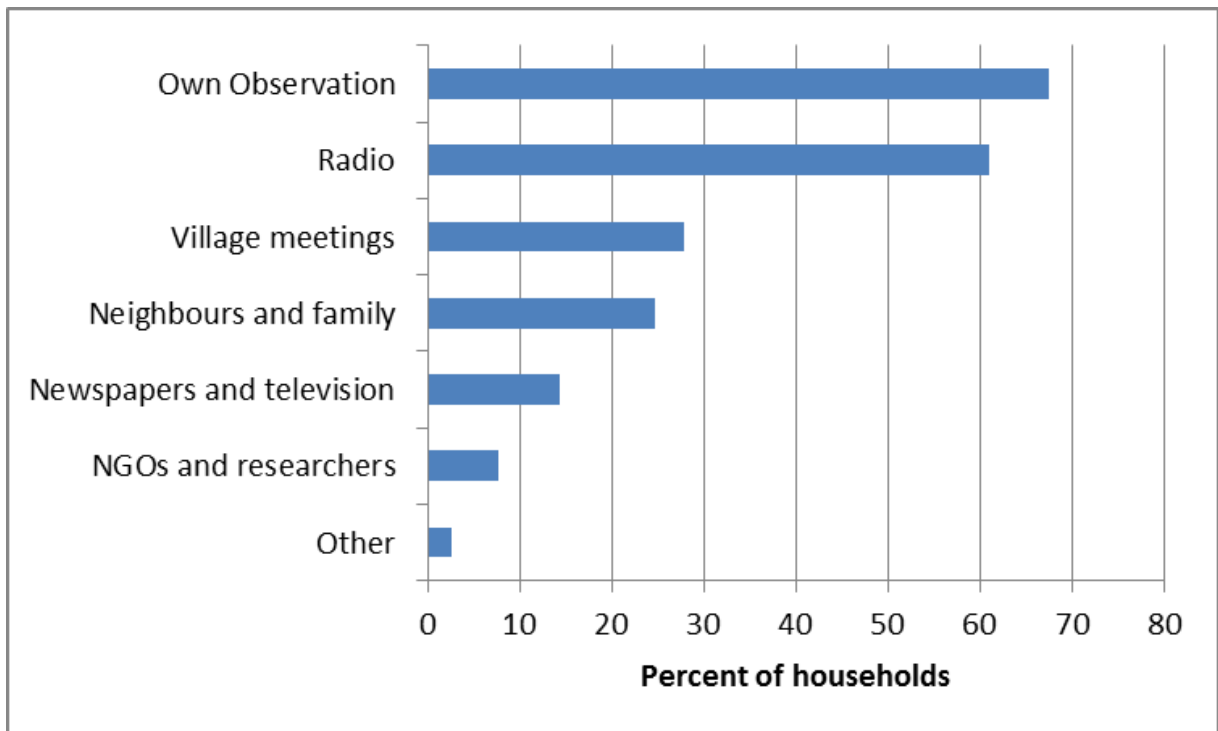

Figure 5: Sources of information on weather and seasonal forecasts

The IK is not widely documented and custodians pass it from one generation to another. Observations are made on plants, wild and domestic animals, insects, birds, wind, air temperature, cloud formation, the stars and moon for prediction (Galacgac & Balisacan 2009, Chang'a *et al* 2010, Acharya 2011, Egeru 2012). The most common IK indicators in Lushoto were birds (swallows, hornbills, owls, coucals and golden orioles), animals (baboons, monkeys and antelopes), insects (thrips, ants, bees, locusts and butterflies), shrubs and trees. Most of the farmers (56%) believed that the IK forecasts were reliable, 28% reported the forecasts to be somehow reliable and 16% thought they were not reliable. For those who relied on IK, they all reported that the long rainy season is usually more easily predictable because of conspicuous indications from the predictors, compared to the short rainy season.

Three local IK forecasting teams of seven persons were set up for each administrative ward. The teams meet twice a month to discuss and document the IK weather forecast observations. During the meetings, they give two-week forecasts for the wards and provide recommendations on farm-level decisions that are disseminated to the local farmers. These three groups are now part of a newly established Lushoto District weather forecasting team consisting of 29 people in total. Other members include the Lushoto District Agricultural and Livestock Development Officer (DALDO) as the chairperson, five agricultural extension officers from the wards, and SUA and MTA representatives. The district forecasting team considers IK weather forecasts on a 14-day basis, and science-based weather forecasts from the TMA. The team produces consensus forecasts that integrate IK and scientific weather information from the TMA, and disseminates the consensus weather forecast to all stakeholders in the district. The district forecasting team meets four times a year before the start and at the end of the each rainy season. For the 2012 long rainy season (March–May),

there was no need of a consensus forecast because the IK teams forecast a normal rainfall season with 90% accuracy, in agreement with the scientific forecast from the TMA.

Key challenges

Lack of documentation and reliability are among the key challenges in using IK forecasts. IK is mainly sustained from one generation to another through oral history and local expertise, and there is a widening intergenerational gap between the custodians of IK knowledge and the young. In order to sustain and improve IK for use by future generations, there is need for systematic documentation of IK. In Lushoto, the results show that IK forecasts were more reliable in the long rainy season compared to the short rainy season (October–December). With the increasing changes in weather patterns and variability, IK in weather forecasting needs to be strengthened and integrated with scientific weather information. The seasonal weather forecasts from the TMA sometimes come later in the season after the IK weather forecasts has already been released in the villages and farmers have already made decisions.

Key lessons, recommendations and conclusions

The multistakeholder partnership involving the local community, agricultural extension services and the TMA for the district consensus weather forecasting is important for improving the provision of climate information services in Lushoto. There is need for systematic documentation of IK and establishing a framework for integrating IK and scientific weather forecasting from the meteorological agency to improve accuracy. Establishment of an information dissemination network that provides information to all farmers beyond the three administrative wards is important, as all the farmers in the district need to manage climate-related risks. This could be achieved by integrating systems for disseminating climate information within the local communities, e.g. through the local schools, community-based organisation, churches in highly religious communities, partnership with NGOs and agricultural input dealers and service providers. Integration of weather forecasting into the national agricultural policies and District Agricultural Development Programmes (DADPs) would greatly enhance climate-smart agriculture for food security, as it would lead to better-informed decisions at farm level. Besides, there is a need to translate the consensus weather forecasts into the native language for easier understanding by the majority of the farmers who are illiterate. For a comprehensive weather forecast, there is need to integrate the IK and scientific weather forecasts by having local IK custodians work with the TMA officers.

References

- Acharya S. 2011. Prediction of rainfall variation through flowering phenology of night-flowering jasmine (*Nyctanthesarbor-tristis* L. Verbenaceae) in Tripura. *Indian Journal of Traditional Knowledge* 10 (1): 96–101.
- Chang'a LB, Yanda PZ & Ngana J. 2010. Indigenous knowledge in seasonal rainfall prediction in Tanzania: a case of the South-western Highland of Tanzania. *Journal of Geography and Regional Planning* 3 (4): 66–72
- Egeru A. 2012. Role of indigenous knowledge in climate change adaptation: a case study of Teso Sub-Region in eastern Uganda. *Indian Journal of Traditional Knowledge* 11 (2): 217–224.
- Galacgac ES & Balisacan CM. 2009. Traditional weather forecasting for sustainable agroforestry practices in Ilocos Norte Province, Philippines. *Forest Ecology and Management* 257: 2044–2053.
- Kadi M, Njau LN, Mwikya J & Kanga A. 2011. The state of climate information services in East African countries. CCAFS Working Paper 5. Copenhagen: CCAFS (www.ccafs.cgiar.org).
- SWMRG (Soil-Water Management Research Group). 2010. *Economics of climate change for agriculture sector in Tanzania: adaptation options and their costs*. London: International Institute for Environment and Development (IIED).

Broad versus specific agricultural recommendations: implications for research and policy

Maxwell Mkondiwa^{1*} and Richard Coe²

¹ *Centre for Agricultural Research and Development, Malawi*

² *University of Reading Statistical Services Centre, UK*

* Corresponding author. Email: maxwellmkondiwa@gmail.com

Abstract

The emerging picture from reviewing literature on research recommendations in Southern Africa is that attempts have not been made to measure the intangible costs and benefits of various innovation systems for generating locally adapted technologies (e.g. social costs and benefits of farmers who engage in a participatory variety trial). In addition, policy incentives through input and output market support have increased the use of broad recommendations due to poor targeting, politics of patronage and weak extension systems. Some of the policy ramifications for improving agricultural innovation systems taking into account scale of recommendations include: i) decentralising technology registration and release through more capacity building of extension and local change agents to facilitate local adaptive research; ii) aiming to scale up principles and understanding of processes to form the basis of local adaptive research rather than scaling up or publishing finished recommendations; and iii) increasing research effort to understand exactly what the interactions with context are and the costs and benefits of various recommendations (broad versus specific) under different scale and risk scenarios.

Keywords: *recommendations, policy, fertiliser, farmer heterogeneity, Southern Africa*

Introduction

Low soil fertility is one of the major biophysical constraints to increasing agricultural productivity in sub-Saharan Africa (Ajayi *et al* 2007). Soil fertility improvement has therefore been the main area in which issues of area-specific recommendations have been widely addressed in Southern Africa as a way of improving yields and efficiency. In the 1980s and '90s, the emphasis in Africa was on developing inorganic fertiliser recommendations that provide profitable and optimal yields to smallholder farmers. Fertiliser recommendations were often based on nutrient response trials that were conducted many decades ago and on a rather limited range of trials in relatively few locations. In many countries, standard or blanket recommendations apply the same rules for whole agro-ecological regions or, in some cases, across the whole country. Comparing these recommended rates with application rates currently used by small-scale farmers reveals complete lack of relationship (Vanlauwe & Giller 2006). Guidelines for fertiliser use need to be flexible. Guidelines should also be related to the likely production within the season because of the variation in climate (particularly rainfall) that determines the potential for crop production in any given season.

Generally, two common observations are made regarding African smallholder farming systems: i) they are very heterogeneous; the ecological and socio-economic context varies even in small areas and farmers have diverse needs and objectives; ii) the recommendations for appropriate practices interact with context, so must be locally adapted. Several examples of practices and approaches demonstrate this understanding of farmer heterogeneity and context. These include: developing area-specific fertiliser recommendations that take into account variation in soils and other conditions, and participatory plant breeding for local

adaptability. However, common practice and policy are still built on the assumption of uniformity. Examples include: fertiliser and other recommendations published without reference to context and made at national scale; national systems for variety registration and release that require broad adaptation; and trying to scale up technology packages that have proved useful in one location.

The central question we address is why this divergence between knowledge and practice exists. What are the costs, benefits and mechanisms for generating local recommendations and how do these compare with the conventional research and development (R&D) systems that are built on an assumption of uniformity?

Materials and methods

A scoping study aimed at developing a research agenda to investigate this question is reviewing the current concepts, practices and policies on broad versus specific agricultural recommendations. We use soil fertility management in Southern Africa (Malawi in particular) as the motivating example.

Highlights of main results

Costs and benefits of local recommendations

Moreddu (2007) makes a comprehensive analysis of the costs and benefits associated with targeting or applying local recommendations to specific niches. The report argues that a more targeted policy (or local recommendation) is expected to achieve a given result with lower transfers than a broad-based policy (or broad recommendation). However, targeted policies have higher transaction costs per unit of transfers (hectares or recipients) than broad-based policies. This is because fixed costs are spread over a smaller number of farmers (i.e. lower economies of scale) and because additional costs are involved in identifying the target variables, population and area.

In addition, the costs of local recommendations vary with the degree of targeting (fineness of the local recommendation). It is argued that the finer the targeting, the higher the costs of administration and the greater the hidden costs. Conceptually, however, this is followed by greater benefits assuming increasing marginal benefits.

In a more empirical study, Houssou and Zeller (2011) used simulation to compare indicator-based targeting in input provision and universal systems. The results suggest that targeting Malawi's poor and smallholder farmers is worth the extra effort because it is cost efficient although administrative costs increase. The administrative costs do not make a targeted policy cost ineffective. Table 1 shows the potential costs and benefits of targeting recommendations to specific socio-ecological niches. In the literature so far, we did not find papers that consider the social costs and benefits of a targeted policy (or local recommendation), which is very important considering the policy landscape in Southern Africa.

Research and policy paradox

The Maize Productivity Task Force in the Malawi Ministry of Agriculture implemented countrywide fertiliser verification trials during the 1995/96 and 1997/98 growing seasons. The trials were aimed at developing area-specific recommendations that were expected to lead to higher maize yields. Analysis of the trials led to development of localised fertiliser recommendations for hybrid maize. A decision tree was also drawn up to help fieldstaff in implementing the new recommendations, drawing on results of the trials on farmers' fields.

Table 1: Potential costs and benefits of local/specific research recommendations

Study	R&D stage	Potential costs	Potential benefits (local)
Shiferaw <i>et al</i> (2008)	Research lag of 9 years Adoption lag of 7 years 9 years of abandoning technology	Costs for research, adaptation and extension Estimated costs of both national and international scientists and staff	Example: on average, farmers adopting new varieties have 80% higher net income/ha from pigeonpea production than non-adopting farmers, showing the extent of benefits that farmers may derive if they switch to disease-resistant new varieties
Moreddu (2007)	Policy and implementation	Significant implementation (or policy-related transaction costs) High transaction costs per unit of transfers (e.g. ha, recipient) Requires specific information & expertise Time to reach consensus on what a local recommendation is High transaction costs to farmers but depends on delivery systems Costs of policy contradictions as a local recommendation is applied within a set of other broad-based policies	Address specific needs in specific areas to intended subjects (effective redistribution) Large savings
	Research or diagnosis	Additional costs to identify target variables, population, area, explain requirements of the local recommendation and ensure compliance	Benefits from coordination & capacity-building initiatives (i.e. better trained extension staff)
Houssou & Zeller (2011)	Policy and implementation	Costs of transfer to the poor (in context of local recommendations implies costs associated with a local recommendation that is slightly above the threshold) Costs of leakage to other areas requiring a different local recommendation (as result of spillovers & knowledge-sharing among farmers) High administrative costs (includes costs of developing recommendation) High hidden costs (private, indirect, social and political) Costs of regular screening Costs of processing and delivering Staff costs	High benefits due to efficiency gains

Information generated in countrywide verification trials was incorporated into the design of a small package of improved seed and fertiliser distributed to almost every rural household under Malawi's "starter pack" programme (Snapp *et al* 2003). In a review of fertiliser policies since 1964 by Johnson & Birner (2013), there is ample evidence of a disconnect between the recommendations generated and the resultant policies. The modified table (Table 2) from Johnson & Birner (2013) and Snapp *et al* (2003) shows that research from the countrywide verification trials had a role in the policy orientation towards the starter pack. However, political innuendos and droughts in 2001/2 and 2004/5 affected its implementation. It is evident that the policy decisions over time have largely depended on the political landscape, the occurrence of droughts and famines, and donor influence.

Table 2: Fertiliser and input policy interventions in Malawi, 1950s–2012

Phases	Policy orientation		Exogenous factors	Research	
	Programme & duration	Components	Shocks/crises/events	Role of research and changes in recommendations	Research into area-specific recommendations
1950s–1979	Marketing Board (ADMARC) ¹³	Procurement and provision of seeds and fertiliser; pan-territorial pricing including subsidised inputs	Macro-economic imbalances	Area-specific recommendations for fertiliser rates developed (N-30-90kg/ha, P-0-40kg/ha)	Countrywide fertiliser response trials and soil testing in 1950s
1979–1998	ADMARC liberalisation Agricultural Productivity Investment Program 1997/98	Smallholder Fertilizer Revolving Fund (1981–86) Subsidies eliminated by 1995/96 Fertilizer Subsidy Removal Program Fertiliser and seed on credit	Structural Adjustment Programs (IMF/World Bank) Drought in 1986/87 season	Area-specific recommendation replaced by a blanket recommendation (not based on research)	FAO support for fertiliser verification trials. Farming systems teams implemented with extensive training with Rockefeller Foundation and World Bank support
1999–2004	Starter Pack Program I and II (1999/2000 and 2000/01)	Free distribution of fertiliser and other inputs to 2.86 million beneficiaries	Earlier droughts (1992, 1994, 1998) in addition to war in Mozambique. Government forms Food Security Task Force	Major role in development of starter pack and recommendations	European Union and other donors; Sasakawa Global 2000 starts countrywide demonstrations of high rates of fertiliser Sasakawa Global 2000 input used to revise starter pack, based on Nigerian recommendation for maize spacing, population density and fertiliser rate
	Targeted Input Program (2000/01–2004/05)	Scaled-down version of starter pack	IMF restrictions on Government contribution, giving more leverage to donors to scale down		
2005–2012	Agricultural Input Subsidy Program (2005/06 to now)	Fertiliser and seeds (maize and non-maize) to identified smallholders through voucher system	Elections and new leadership	Minor role, mostly for impact-assessment study, funded by donors	2009 to date Agricultural Sector-Wide Approach technology countrywide demonstration trials
	Input for Assets under IRLADP ¹⁴ (2006/07 to now)	Fertiliser and seeds to community-identified beneficiaries			

Sources: Johnson & Birner (2013) and Snapp *et al* (2003)

¹³ ADMARC: Agricultural Development and Marketing Corporation

¹⁴ IRLADP: Irrigation, Rural Livelihoods and Agricultural Development Project

Key challenges met

The review had some limitations:

- Sparseness of spatially explicit multilocation and multiseason trial data needed to understand the use of recommendations (local versus broad);
- The effect of politics and institutional factors are difficult to factor in when considering whether a local and specific recommendation is effective.

Key lessons and recommendations

Some of the policy ramifications for improving agricultural innovation systems taking into account scale of recommendations include:

- Decentralise technology registration and release through building capacity of extension and local change agents to facilitate local adaptive research;
- Aim to scale up principles and understanding of processes to form the basis of local adaptive research rather than scaling up or publishing finished recommendations; and
- Increase research effort to understand interactions with context: social costs and benefits of various recommendations (broad versus specific) under different scale and risk scenarios.

Conclusions

It is evident from the review that research on recommendations has not attempted to measure the intangible costs and benefits of various innovation systems for generating locally adapted technologies. Policy incentives through input and output market support have increased the use of broad recommendations due to poor targeting, politics of patronage and weak extension systems. The experience from Malawi demonstrates the importance of assessing the political and institutional landscape when considering the application of research recommendations. In addition, all other exogenous factors including natural disasters and climate should be thoroughly considered.

References

- Ajayi OC, Akinnifesi FK, Sileshi G & Chakaredza S. 2007. Adoption of renewable soil fertility replenishment technologies in the southern African region: lessons learnt and the way forward. *Natural Resources Forum* 31: 306-317.
- Houssou N & Zeller M. 2011. To target or not to target? Costs, benefits and impacts of indicator based targeting. *Food Policy* 36: 627-637.
- Johnson M & Birner R. 2013. *Understanding the role of research in the evolution of fertilizer policies in Malawi*. Washington DC: IFPRI.
- Moreddu C. 2007. *Effective targeting of agricultural policies: best practices for policy design and implementation*. OECD Publications.
- Shiferaw BA, Kebede TA & You L. 2008. Technology adoption under seed access constraints and the economic impacts of improved pigeonpea varieties in Tanzania, *Agricultural Economics* 39: 309-323. doi:10.1111/j.1574-0862.2008.00335.x
- Snapp SS, Blackie MJ & Donovan C. 2003. Realigning research and extension to focus on farmers' constraints and opportunities. *Food Policy* 28: 349-363.
- Vanlauwe B & Giller KE. 2006. Popular myths around soil fertility management in sub-Saharan Africa. *Agriculture, Ecosystems and Environment* 116: 34-46.

Upscaling the orange-fleshed sweetpotato in East and Central Africa

Margaret McEwan¹ and Sarah Mayanja^{2*}

¹ *International Potato Center, Sub-Saharan Africa, Kampala, Uganda*

² *International Potato Center, Sub-Saharan Africa, Nairobi, Kenya*

* Corresponding author. Email: s.mayanja@cgiar.org

Abstract

The Orange-Fleshed Sweetpotato (OFSP) is a wonder crop – 125 g supply the recommended daily vitamin A for a child below five years of age. This would combat vitamin A deficiency, estimated in 27 million children in East and Central Africa. However, OFSP has not readily been available among resource-poor farmers. The Dissemination of New Agricultural Technologies in Africa (DONATA) project aimed at popularising OFSP uptake and utilisation in Ethiopia, Kenya, Rwanda, Tanzania and Uganda.

The project employed a multistakeholder approach to promote proven OFSP technologies. Twenty Innovation Platforms for Technology Adoption (IPTAs) comprising national agricultural research institutions, non-governmental organisations, farmer organisations, the private sector and extension agents availed vines, roots and processed products along the production-consumption continuum.

The project addressed availability of quality seed through a three-tier seed system. Twelve varieties were disseminated to 100,000 farmers. About 26,000 farmers and 1040 trainers of trainers were trained in agronomy, processing and marketing technologies. This led to increased production and marketing of OFSP products, envisaged by fulfilment of ten contracts. Over 500,000 people were sensitised through the media, schools, hospitals, field days and exhibitions.

The initial narrow focus of the IPTAs was a challenge addressed through value-chain development. Other challenges included: institutional rules of leading organisations, which curtailed the IPTA process; loss of key members on platforms and limited activity monitoring. Lessons learnt include harmonising and leveling IPTA member expectations, and the importance of the media and traders on the platform. Future applications would benefit from adopting gender-transformative approaches within IPTAs and value chains.

Keywords: *innovation platforms, sweetpotato, value chains*

Introduction

The pro-vitamin A rich Orange-Fleshed SweetPotato (OFSP) is a wonder crop – only 125 g is needed to supply the daily recommended intake of vitamin A for a child below five years and non-lactating women (HarvestPlus 2010). Even at low yield levels (e.g. 5 tons/ha), a family of five can obtain their annual supply of vitamin A from a 500m² (0.05 ha) plot (HarvestPlus 2010). In addition, vine tops have excellent micronutrient content and adequate protein for use as feed or food. Also, sweetpotato produces more food per unit area per unit time than other major staples, tolerates occasional dry spells and yields even on less fertile soils (Woolfe 1992). OFSP is hence an important source in combating vitamin A deficiency, estimated in 27 million children in Eastern and Central Africa (ECA) in 2007, with a prevalence of around 40% (UNSCN 2010). Levels of vitamin A deficiency are highest in drier areas, where the diversity of micronutrient-rich foods is lowest. However, OFSP has not readily been available among resource-poor farmers where it is needed most. The Dissemination of New Agricultural Technologies in Africa (DONATA) project hence aimed at popularising OFSP uptake and utilisation in Ethiopia, Kenya, Rwanda, Tanzania and

Uganda. The 5-year project (2008–13) used a multistakeholder approach to transfer and promote proven technologies for production, processing, storage and marketing of OFSP. Twenty Innovation Platforms for Technology Adoption (IPTAs) comprising national agricultural research institutions (NARIs), non-governmental organisations, farmer organisations, the private sector and extension agents were formed and worked to increase availability of vines, roots and processed products along the production-to-consumption continuum. The specific objectives of the project included:

- Enhanced uptake of OFSP technologies and innovations in Ethiopia, Kenya, Rwanda, Tanzania and Uganda
- Strengthened capacities for disseminating and scaling up OFSP innovations in the production-to-consumption continuum in ECA
- Enhanced availability of information on OFSP innovations and uptake approaches to stakeholders in ECA.

The IPTA approach enabled achievement of the objectives through transfer and promotion of proven, available and emerging technologies for production, storage and processing of OFSP into higher-value products, development of agro-enterprises and linking farmers to markets.

Materials and methods

The NARIs spearheaded the formation of IPTAs in all countries, except in Gulu, Uganda where the university oversaw the process. The International Potato Center (CIP) provided technical backstopping. The NARIs identified potential research and development actors and invited them to join the IPTA. The IPTAs developed vision and mission statements that guided their work, and convened regularly to plan and review activities and strategies to promote OFSP. This was further augmented by delegation and harmonisation of roles, responsibilities and expectations. The IPTAs also sought expert support (where absent) in developing seed systems, production plans, value addition and marketing strategies. While there were differences in mandate and scope among the IPTAs, most of them focused on the entire value chain. By the close of project, 20 IPTAs were functional: two in Ethiopia, three in Kenya, four in Rwanda, nine in Tanzania and two in Uganda.

Main results

One of the greatest achievements was addressing the availability of quality seed at planting time. IPTAs supported establishment of 240 ha of multiplication sites. This was done using a three-tier system: i) Primary Multiplication Sites, which were established at NARIs and provided clean starter seed to the next levels; ii) Secondary Multiplication Sites, which were managed by farmer groups or entrepreneurs; and iii) Tertiary Multiplication Sites (TMSs) at individual farmer level. The hypothesis was that availability of planting material of adequate quality at the onset of rains would lead to early planting and increase the volume of fresh roots as well as providing raw material for processed products to satisfy market demand (Ndolo *et al* 2012). Seed was not only of high quality due to close supervision from research and the IPTA members, but was usually readily accessible in farming communities where the TMSs were based. In Kenya, for example, this enabled farmers to produce roots twice a year, whereas previously the first season was normally used to multiply vines for the second season. However, loss of seed was experienced due to drought, as was the case in Tanzania and Ethiopia. In Ethiopia, private seed multipliers greatly augmented disaster and relief management efforts after prolonged drought, through timely provision of seed to farmers, especially in incidences where TMSs had been wiped out.

A number of technologies were disseminated and adopted. These included agronomic practices for seed and root production, e.g. rapid multiplication techniques, vine conservation, disease identification and management, as well as value-addition technologies such as OFSP flour, snack foods, baked products and juices in addition to boiled and fried

fresh roots. Processing units were established in Kenya, Tanzania, Rwanda and Uganda, while small-scale sweetpotato processing equipment for promotion and demonstration including peelers, chippers and slicers were piloted and adopted in all countries. Marketing technologies promoted included establishment of sales points, bulking centres and commercial villages, among others. While the bulking points still need consolidation, these technologies led to increased production and productivity as well as quality of the various OFSP products including vines, roots and processed snacks.

The IPTAs built capacity of its members and actors in the value chain through a multipronged capacity-building strategy: 1040 trainers of trainers were trained in a broad range of themes including seed production and management, agronomy, postharvest handling and processing, entrepreneurship, collective action and marketing, among others. In turn, the trainers trained farmers and other stakeholders and this cascaded down to 26,000 farmers and 74 agroprocessors and 95 extension personnel. Sixty-four IPTA members were also given formal training in agricultural innovations systems and value-chain development in a bid to improve marketing facilitation skills. Five MSc students were sponsored and their theses focused on improving OFSP production and value addition. The improved capacity was manifested in the IPTAs being able to address challenges impeding visibility of OFSP. Following the training in AIS, the IPTA members in Rwanda decided to redesign the existing IPTAs to take on a geographical focus, hence increasing the number from two to four, which increased uptake of OFSP technologies. IPTAs in Kenya and Tanzania were able to scan the environment for marketing opportunities and devise strategies to address them. Generally, the quality of OFSP processed products improved as gauged from the improved consumer acceptability from the taste-tests performed in Rwanda and the increased demand. The IPTAs were able to successfully negotiate and conclude over ten contracts for vines, roots and processed products worth over USD 200,000. Vines that hitherto were given or exchanged freely have now gained commercial value and are sought for in the region.

There was increased awareness of OFSP in the five countries, resulting from a concerted effort of the IPTAs to develop and disseminate knowledge products through innovative pathways. The information, education and communication materials included training manuals, recipe books, leaflets and brochure, calendars, radio/TV scripts, websites and knowledge portals. These were disseminated during exhibitions, field days, agricultural shows, drama shows, radio/TV shows, farmer meetings and also at schools, health centres and barazas, among others. Promotional materials including umbrellas, aprons and bags were also distributed. As a result, over 500,000 stakeholders including actors in the value chain, chain supporters and policymakers were reached. Wide awareness creation enabled advocacy for support from policymakers to further the OFSP agenda. In Rwanda, for example, OFSP vine multiplication was allowed in wetlands previously gazetted for “priority” crops.

Key challenges

Initially, several IPTAs focused on just one segment of the OFSP chain, with an aim of specialisation. They later realised the need to broaden their outlook owing to the need to address the challenges in production, processing and marketing. This also meant that the IPTAs had to source for expert capacity to address the upper stream of the chain, which was done through engaging consultants or technical experts from CIP. In some countries, the IPTA process did not take off immediately on account of institutional rules that barred NARIs from transferring funds to other stakeholders for activity implementation. Loss of key members on the platform was another challenge, especially as a result of transfer, study leave or departure of the member from the partner institution. The IPTAs struggled to address this through scouting for replacements, but in any case this was not very easy. Harmonising roles and expectations of IPTA members was another challenge, which was addressed through sensitisation and support from institutional development experts. Other challenges were

related to weather, e.g. drought as experienced in Ethiopia and Tanzania, and limited monitoring of project activities because of funding constraints (CIP 2008–13).

Key lessons and recommendations for research, policy and practice

The key lessons learnt include:

- *Dynamism through the value chain:* The early years of the project were driven by the need to ensure availability and access to sufficient quantities of planting material. As increased availability of planting material translated into increased root production, concerns about market linkages preoccupied the IPTAs. This resulted in different types of actors becoming involved in the IPTAs (processors, traders, business development services and consumer protection bodies). Many of the IPTAs were able to encourage and embrace these new members.
- *Positive role of media:* The media played a great role in sensitising farmers and the general public on the importance of OFSP. In Uganda, Mega FM played an exceptional role in linking buyers of roots and vines to sellers.
- *Seed business models:* While farmers are now buying seed, seed business models that are likely to succeed will either be mixed livelihood or social enterprise models. Such entrepreneurs will be driven not only by profit but also by the desire to do good for others and could, for example, provide starter seed to new farmers or link other seed growers to markets at no extra cost (McEwan 2013).
- *Need for better food hygiene:* OFSP processed products and snacks will still require additional support to improve food hygiene to be eligible for quality certification.
- *Benefits for vulnerable groups:* OFSP has significantly contributed to improved health of vulnerable groups, e.g. children and people living with HIV/AIDS.
- *Need for attention to gender issues:* Future applications of this approach would benefit from gender transformative approaches within the IPTA and the value chain in context.

Conclusions

Innovations platforms can enhance uptake and dissemination of technologies because these platforms involve multilevel, multistakeholder interactions that facilitate identification, understanding and addressing of complex challenges. Their performance greatly depends on their institutional setup, which determines their ability to respond to changes (e.g. in demand and supply) within the environment, which would dictate their ability to remain relevant in the long haul.

References

- CIP. 2008–13. DONATA quarterly technical reports. International Potato Center (CIP).
- HarvestPlus. 2010. HarvestPlus statement on potential benefits of biofortification on nutritional status of populations, HarvestPlus.
- McEwan M. 2013. Sweetpotato Seed Systems in sub-Saharan Africa: a literature review to contribute to the preparation of conceptual frameworks to guide practical interventions for root, tuber and banana seed systems. Nairobi: CGIAR Research Program on Roots, Tubers and Bananas.
- Ndolo PJ, Akhwale M, McEwan M, Mayanja S & Nabwisa G. 2012. Sustainable sweetpotato seed systems in Western Kenya: myth or reality? Poster presented at the 3rd Annual Sweetpotato Profit and Health Initiative Technical Meeting. Nairobi.
- Sommer A & West KP. 1996. *Vitamin A deficiency: health, survival and vision*. New York: Oxford University Press.
- UNSCN. 2010. *Progress in nutrition: 6th report on the world nutrition situation*. Geneva: United Nations Standing Committee on Nutrition (UNSCN).
- Woolfe J. 1992. *Sweet potato: an untapped resource*. Cambridge: Cambridge University Press.

Value-chain development in Uganda: lessons learnt from the Participatory Market Chain Approach (PMCA)

Sarah Mayanja^{1*}, Beatrice Akello², Douglas Horton³, Dan Kisauzi⁴ and Damalie Magala⁵

¹ *International Potato Center, Sub-Saharan Africa, Kampala, Uganda*

² *National Agricultural Research Institute, National Semi-Arid Resources Research Institution, Soroti, Uganda*

³ *Independent consultant, Sarasota, Florida, USA*

⁴ *Nkola Institutional Development Associates, Kampala, Uganda*

⁵ *National Agricultural Research Institute, Mukono Zonal Agricultural Research and Development Institute, Mukono, Uganda*

* Corresponding author. Email: s.mayanja@cgiar.org

Abstract

In Uganda and elsewhere, smallholders face barriers hindering their effective participation in dynamic markets. These include financial capital, business skills, organisation and market intelligence. The International Potato Center (CIP) developed the Participatory Market Chain Approach (PMCA), which increases trust, confidence and linkages among chain actors, stimulating innovations and improving market access for smallholder farmers. Through South–South collaboration, PMCA was applied in the potato, sweetpotato and vegetable chains in Uganda in 2007. The present CIP study assesses results of PMCA in Uganda in the context of a global study of PMCA applications. Interviews with chain actors, facilitators, researchers and policymakers indicate that PMCA contributed to knowledge and skills, social networks and capacity to innovate. Chain actors generated commercial, technological and institutional innovations. Some, such as tomato sauce, remained in the prototype phase; others, such as the orange-fleshed sweetpotato crisps, gained commercial viability but disappeared from the market; while others, such as the vegetable appetiser, are present in the market. PMCA stimulated “second-generation” innovations that improved the original ones. The social networks developed have facilitated business development. Women farmers improved their access to markets and earnings, and acquired productive assets, including land. Several organisations have used the PMCA in training, curriculum development and market-chain development. Notably, Uganda’s Ministry of Agriculture has adopted the value-chain approach in its Development Plan. Emerging lessons include need for: business development support after PMCA; synchronising production to demand; and a “seed” fund to support emerging innovations.

Keywords: *value-chain analysis, market chain, social capital, networks, innovation*

Introduction

Agricultural markets play an important role in the economy and livelihood of rural people in developing nations. In the economy of Uganda, agriculture accounts for over 20% of GDP (Uganda Bureau of Statistics 2009) and employs three-quarters of the labour force (Republic of Uganda 2010). The sector is weakly integrated with other sectors such as manufacturing (Juma 2011), as shown by farmers’ inability to respond effectively to market demand. Market intermediaries and other chain actors, on the other hand, are frustrated by high transaction costs, small volumes and uneven quality of supplies of agricultural produce, which hamper their operations. This is detrimental to the growth and development of agricultural markets.

Two broad strategies have been proposed to remedy this situation: i) strengthening relations between the value-chain actors; and ii) strengthening standards, regulations, policies and services to coordinate and support trading activities (KIT & IIRR 2008). In this quest, the

Participatory Market Chain Approach (PMCA), a structured method that focuses on bringing diverse market-chain actors together to stimulate commercial, technological and institutional innovations (Bernet *et al* 2005, 2008) was introduced in Uganda in 2005 (Horton *et al* 2010). PMCA was applied to the potato, sweet potato and vegetable chains with reasonable success. This paper examines the results of applying PMCA in Uganda over the past seven years.

Materials and methods

In keeping with the participatory nature of PMCA, the study was designed and conducted as action research. It draws on a number of information sources, including project documents, key-informant interviews, participatory review workshop reports and direct observations. During this follow-up study in 2011, the authors visited marketplaces and interviewed 18 market-chain actors, PMCA facilitators and other stakeholders to obtain information on:

- Activities carried out by facilitators, market-chain actors and others to develop innovations or promote the development of market chains;
- Results achieved, with particular attention to changes in knowledge, attitudes and skills; commercial, technological and institutional innovations; inclusion, empowerment and wellbeing; institutionalisation of PMCA; and prospects for the future;
- Lessons learnt that could improve future applications of the approach.

Main results

The PMCA exercise generated a number of results, including new knowledge, skills, social networks, capacity to innovate and rounds of innovation that continue until today.

Commercial, technological and institutional innovations

PMCA focuses on generating commercial innovations, which trigger technological and institutional innovations. Some of the innovations that were developed in 2007 are still in use; some have evolved, while others are no longer on the market (Table 1).

Changes in knowledge, attitudes and skills

According to involved stakeholders, the most important and valued outcomes were the interactions and networks that evolved and have been sustained by the actors. These networks have proven to be very valuable, especially in terms of business strategy development, information sharing and learning. Rapid market-research tools have been found to be highly relevant in the actors' businesses. The PMCA facilitators have become skilled "innovation brokers" i.e. in demand articulation, network formation and managing innovation processes.

Inclusion, empowerment and wellbeing

An important lesson was the difficulty to engage smallholder farmers in joint innovation processes, partly because of their geographic dispersion in rural areas, education levels and resource constraints as compared to other chain actors. Also, because the central goal of the PMCA is to generate innovations in the market chain, not in production systems, market agents tended to participate more actively in the PMCA. Nonetheless, the smallholder farmers that participated reaped significant benefits, including access to and participation in larger markets. Their participation in PMCA exposed them to institutional buyers and, with support from the PMCA facilitators and other chain supporters, they were able to accomplish several transactions, boosting their business and income. This has enabled some of the women to increase the acreage under sweetpotato by 40% or more. Many women acquired household assets and now make significant contributions to their families' incomes. For most, the ability to contribute towards their children's scholastic needs is a source of pride, as they value the importance of educating the children. As a result, the women attested that improved income has resulted in increased harmony in the household, and their contribution towards the family's wellbeing is valued more than ever before.

Table 1: Status of innovations stimulated by PMCA, 2007 and 2011

Innovation	Type	Status in 2007	Status in 2011
Potato group			
Improved packaging and branding of potato crisps for high-end market (TomCris)	Commercial	In local market	In local and export markets
Sealing machine for packaging (TomCris)	Technological	In use	In use
Contractual arrangements between Tomcris and farmer group	Institutional	Being introduced	Worked for some time, currently not functional
Sorting and grading of potatoes for crisp production (TomCris)	Technological	Being introduced	In use
Sweetpotato group			
New orange-fleshed sweetpotato crisps (TomCris)	Commercial	In market	Not in market
New variety (Naspot1) marketed in Uchumi supermarket and exported	Commercial	In market	In market, volumes sold increasing
Marketing concept for composite flour with OFSP: 2 brands (SOSPPA and Kasawo)	Commercial	Being introduced	SOSSPA in market, Kasawo not in production
Improved package for Kasawo OFSP composite flour	Commercial	In use	Not in use except occasionally in shows
Improved package for SOSPPA composite flour	Commercial	In use	In market
Marketing stall/kiosk for selling clean, sorted and graded sweetpotatoes in Kalerwe market	Commercial	Introduced in Kalerwe	Moved to Matugga, in use
Sweet Potato Market Chain Club for all market segments	Institutional	Formative stage	Did not take off beyond club status(nonfunctional)
Vegetable group			
Contract farming of hot pepper	Institutional	In use	In use
Tomato sauce	Commercial	Prototype	Not in market
Tomato chilli appetiser	Commercial	Prototype	In market
Hot pepper paste	Commercial	Prototype	In market
Pickled hot peppers	Commercial	Prototype	Not in market
Sliced and dried hot pepper	Commercial	Not yet in existence	New, exported

Institutionalising the use of PMCA

PMCA core team members have used various approaches to promote use of the PMCA, including development of concept notes, funding proposals, conducting trainings, facilitating PMCA processes and supporting market-chain actors in various ways.

The PMCA has been institutionalised in the Mukono Zonal Agricultural Research and Development Institute (MUZARDI), which used the PMCA to implement two market development projects: in pineapple and indigenous vegetables. Other organisations that have used the PMCA include Participatory Ecological Land Use Management (PELUM) Uganda and Kenya, Food and Agricultural Organization (FAO), Africa 2000 Network–Uganda and the Royal Tropical Institute (KIT).

Key challenges

- Obtaining funding for PMCA applications by research and development actors can be challenging, leading to partial application of the approach or a loss of momentum. This can impact negatively on social relations that are necessary to develop trust among partners, which is a prerequisite for joint innovation. Where donor funding is scarce, future applications could benefit from alternative funding approaches, such as linking up with social investors.

- Translation of ideas across cultural divides and mediation of different interests and points of view among the chain actors required skilled facilitation. Facilitators had to have a “service attitude” to promote cohesion among the thematic group members.
- Many innovators felt that PMCA ended too soon, especially for the consolidation of institutional innovations, which needed time to become well established.
- Upscaling the PMCA required support from previous facilitators. New facilitators would often find the process abstract and “boring”; hence, many opted out.

Key lessons and recommendations for research, policy and practice

Emerging lessons include need to: i) support business development of launched innovations after completing PMCA, to increase chances for business viability, e.g. linking entrepreneurs to financial institutions, Bureau of Standards to obtain quality marks, among others; ii) support farmers to align production to demand, e.g. through staggered production and collective marketing; iii) support innovation brokers, e.g. process facilitators to strengthen skills and develop a community of practice; and iv) set up a “seed” fund to support emerging innovations. Future applications would benefit from a more engendered focus, as this would improve access to and control of benefits among both women and men market-chain actors.

Conclusions

Despite the many challenges faced, the PMCA was successfully applied in Uganda. This could be in part attributed to the commitment by the coordinators, facilitators and interested stakeholders who refused to give up even in the face of funding constraints. The facilitators, in particular, exhibited a “service attitude” and a desire to see the results of the process, to the extent that they have continuously supported the actors whenever and wherever possible, long after the PMCA process formally ended. Among the market-chain actors, the ability to innovate and change their products in line with changing market conditions warrants special mention. The market actors contacted for this study emphasise that such skills are invaluable, as innovations are constantly needed if one is to survive in the market. For the R&D institutions that have continued to experiment and work with the PMCA, studies have been initiated that should help to refine and adapt the approach to local contexts. A cadre of facilitators is slowly building up in these institutions, supported by the initial PMCA facilitators, who are now viewed as “experts”. In this way, capacity is being developed to expand the application of the PMCA within Uganda and elsewhere in the region. In the quest for sustainable rural development, we believe the PMCA can play an important role in the development of value chains for the betterment of smallholder farmers’ livelihoods in Uganda and elsewhere in East Africa.

References

- Bernet T, Thiele G & Zschocke T. 2006. *Participatory Market Chain Approach (PMCA) user guide*. Lima: International Potato Center (CIP).
- Bernet T, Devaux A, Thiele G, López G, Velasco C, Manrique K & Ordinola M. 2008. The participatory market chain approach: stimulating pro-poor market-chain innovation. ILAC Brief 21. Rome: The International Learning and Change (ILAC) Initiative of the CGIAR.
- Horton D, Akello B, Aliguma L, Bernet T, Devaux A, Lemaga B, Magala D, Mayanja S, Sekitto I, Thiele G & Velasco C. 2010. Developing capacity for agricultural market chain innovation: experience with the PMCA in Uganda. *Journal of International Development* 22: 367–389.
- Juma, C. 2011. *The new harvest*. Oxford: Oxford University Press.
- KIT & IIRR. 2008. *Trading up: building cooperation between farmers and traders in Africa*. Amsterdam: Royal Tropical Institute / Nairobi: International Institute of Rural Reconstruction.
- Uganda Bureau of Statistics. 2009, 2010. Key economic indicators. Kampala, Uganda.

Syprobio: Farmer-led innovation platforms to address food security, poverty alleviation and resilience to climate change in West African cotton-growing communities

Gian Nicolay^{1*}, Rémy Dabire², Andreas Fliessbach¹, Laurent Glin² and Fagaye Sissoko³

¹ FiBL (Research Institute for Organic Agriculture) Switzerland, Frick, Switzerland

² FiBL West Africa/IER-CRRA (Institut d'Economie Rurale-Centre Regional de la Recherche Agricole)

³ IER-CRRA/ FiBL West Africa

* Corresponding author. Email: gian.nicolay@fibl.org

Abstract

The social problem of food insecurity and the challenge for farmers in adapting successfully to climate change in West African societies build the framework and scope of our research for development (R4D). It is addressed through a project called Syprobio, operating in Mali, Burkina Faso and Benin. Elected farmers, representing 2000–3000 organic farmers, are conducting on-farm research and cooperating with 40–50 researchers and technicians in testing 27 innovative practices by forming innovation platforms. Soil fertility, seed improvement, pest management, agronomy and socio-economics are the main themes. The innovations being tested are meant to improve food security and climate change adaptation. The main R4D methods used are transdisciplinarity, actor-network theory (Latour 2005), focus-group discussions and decentralised action-research hubs. The innovation, the testing farmers and the researcher build an actor network. After two years, all ten circles of concerted actors (CAC) are productive and, in 2013, they started the second round of testing their selected innovations. The main concern of the farmers is the low soil fertility. Both farmers and researchers learn mutually, as well as the technicians from the farmer organisations. The creativity, determination and curiosity of the self-organised farmer groups, embedded in a supportive research network and exciting value chains, allow fast and effective identification of innovations to be tested and implemented. It is recommended to further invest in better alignment at national level of farmer needs, research methods of national agricultural research institutes and universities, and policies in order to create functional institutions.

Keywords: *farmer-driven research, transdisciplinary research, decentralised processes, organic cotton systems, West Africa*

Introduction

The current social, economic, climatic and ecological situation in West Africa offers both practical and intellectual challenges. Agriculture and food systems are at the heart of this “multidimensional complex” (ECOWAS 2008). Soil degradation, pests, hunger, uncertainties about the changing climate, rural-urban cleavages, civic unrest and wars as well as resource-poor states and fragile societal structures provide a dangerous mix for social stability and peace in the region. Organic agriculture is growing in Africa, and is seen by its proponents as an appropriate way to address food security, land conservation, poverty and adaptation to climate change (IAASTD 2009, Bouagnimbeck 2013, Nicolay 2012, Scialabba & Müller-Lindenlauf 2010). From 50,000 ha in 2000, it increased to more than one million ha in 2010.

Cotton is one of the most important cash crops providing rural income in the sub-Saharan savanna. Cotton farmers are always cereal farmers, and often among the most productive, as they have better access to inputs through their close market and industry links. Organic cotton is produced by roughly 18,000 smallholder farmers in the subregion. The organic producers

use the same non-genetically modified (GM) seed varieties as the conventional farmers but make use of locally produced compost and biopesticides as inputs. Numerous pests attack cotton, making pest management an important and demanding activity. Producing sufficient compost is laborious (problems of water and small equipment) and the biopesticides, because instable, have to be applied frequently (up to 7 applications in Mali) as they often have a contact or repellent property that can be washed off the plant surface. The introduction of GM cotton varieties in Burkina Faso in 2008 is a growing risk for organic producers, as their premium price will be lost in case of contamination with GM cotton (which happened twice in the last four years in Burkina Faso, where 10% of the organic cotton had to be declassified). Soil fertility is another major issue for organic producers, because knowledge is often lacking in producing the required organic matter, even if nutrients are made available by the active soil microflora. The loss of soil organic matter has reduced the stability of soils towards erosion that often occurs after heavy rainfall and increases the risk of losing the most fertile topsoils. Cotton production is a highly political issue with contested policies worldwide. The price fluctuations of this global commodity are particularly great in West Africa, as this subregion exports most of the cotton lint, mainly to China.

The need for a new research paradigm and the introduction of innovation platforms

The high demand for organic and fair-traded cotton cannot be met by supply (Pay 2009). The complexity of this commodity – high requirements on the soil, pests, price fluctuations, political interference, pressures from input suppliers and importers, strategic role of the ginning industry, GMO threat, competition with newly emerging cash crops (mainly from horticulture, cowpeas and sesame), policy tradeoffs – requires new ways of agricultural research. Concerted action bringing together the stakeholders is an indispensable requirement for structural and technological change and is being tested within the EuropeAid-funded Syprobio project (2011–15).

This project is based on the existing organic cotton value chain developed by Helvetas since 1999 and reinforced by national – Institut d'Économie Rurale (IER) in Mali, Institut de l'Environnement et des Recherches Agricoles (INERA) in Burkina Faso and Institut National de Recherche Agronomique du Bénin (INRAB) in Benin – and international (FiBL) research organisations. These actors, centred on the locally organised researcher-farmers, constitute innovation platforms to promote appropriate technologies favouring the livelihoods of family farmers and increasing their resilience. An innovation platform (IP) is defined here as a social system with the purpose of solving its members' problems through concrete and systematic communication in order to produce or construct desired innovation. The platform regards innovation as a systemic and dynamic institutional or social learning process and recognises that it can emerge from many sources (science or indigenous knowledge or elsewhere), complex interactions and knowledge flows. IPs are also seen as a practical tool to find solutions in an effective, nation-wide and sustainable way (Adekunle & Fatunbi 2012).

In the Syprobio project, the IPs are composed on average of ten organic farmers from the neighbourhood, three technicians/extensionists and two researchers. The complexity and multidimensional character of the issues of food insecurity and climate change adaptation (CCA) in West Africa inspired the framework and scope of our research for development. The objective of this project is to produce practical and scientifically tested technological innovations likely to improve soil fertility, crop diversity, yield stability and food security in a context of climate change. The project is testing the following core hypotheses:

- Relevant technologies for small-scale farmers leading to food security and CCA for both organic and conventional farmers can be invented and implemented by farmer associations designed specifically for that purpose;
- Soil organic matter (SOM) is required for soil stability and fertility to attain resilient and sustainable yields; organic farmers have advantages in reaching sufficient SOM levels;

- Innovations invented and tested jointly by farmers and researchers are more likely to be adopted than those invented and tested solely by farmers or solely by researchers;
- Adoption of jointly developed technological innovations will result in more robust agricultural and food systems that will improve food security and can contribute to economic integration and nation building.

Research methods

We used a series of methods and concepts including theorising, transdisciplinarity, actor-network theory (Latour 2005), focus-group discussions, decentralised action research and systems theory (Luhmann 1995). The discipline of sociology was chosen to guide the research itinerary and its semantics and to stimulate creative research ideas driven by observation and by empirical data in order to stimulate discovery (Swedberg 2012). We produced a heuristic “theory of Syprobio” in the form of a visualised system of the interconnected biophysical and sociological factors that determine the ideal cotton-based agriculture system in the context of climate change (Figure 1).

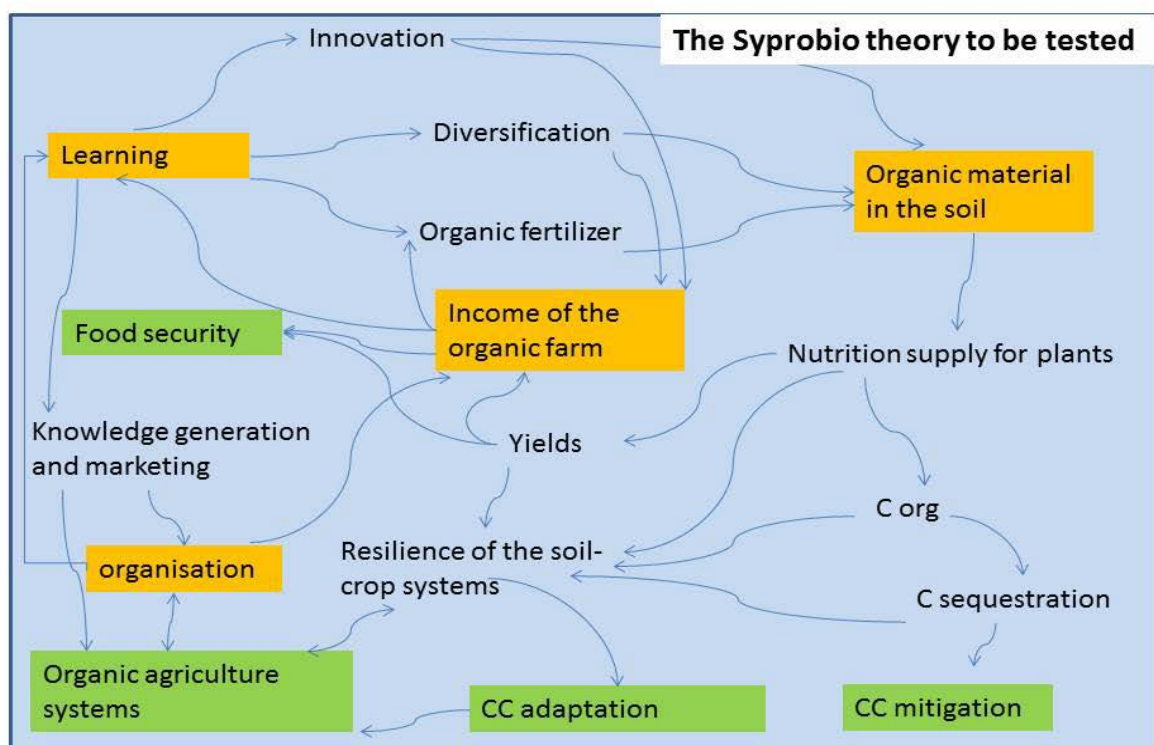

Figure 1: The Syprobio theory as a heuristic tool at the early stage of the research-for development itinerary

Decentralised hubs were created – ten circles of concerted actors (CACs: *Cercles des acteurs concertés*) and three national Syprobio networks – which are evolving into innovation networks. The innovation, the testing farmers and the researcher form an actor network. In each country, a farmer organisation (FO), a research institution and the local office of Helvetas are partners in the project coordinated by FiBL Switzerland and its local office FiBL West Africa in Sikasso, Mali. In a first step, CACs of ten farmers each were formed in ten subregions ranging from southern Mali and southern Burkina Faso to northwest Benin (Figure 2).

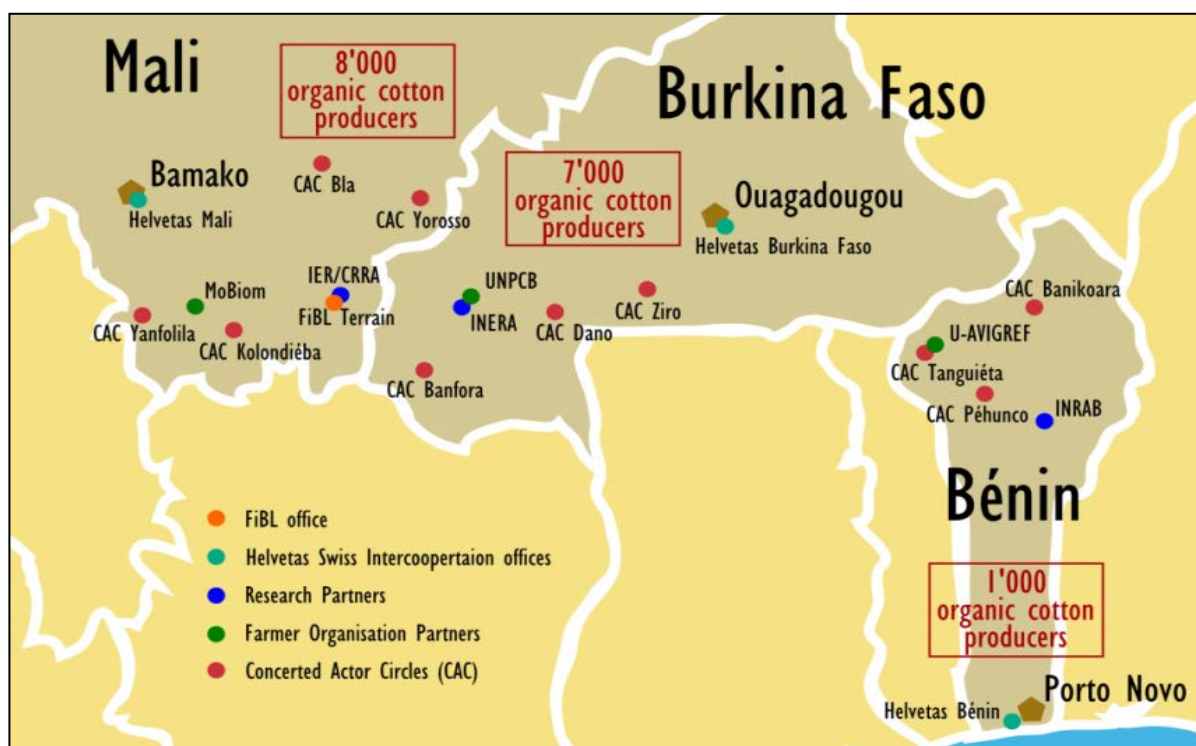

Figure 2: Distribution of the main actors in the innovation network of cotton farmers, farmer organisations and research institutions

They defined their constraints and questions to be solved, leading to a list of 166 questions and problems. Through a series of multistakeholder roundtables, the researchers and advisors sorted the list and came up with 27 topics to be tested in farmers' fields. The farmers of each CAC, representing 600–2000 organic farmers each by mandate, were then asked to conduct on-farm research in close collaboration with 30–40 researchers and advisors in the three countries. Soil fertility, seed improvement, pest management, agronomy and socio-economics are the main research themes of the organic cotton-cereal farmers. The innovations being tested should improve food security and CCA.

Results after two years

All ten CACs are working well as IPs and actor networks. Innovations tested in 2012 are currently (2013) being repeated in a second round. Two innovations related to seeds are already conclusive and will go for upscaling. The main technical concern of the farmers is still the low soil fertility and the technical and socio-economic constraints in overcoming it. Apart from the eight innovations to be tested within the project scope (Table 1), on-station trials, literature search and cooperation with like-minded networks and organisations are done. From the nontechnical side, the bleak situation related to credit outside the conventional and GM cotton value chain as well the poor rural advisory services are major concerns. Many farmers cannot work their land because they lack draught animals or cannot buy the inputs they need to optimise their farm operations. Both farmers and researchers learn mutually, as well as the technicians from the FOs. This learning has to be transformed into actions of systemic change. On-station experiments have been launched in the three countries to address some specific issues (e.g. assessing the risk of cohabitation with GM cotton). One of the most remarkable impacts so far is the farmers' increased trust in research and the new self-confidence in self-organised processes. It is to be seen how this momentum can be transformed into larger social change within the rural cotton communities.

Table 1: Number of innovations tested in the different domains as defined by farmers, advisors and researchers in the three countries

Country	Soil fertility	Seed	Plant health	Cultivation	Socio-economic	Total
Mali	2	3	1	2	1	9
Burkina Faso	2	2	2	1	2	9
Benin	4	-	2	2	1	9
<i>Total</i>	8	5	5	5	4	27

Source: Project Syprobio (2012)

Lessons learnt, challenges and recommendations

The creativity, determination and curiosity of the self-organised farmer groups, embedded in a supportive research network and existing value chains, allow fast identification of innovations to be tested and applied. Local resources (biological agents, social capital, experiences) are used and experimented on field and village level. The main challenges are in communication, cost reduction for field visits by researchers, and institutional stability and durability (research, FOs, markets). The participatory approach that is at the centre of our research method and materialised through the IPs enables interactive and social learning among the involved stakeholders. Farmers’ capacities to analyse and make decisions are improved. It is recommended to further invest in better alignment at national level of farmer needs, research methods of national agricultural research and universities, and policies in order to create functional institutions. Social systems theory can be used more to improve the understanding of the required systems: i) politics within the nation-state, including the Economic Community of West African States (ECOWAS) subregion; ii) economy with the subsystem “food and agriculture”; and iii) science of agriculture and rural development as part of the science system.

The food and agriculture system is part of the economy but also has implications in society and ecology. A new way of perceiving this system “as a system” through transdisciplinary approaches can lead to more balanced solutions than in the past. Agricultural science is distinct from economy, society and politics through its own purposes and language. Good communication between these three systems – science, economy and politics – will be required to successfully scale up the promising innovations and make them fruitful for the two million cotton farmers in West Africa. The concept of “greening the economy with agriculture” (FAO 2012) provides a framework aligning local to global patterns of action. The subregional agricultural policy (ECOWAS 2008) allows new and more efficient interventions than just isolated national policies and programmes. More effort is required to grasp the immense potential for economy, society and biodiversity by assisting small-scale farmers in using their inherent potentials and developing the rural space and, with it, the urban space.

We believe that ways to further develop organic and related forms of sustainable agriculture and food systems as hyper-modern (because of its potential to optimise the various trade-offs of world society and overcome some of its major well-known weaknesses) in dealing with multifunctional challenges will prove beneficiary for West Africa as it did for Europe so far. Healthy people and watertables, reduced pollution by herbicides, increased biodiversity and low economic risks for the farm “enterprises” are universal values. Organic food and agriculture are still in the making and will be accelerated through appropriate laws, policies, and economic, scientific and societal operations. It is noteworthy that the ecologically and economically leading European societies have fast-growing organic industries and systems, driven by the demand of consumers and citizens. The creativity, determination and curiosity of the self-organised farmer groups, supported by research and extension, lead to effective

innovation based on local resources. The groups have the potential to stimulate the larger cotton communities and to fertilise new emerging IPs. Policy as well as the economy can be informed and reshaped if the stakeholders of the IPs, supported by sound scientific practice, function well. The enduring solidarity at global level and the needed financial support for such operations is, of course, still required.

References

- Adekunle AA & Fatunbi AO. 2012. Approaches for setting up multi-stakeholder platforms for agricultural research and development. *World Applied Sciences Journal* 16 (7): 981–988.
- Bouagnimbeck H. 2013. Latest developments in organic farming in Africa. In: *The world of organic agriculture: statistics and emerging trends*. FiBL-IFOAM Report. [Online].
- ECOWAS. 2008. *Regional Agricultural Policy for West Africa. ECOWAP. Make agriculture the lever of regional integration*. ECOWAS Commission.
- FAO. 2012. *Greening the economy with agriculture*. Rome: FAO.
- IAASTD. 2009. *Agriculture at a crossroads: international assessment of agricultural knowledge, science and technology for development: global report*. Washington DC: IAASTD.
- Latour B. 2005. *Reassembling the social: an introduction to actor-network theory*. Oxford: Oxford University Press.
- Luhmann N. 1995. *Social systems*. Stanford University Press.
- Nicolay GL & Baker B. 2012. Challenges and opportunities for organic research and extension. *Rural* 21 (03/2012): 32–34.
- Pay E. 2009. *The market for organic and fair-trade cotton fibre and cotton fibre products*. Rome: FAO.
- Scialabba NE-H & Müller-Lindenlauf M. 2010. Organic agriculture and climate change. *Renewable Agriculture and Food Systems* 25: 158–169.
- Swedberg R. 2012. Theorizing in sociology and social science: turning to the context of discovery. *Theory and Society* 41: 1–40.
- UNCTAD (ed.). 2008. *Organic agriculture and food security in Africa*. New York & Geneva: United Nations.
- Willer H, Lernoud J & Home R. 2013. *The world of organic agriculture: statistics and emerging trends*. Frick: Research Institute for Organic Agriculture (FiBL) / Bonn: International Federation of Organic Agriculture Movements (IFOAM).

The role of multistakeholder platform processes in promoting innovation in rice-based systems in West Africa

Cara M. Raboanarielina^{1*}, Abdoulaye Kaboré¹, M'Piè Bengaly², Francois Dossouhoui³ and Christophe Kinha⁴

¹ Africa Rice Center (AfricaRice), Cotonou, Benin

² Institut d'Économie Rurale (IER), Sikasso, Mali

³ International Centre for development oriented Research in Agriculture (ICRA) Accra, Ghana

⁴ Fédération des unions de producteurs du Bénin (FUPRO), Bohicon, Benin

* Corresponding author. Email: c.raboanarielina@cgiar.org

Abstract

Multistakeholder platforms (MSPs) have been promoted as a way to facilitate collaborative and innovative learning and decision-making in agricultural systems. The “Realizing the Agricultural Potential of inland valley lowlands while maintaining their environmental services” (RAP) project was established to promote sustainable diversification and intensification of agricultural productivity and value-chain development using an MSP approach. This research examines how MSPs, by promoting collaborative partnership building and interaction among stakeholders, fostered innovation in two inland valley rice-based systems in Benin and Mali. Facilitated group discussions with MSP actors in both countries were conducted to understand how the establishment of and participation in the multistakeholder processes fostered innovation.

MSP participants reported that they better understood others' needs and production objectives and felt greater social cohesion with others with whom they had not worked previously. In Benin, actors described increased technical capacity in rice cultivation, processing and wholesaling to improve collective market access. In Mali, actors noted similar benefits related to collective management of local production systems, yet their experiences focused more on innovations in governance and resource management. The multistakeholder process was not without its challenges. Initial unfamiliarity with the approach was a challenge in sustaining participant motivation. In Mali, researcher facilitators reported that the time investment to coach and facilitate MSPs was demanding. In Benin, the private sector was mostly absent, which limited financial support services to promote more profitable exchanges among value-chain actors. In both countries, resource mobilisation to support the MSPs was an issue.

Implications of this research suggest that social-learning innovations in inland valley systems are just as important as technical innovations to improve rice-based systems, as they enhance the institutional capacity of inland-valley actors to collectively affect change and improve local production systems. However, multi-actor approaches should encourage involvement of certain actors in certain phases to ensure effective participation, actor motivation and collective benefit.

Keywords: *multistakeholder processes, social learning, rice-based systems, inland valleys, West Africa*

Introduction

In West Africa, there are an estimated 20 million ha of underutilised cultivatable inland valley lowlands (Windmeijer & Andriessse 1993). While only 10–25% of these inland valleys are being used for agricultural production, maintaining ecosystem services in a sustained manner while promoting intensification of inland valleys is a concern (*ibid*). Increasing

population, climatic change and limited arable land led communities to exploit inland valleys. These lowlands offer opportunities for diversification such as vegetable production and aquaculture within rice-based systems. This creates new market opportunities and improves the livelihoods of inland-valley resource users.

The RAP¹⁵ project was established to promote sustainable diversification and intensification of agricultural productivity and value-chain development in selected inland valleys using a multistakeholder platform (MSP)¹⁶ approach. Challenges and dynamics in inland valley lowlands are diverse and complex. They call for integrated, concerted action by a wide range of institutions and stakeholders to collectively identify, develop and improve options for sustainable production, processing and marketing of agricultural products. This research examines how MSPs, by promoting collaborative partnership building and interaction among stakeholders, fostered innovation in two inland valley rice-based systems in Benin and Mali. Here, innovation refers to the *process* of interaction between individuals, institutions and actors working together to develop new products, knowledge, or technologies to improve economic outcomes (Hall *et al* 2006).

Materials and methods

Four inland valley sites (two in Benin and two in Mali) were selected by the RAP project using several criteria. These included the agricultural potential for rice production, opportunities for crop diversification, variability of biophysical and socio-economic conditions related to climate and land and water access, and a significant presence of other actors (beyond AfricaRice and the national agricultural research system partners) and development institutions working within the inland valley. In 2009, two MSPs were established in southern Mali (Doumanaba and Bamadougou in the Sikasso Circle) and two in southern Benin (in Houéyogbé Commune, Mono Department, and in Dogbo Commune, Couffo Department). They were established in order to promote value-chain development in rice-based systems in the inland valley. The key crops in the valleys in Mali were potato, rice, maize and sweetpotato and in Benin rice, maize, tomatoes and leafy greens. Also, the MSPs were to be at the centre of project implementation, as the platforms were meant to serve as venues to discuss and evaluate research outcomes from the project.

Together with international and national partners, we applied a participatory, dynamic facilitation approach to set up MSPs, modified from Tennyson *et al* (2009:3) (Figure 1). This 12-stage process emphasised collaborative, collective learning and reflection by a range of inland-valley actors. The multi-actor approach aimed to collectively identify key issues, problems and constraints and to develop a purposive action plan by bringing different groups of resource users together who had not previously collaborated, to encourage joint action and decision-making around rice-based production systems and the value chain. Facilitated group discussions were conducted through a series of three workshops in 2011 and 2013 to evaluate the MSP process and outcome. MSP actors reported on how participation in the multistakeholder process fostered innovation and joint learning in rice-based production systems within the inland valley.

¹⁵ RAP: “Realizing the Agricultural Potential of inland valley lowlands while maintaining their environmental services” EU-funded project for the period 2009–13 in Benin, Mali, Sierra Leone and Liberia, coordinated by AfricaRice in collaboration with international (CIRAD, ICRA, WUR, CDI) and national (INRAB, UAC IER) partners.

¹⁶ MSPs describe both the interaction and the process to promote democratic principles of transparency and participation to develop partnerships and strengthen networks among various actors engaging in joint action within an agricultural commodity value chain (Hemmati 2002, Thiele *et al* 2011).



Figure 1: Multi-stakeholder Platform establishment process (adapted from Tennyson *et al* 2009)

Main results

In 2011, over 40 individuals were members of the MSPs in Mali; in Benin, there were over 200 members in both MSPs. The great difference in number of members is due to the Malian MSPs' interpretation of MSP membership. The inland valley areas in Mali are much larger (Doumanaba inland valley area = 1426 ha; Bamadougou inland valley area = 752 ha) than in Benin (Dogbo inland valley area = 33 ha; Houinga-Houéyogbé inland valley area = 32 ha). Because the inland valleys in Mali cover such a vast area, the MSP decided during the inception phase that platform members would represent various resource users' and other actors' associations/groups present in the valley; thus, the number of members within one MSP may appear to be low but it actually represents the views of hundreds of individuals. MSP members in both countries included various actors along the value chain (Table 1).

Overall, as a result of the multi-actor process, participants reported that they better understood each other's needs and production objectives and felt greater social cohesion with others with whom they had not previously worked. Prior to the MSP, farmers, pastoralists, fishers and aggregators had their own associations that focused on addressing the specific resource-users' needs and there was little or no communication between or coordination across these groups to address collective resource management of the inland valley. Actors stated that taking part in the MSP improved institutional linkages, trust and collaboration among different resource-user groups. During MSP facilitation, actors were able to map out

and discuss interrelations between resource-user groups in the inland valley and how one group's actions affected collective resource availability and use and, hence, impacted on other groups. This rebuilt the social fabric connecting different groups and helped resolve conflicts surrounding natural resource management such as canal maintenance, irrigation methods and livestock grazing. Also, the active involvement of local government representatives within the platform helped increase visibility of the MSP action plan at regional level, resulting in public support for certain social infrastructure improvements. In addition, stakeholders reported they had gained an increased technical knowledge and capacity in rice cultivation, processing and wholesaling.

Table 1: MSP composition, representation and major cultivation

	Sikasso Circle (Mali)	Mono and Couffo Departments (Bénin)
MSP members	Doumanaba (20) Bamadougou (21)	Dogbo (118) Houéyogbé (126)
Actors represented	Farmers Pastoralists Fishers Processors Input suppliers Traders Extension services NGOs Local government Landowners	Farmers Pastoralists Fishers Processors Input suppliers Traders Extension services NGOs Local government Landowners Microfinance institutions
Major crops	Rice, maize, potato, sweetpotato	Rice, maize, leafy greens, tomato

In terms of social learning, the MSP process raised awareness about the role and significance of multi-actor processes in participatory action research (PAR), especially for the national researchers working in the RAP project. Selected researchers within the national agricultural research institutes were initially skeptical about the importance and effectiveness of PAR to initiate on-the-ground change within the inland valleys. Through their participation, they gained knowledge and a new appreciation about the value of multi-actor processes and role they play in PAR as well as in agricultural research for development. The significance of this change broadened researchers' view of stakeholders and inland-valley actors as active partners and decision-makers and not just "participants" in research and stimulated them to work towards institutional change to promote technical and productivity enhancement in the inland valleys.

While numerous outcomes from the multistakeholder process were similar across the countries, there were differences specific to the local context. In Benin, MSP members stated that they had better access to improved rice seed and received technical training on numerous agricultural topics such as improved rice parboiling and processing techniques and improved techniques of integrated pest management (IPM). They also noted innovations related to production practices, which – according to them – increased their overall rice production and yields. As a result of their MSP involvement, they organised themselves to form a collective to manage bird scaring, negotiate access to thresher and milling equipment, and negotiate prices for selling paddy. In addition, MSP members felt overall that the innovation focused more on improving the collective capacity of actors to initiate joint action. In Houéyogbé, MSP members were able to organise themselves to request European Union funding for a grain storehouse. They noted that this strengthened their capacities, gave them the confidence

to negotiate land-tenure issues within the inland valley and encouraged individual members to take part in literacy programmes.

In Mali, MSP members noted similar benefits related to collective management of local production systems, yet their experiences focused more on innovations in governance and resource management. As in Benin, they described the technical innovations resulting from the multi-actor process, including the organisation of a women's rice-parboiling business, access to improved potato seed, improved IPM techniques and the introduction of new commodities such as onions to inland-valley production systems. However, the most notable innovation was improved institutional capacity of the platform, allowing it to raise the visibility of the inland-valley issues at regional level and resolves conflicts. In Doumanaba, the MSP action plan allowed MSP members to advocate for the building of a bridge in the commune to improve market access. The mayor of the Doumanaba commune was an active member of the platform; with his political position and power, he was able to take the MSP action plan as template for infrastructure development to include in the 5-year community plan. In addition, the MSP process in Mali helped resolve conflicts between pastoralists and potato farmers over trampling of fields by grazing cattle. Another conflict was resolved between rice and vegetable farmers, as women farmers encouraged the use of waterpumps instead of artisanal wells to improve safety during irrigation.

Key challenges

While the multistakeholder process led to many positive innovations, several key challenges were noted in both countries. Initial unfamiliarity with the approach was a challenge in sustaining participant motivation. The entire facilitation process for the MSPs in both countries continued over the course of 18 months; it took time for actors to understand the process and embrace it. At first, confusion about the difference between a farmer/resource-user association and an MSP was an issue. Members and even national researchers were initially skeptical about the value of the latter in actually improving inland-valley production systems, knowledge and the value-chain process. In Mali, researcher facilitators reported that the time investment to coach and facilitate MSPs was too demanding, as they had other time-conflicting responsibilities within their institutions. Another challenge specific to Benin was the absence of the private sector in the platform, which limited financial support services to promote more profitable exchanges among value-chain actors.

In both countries, local financial support by stakeholders to support the MSPs after the end of RAP project funding was an issue. This challenge perhaps indicates that our approach was too focused on “parachuting in” rather than creating a platform embedded more in the local social context to ensure sustainability based on existing structures. While actors in all MSPs reportedly paid financial dues/contributions to the platform, they were unsure of the sustainability of this system. Actors often voiced their concern that they needed additional funding from outside organisations, whether NGOs or other donors, to support the MSP in the long term.

Key lessons and recommendations

To be fully functional at value-chain level, it is important to have broad representation in the MSP membership, especially private-sector actors (traders, creditors etc). Their participation should be encouraged at different stages in order to ensure effective actor engagement and to improve actor motivation, benefits and overall group effectiveness. Facilitation is very crucial at the beginning of the process to ensure better interaction and sustained commitment to the multi-actor process. However, it should be gradually handed over to existing structures on the ground (organisations already leading multi-actor processes such as NGOs, businesses etc) to ensure sustainability of the MSP. We believe facilitation should not be handled by researchers but rather by other, locally embedded institutions. Such institutions that have

long-term presence in the area can ensure continuity and sustainability of the platform once research projects are completed; thus, it makes sense for them to lead the facilitation and coaching. Researchers can develop the approach and tools for the multi-actor process but should seek external organisations to lead the facilitation process. We see this as a key recommendation to help ensure continuous upscaling and outscaling of the multi-actor processes. Mobilising the funds needed to sustain the MSP should be carefully addressed at the beginning of the facilitation process on a cost-sharing basis among all MSP actors. This will help improve financial sustainability of the platform over the long term. Finally, the co-creation of the vision of the MSP, its goals, operational plan and action plan are necessary for the platform to succeed. The participatory approach integrating multiple actors at local and regional level enabled platforms to extend their action plans beyond the inland valley to address needs at the community and broader level.

Conclusions

This research suggests that social-learning innovations are just as important as technical innovations to improve rice-based systems, as they enhance the institutional collective capacity of actors to bring about change and to improve local production systems. Many of the outcomes of the MSP experiences in both Benin and Mali included technical innovations such as improvements in production, processing and wholesaling. However, actors in both countries noted institutional innovations related to collective decision-making for resource management in the inland valleys (i.e. conflict resolution among users, using waterpumps instead of wells to improve safety, and group organisation to promote social infrastructure such as bridges and grain-storage facilities). This engagement in joint action improved the collective capacity of the actors and their self-confidence as a group to work together to promote value-chain development and improve resource management in the inland valleys.

References

- Hall A, Janssen W, Pehu E & Rajalhati R. 2006. *Enhancing agricultural innovation: how to go beyond the strengthening of research systems*. Washington DC: World Bank.
- Hawkins R, Booth R, Chitsike C, Twinamasiko E, Tenywa M, Karanja G & Verschoor AJ. 2009. Strengthening inter-institutional capacity for rural innovation: experience from Uganda, Kenya and South Africa. In: Sanginga P, Waters-Bayer A, Kaaria S, Njuki J & Wettasinha C (eds), *Innovation Africa: enriching farmers' livelihoods* (London: Earthscan), pp313–325.
- Hemmati M. 2002. *Multi-stakeholder processes for governance and sustainability: beyond deadlock and conflict*. London: Earthscan.
- Tennyson R, Huq N & Pyres J. 2009. *Partnering step by step*. London: The Partnering Initiative – The International Business Leaders Forum (IBLF).
- Thiele G, Devaux A, Reinoso I, Pico H, Montesdeoca F, Pumisacho M, Andrade-Piedra J, Velasco C, Flores P, Esprella R, Thomann A, Manrique K & Horton D. 2011. Multi-stakeholder platforms for linking small farmers to value chains: evidence from the Andes. *International Journal of Agricultural Sustainability* 9 (3): 423–433.
- Windmeijer PN & Andriess W (eds). 1993. *Inland valleys in West Africa: an agro-ecological characterization of rice-growing environments*. Wageningen: International Institute for Land Reclamation and Improvement.
- Woodhill J. 2010. Multiple actors: capacity lives between multiple stakeholders. In: Ubels J, Acquaye-Baddoo N & Fowler A (eds), *Capacity development in practice* (London: Earthscan), pp25–41.

Enhancing farmers' organisational and experimentation capacities for soil fertility management in smallholder cropping systems in Vhembe District of Limpopo Province in South Africa

Gerrit Rootman^{1*}, Brigid Letty² and Joe Stevens³

¹ Limpopo Department of Agriculture, Towoomba Research Station, Bela Bela, South Africa

² Institute of Natural Resources, Scottsville, South Africa

³ University of Pretoria, Pretoria, South Africa

* Corresponding author: Email: gt.rootman@gmail.com

Abstract

The JOLISAA (JOint Learning in Innovation Systems in African Agriculture) project analysed innovation cases in smallholder agriculture in Benin, Kenya and South Africa through a Collaborative Case Assessment (CCA) process. The overriding assumptions were that a comparative analysis of wide-ranging innovation experiences would provide useful insights into the way that innovation processes are triggered and unfold in smallholder farming systems, and that this knowledge could be applied to inform policy processes. In Limpopo Province of South Africa, project-based innovation processes, which had been initiated to redress apartheid legacies, were analysed for this purpose. Participatory Rural Appraisal methodologies were used to interview smallholder farmers and key informants. It was revealed that the primary innovation process aimed at developing a participatory extension approach to broaden agricultural service and extension delivery to smallholder farmers in a democratic South Africa. The GTZ/BASED programme trained some 700 extensionists in this methodology, capacitating them to facilitate technical innovation among smallholders in one of four technical areas. A total of 400 villages were eventually served. The extensionists specialising in soil fertility management teamed up with a local university to redress a severe decline in soil fertility in two smallholder irrigation schemes. Together with farmers, they experimented with innovative techniques such as green manuring with forage legumes. These technical innovation processes created capacity among smallholders that triggered spontaneous farmer-initiated experimentation and innovation processes to improve smallholder farming systems and livelihoods. The key lesson was that project-initiated innovation could trigger farmer innovation. It is recommended that developmental-change strategies should explore such opportunities. The key challenge identified was that decisive institutional ownership is required to sustain an enabling environment that allows innovation processes to continue beyond the project phase.

Keywords: *innovation, soil fertility, smallholder cropping*

Introduction

The EU-funded JOLISAA (JOint Learning in Innovation Systems in African Agriculture) project assessed a series of smallholder agricultural innovation cases in Benin, Kenya and South Africa. The project objectives that were pursued assumed that a comparative analysis of a diverse range of innovation experiences would provide useful insights into the way innovations are triggered and unfold in smallholder farming systems, and that this knowledge could be applied to inform policy processes. For this purpose, a post-apartheid institutional innovation process to broaden extension service delivery in Limpopo Province of South Africa was analysed. Project-initiated technical innovation processes seeking alternative ways to improve and manage soil fertility in smallholder cropping systems in Vhembe District had been facilitated. The participation of smallholders in on-farm experimentation

built capacity that lead to spontaneous farmer-initiated innovation processes to improve smallholder farming systems, livelihoods and a social innovation to reduce the number of meetings and the time away from their farming enterprises.

Research methods

In South Africa, the first phase of the JOLISAA project produced an inventory of 39 agricultural innovation cases. Specific selection criteria were developed to narrow this down to 11 cases and to finally select the three cases that were assessed through a collaborative process during 2012. The team established for assessing the case selected in Limpopo Province applied Participatory Rural Appraisal (PRA) methodologies to engage smallholder farmers and key informants to capture how innovation processes unfolded to improve soil fertility in cropping systems in two smallholder irrigation schemes in Vhembe District, namely Mphaila and Rammbuda.

The focus of the assessment was on the innovation processes emanating from a partnership between Limpopo Department of Agriculture (LDA) and the German Agency for Technical Cooperation (GTZ) from 1998 to 2005 as a post-apartheid intervention to normalise the agricultural landscape in Limpopo Province through better service delivery to the smallholder sector in the former homelands. This programme, called Broadening Agricultural Service Delivery and Extension, later became widely known as the GTZ/BASED programme.

Main results

The CCA process revealed that the primary innovation process of the GTZ/BASED programme set out to transform the LDA extension service from applying a transfer-of-technology approach, towards applying a farmer-centred approach that focuses extension service delivery to smallholder farmers. Development consultants from Germany and Zimbabwe, LDA staff and smallholder farmers engaged in an action-learning process to develop and institutionalise a participatory extension approach (PEA) as a best-practice model for the provincial extension service.

Facilitation competence to mobilise smallholder communities to better articulate their farming problems and to strengthen local organisational capacities was central to the PEA (Ngwenya *et al* 2009). A core group of PEA trainers was trained. These trainers thereafter trained and mentored some 700 extensionists in PEA methodologies and facilitation skills during a 22-week on-site and in-the-field training course.

A major aim of PEA was to challenge extension staff to shift their paradigm radically in terms of personality and professional attitude. This implied de-learning the top-down transfer-of-technology mode of engaging with farmers, where extensionists are supposed always to have answers to farmers' problems versus assuming the role of a catalyst for social change (Ngwenya *et al* 2009) through learning together for change (Hagmann 1999). At a practical level, the two models differ as follows. Conventionally, extensionists provide technical advice on enhancing production of specific commodities and they hold the knowledge on those commodity packages. This model does not reflect the social dynamics of the society or community, and often only a minority of farmers benefit from these extension services (Ngwenya *et al* 2009). The PEA approach deals with the social dynamics, looking at service functions required in an innovation system based on solving problems in smallholder farming. It focuses on establishing a common platform for trying out new alternatives. It aims at enhancing the adaptive capacity of rural people, enabling them to better manage a changing economic, social and ecological environment and to adapt their practices and the way they are organised (Ngwenya *et al* 2009).

Extension staff trained in PEA could specialise in one of four technical areas: soil fertility management, soil and water conservation, small-scale livestock production and small-scale seed production. The number of villages mobilised by GTZ/BASED to practise the different

technical areas by 2005 were: soil fertility management (105), soil and water conservation (99), small-scale livestock production (98) and small-scale seed production (98).

Participatory exercises in two smallholder irrigation schemes in Vhembe District had identified a severe decline in crop yields resulting from loss of topsoil and soil fertility because of high-intensity rainfall events the previous year. The soil fertility management working group and the University of Venda initiated a project-based technical innovation process to explore alternatives to commercial fertiliser application to restore and manage soil fertility. The participation of smallholder farmers in the on-farm experiments with forage legumes and green manure created the capacity to trigger spontaneous farmer-initiated technical and social innovations. For example, the farmers evaluated the effect of other organic fertilisers such as chicken manure. This overturned the traditional institutions and recommendations by extension staff, who previously discouraged the use of organic fertilisers, and can be viewed as another spontaneous farmer-initiated institutional innovation. Farmers also observed that increased soil organic matter improved the moisture-holding capacity and structure of the soil, allowing opportunities to grow and market green maize cobs during the dormant season, when there is insufficient water for irrigation. They tested different planting dates for maize. This innovation improved household income and smallholder livelihoods.

Further spontaneous farmer-initiated innovation led to a change in the farmer organisational structures to reduce the off-farm time spent attending meetings. Instead of continuing with the original organisational structure that was mobilised by GTZ/BASED, the farmers – through a farmer-initiated social innovation process – disbanded the individual interest groups, each of which had an elected leadership and held individual meetings. They elected a collective leadership to accommodate all the participating farmers in one meeting, where crosscutting issues could be discussed as well as those that are exclusive to a specific group. This innovation works well and is effective to collectively solve farmer challenges.

Key challenges encountered

The PEA approach, developed and implemented by the GTZ/BASED programme, proved that the new methodology and the training provided to extension staff made a breakthrough in terms of the way agricultural extension is delivered to smallholder farmers in a democratic South Africa. The project-based soil fertility improvement and management innovation processes triggered farmer-initiated experimentation and innovation that improved livelihood situations.

Despite these tangible successes, LDA decentralised the provincial extension service, which then effectively ceased the institutional support required to progress beyond the project phase towards farmer ownership, sustainability and continued farmer-initiated innovation processes. Farmers pertinently raised the issue that, after the institutional support ceased, they could not obtain forage legume seed to continue practising green manuring. The key challenge identified was that decisive institutional ownership and support to provide an enabling environment is a prerequisite for farmer-initiated innovation processes to continue beyond the project phase.

Key lessons and recommendations

From the JOLISAA analysis, it is clear that the development and implementation of the PEA approach through the GTZ/BASED programme was a turning point in terms of a best-practice model for future agricultural extension service delivery to smallholder farmers in a democratic South Africa. Extension staff of LDA received purposeful theoretical and practical training to master participatory methodologies. They were allowed to specialise in one of four technical areas. This gave them the confidence and knowledge base to engage with smallholder farmers to help them solve their problems. Through this engagement,

smallholder farmers were capacitated to identify and express their farming problems and needs. The participatory innovation development processes focused on solving these problems through on-farm trials. The green-manuring technology was a viable alternative to address soil fertility run-down and effectively addressed farmers' problems, but the lack of continued institutional support (enabling environment), e.g. to provide forage legume seeds, was a critical failure factor. Nevertheless, the interventions capacitated smallholders to engage in their own experimentation and farmer-initiated innovation processes.

In this sense, an important lesson is that the local knowledge of smallholder farmers, who are in touch with their environment, farming systems and livelihood needs, contributed to the positive outcomes.

Conclusions

From this analysis, it is clear that project-initiated innovations emerging from development programmes are worthwhile opportunities to create appropriate enabling environments to trigger farmer-initiated innovation. Smallholder farmers were able to initiate innovation processes that solved problems and to explore production opportunities that increased the benefits from their smallholder cropping systems. Furthermore, self-organisation changed the social structures to reduce the number of meetings and the time away from their farms. Importantly, the innovations specifically aimed at improving smallholder livelihoods.

The necessary condition to achieve the foregoing is that project interventions should aim at organising smallholder farmers and capacitate them to communicate farmer-identified needs, which should be addressed through specific participatory innovation development processes within development programmes.

References

- Hagmann J. 1999. *Learning together for change: facilitating innovation in natural resource management through learning process approaches in rural livelihoods in Zimbabwe*. Weikersheim: Margraf Verlag.
- Ngwenya H, Hagmann J & Ramaru J. 2009. Going to scale with facilitation for change: developing competence to facilitate community emancipation and innovation in South Africa. In: Sanginga P, Waters-Bayer A, Kaaria S, Njuki J & Wettasinha C (eds), *Innovation Africa: enriching farmers' livelihoods* (London: Earthscan), pp340–357.

The JOLISAA project was funded under European Commission FP7 Grant Agreement 245319. The opinions expressed herein are the sole responsibility of JOLISAA. More information on JOLISAA can be found at www.jolisaa.net

Rapid Appraisal of Agricultural Innovation Systems (RAAIS): constraints and opportunities for innovation in controlling parasitic weeds in rainfed rice production in Tanzania

Marc Schut^{1*}, Laurens Klerkx¹, Jonne Rodenburg², Juma M. Kayeke³, Aad van Ast⁴ and Lammert Bastiaans⁴

¹ Knowledge, Technology and Innovation Group, Centre for Integrative Development, Wageningen University and Research Centre (WUR), Netherlands

² Africa Rice Center (AfricaRice), East and Southern Africa, Dar es Salaam, Tanzania

³ Mikocheni Agricultural Research Institute (MARI), Dar es Salaam, Tanzania

⁴ Crop and Weed Ecology Group, Centre for Crop Systems Analysis, WUR, Wageningen, Netherlands

* Corresponding author. Email: marc.schut@wur.nl

Abstract

Agricultural Innovation Systems (AIS) approaches have been advocated as a framework for integrated and holistic analyses of complex agricultural problems. The potential of AIS approaches to address complex agricultural problems remains largely unexplored. One of the reasons is the lack of a coherent set of conceptual and methodological building blocks that can provide insights into the (added) value of the AIS approach. This paper presents RAAIS, an *ex-ante* diagnostic tool that can support the analysis of AIS. RAAIS provides a first characterisation of complex agricultural problems, and the agricultural system in which the problem is embedded. RAAIS offers insight into the most relevant system dimensions, multilevel interactions, and the constraints, needs and interests of multiple stakeholders. In this study, we reflect on the application of RAAIS in the analysis of parasitic weed problems in rainfed rice production in Tanzania. Semistructured interviews, farmer and extensionist surveys and multistakeholder workshops were held in three districts in Tanzania where parasitic weeds are prevalent. The results show that, in Tanzania, the national crop protection system focuses on the control of (insect) pests and diseases, and not on weed prevention, which is essential for addressing parasitic weed problems effectively. Constraints along the rice value chain concentrate around the limited use of clean (certified) rice seed, which facilitates the spread of parasitic weed seeds through the informal rice seed system. Weeds, and parasitic weeds in particular, receive little attention in the agricultural research and training system in Tanzania. Consequently, extension and crop-protection officers have limited knowledge of parasitic weeds and how to effectively prevent and control them. More general challenges relate to the lack of policy coherence and coordinated action between public and private stakeholders in the agricultural system. We conclude that RAAIS can facilitate the delineation of AIS boundaries and the effective selection and action-oriented use of other, more in-depth, systems tools to enhance innovative capacity in agricultural systems.

Keywords: agricultural innovation systems, rice, parasitic weeds, Tanzania

Introduction

Agricultural Innovation Systems (AIS) approaches have been advocated as a framework for integrated and holistic analyses of complex agricultural problems (e.g. Hall *et al* 2003). However, the potential of AIS approaches for exploring solutions to complex agricultural problems remains largely unexplored. Reasons include that AIS analyses are mostly used in *ex-post* assessments (Schut *et al* 2014), AIS boundaries are often ill-defined (Klerkx *et al* 2012) and there is limited attention for the analysis of institutional and political dimensions of agricultural innovation across different levels (Hounkonnou *et al* 2012, Schut *et al* 2013).

This paper summarises the development and testing of Rapid Appraisal of Agricultural Innovation Systems (RAAIS), a diagnostic tool that integrates and builds upon existing innovation systems methods. RAAIS provides the basis for *ex-ante* action-oriented analyses of constraints, challenges and opportunities for innovation in agricultural systems. RAAIS offers insight into the most relevant institutional and political system dimensions, multilevel interactions, and the needs and interests of multiple stakeholders. Especially the focus on multilevel interactions makes RAAIS different from, for instance, Participatory Rural Appraisal (PRA) or Rapid Rural Appraisal (RRA) tools.

A conceptual and methodological framework for RAAIS

Following the typical system definitions put forward in non-agricultural studies of innovation systems, AIS can be conceptualised as a combination of different, overlapping innovation systems with administratively, sectorally or technically defined boundaries. Administratively defined innovation systems can be subdivided along different administrative or governance levels, e.g. national innovation systems (NIS), regional innovation systems (RIS) or district innovation systems (DIS). A multilevel analysis can provide insights into how developments at one level (e.g. national level) enable or constrain space for innovation at other levels (e.g. district level). The analysis of sectorally defined innovation systems (SIS) improves understanding of the dynamics along a sector or value chain. Technical innovation systems (TIS) are demarcated by a specific field of technology or knowledge. Each of these innovation systems is analysed using the system failure framework that explores constraints and challenges that hamper innovation in systems (Klein Woolthuis *et al* 2005). Figure 1 illustrates how the different innovation systems overlap.

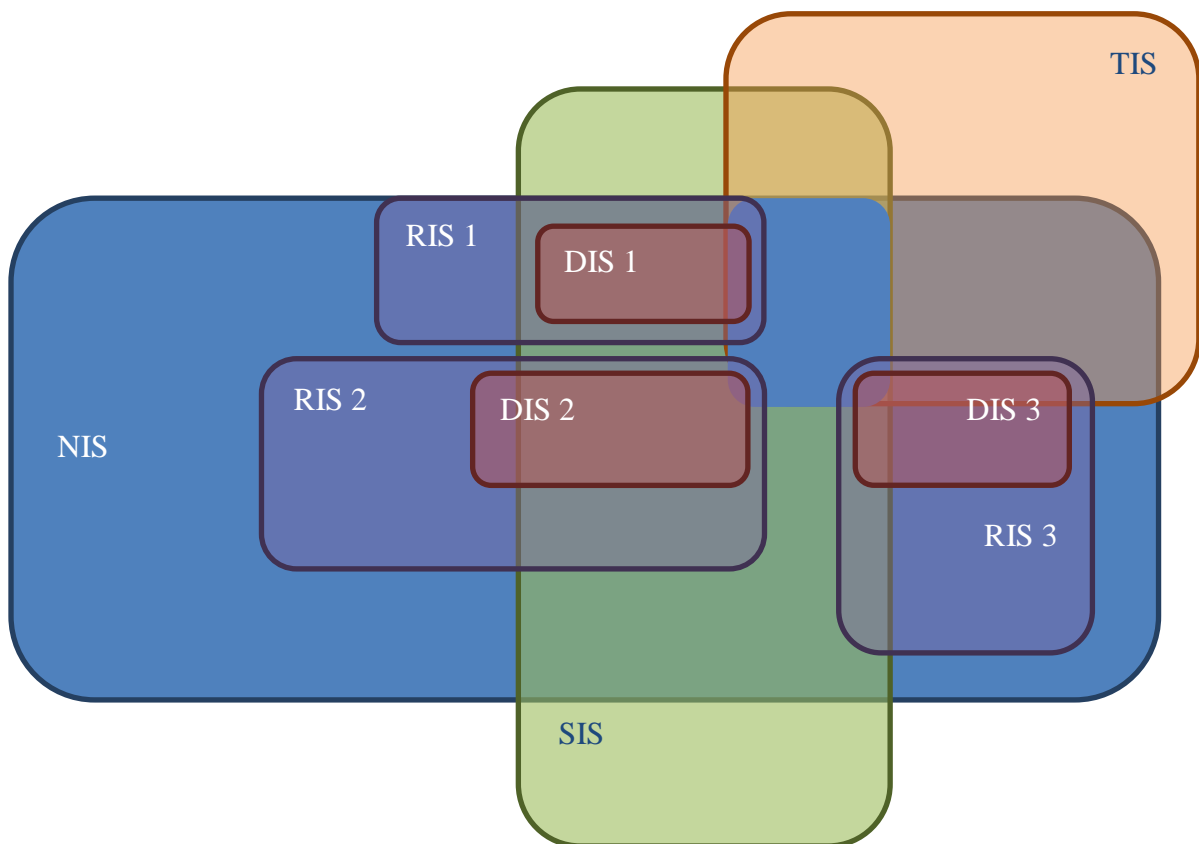

Figure 1: Conceptual framework for RAAIS with overlapping administrative (NIS, RIS, DIS), sectoral (SIS) and technical (TIS) innovation systems. The shaded square in the centre of the figure illustrates where the different innovation systems overlap.

At the core of the RAAIS methodological framework are multistakeholder workshops. The workshops take one day, during which five representatives of five different stakeholder groups (farmers/producers, government, civil society, private sector and research/training) identify and categorise constraints and challenges in the agricultural system, identify relations between them and explore opportunities for addressing the constraints and challenges. Workshops are complemented by in-depth interviews with representatives of different stakeholder groups, stakeholder surveys and analysis of secondary data (e.g. of agricultural policy or training curricula). The interviews enable the analysis of the political dimensions of agricultural innovation that are often not exposed during multistakeholder workshops. The surveys allow for more quantitative data analysis on, for instance, the quality of agricultural extension services as experienced by farmers.

Parasitic weeds in rainfed systems of rice production by smallholders offer a good opportunity to test the RAAIS framework. Parasitic weeds form a complex problem and pose an increasing threat to food and income security in sub-Saharan Africa (Rodenburg *et al* 2010). One of the countries where parasitic weeds in rainfed rice production are reported is Tanzania. In line with the conceptual framework illustrated in Figure 1, we distinguish between the national innovation system (NIS–Tanzania mainland) and three different regional innovation systems (RIS 1, 2 and 3) and district innovation systems (DIS 1, 2 and 3) representing regions and districts in Tanzania where parasitic weeds in rainfed rice production are prevalent (Figure 2).

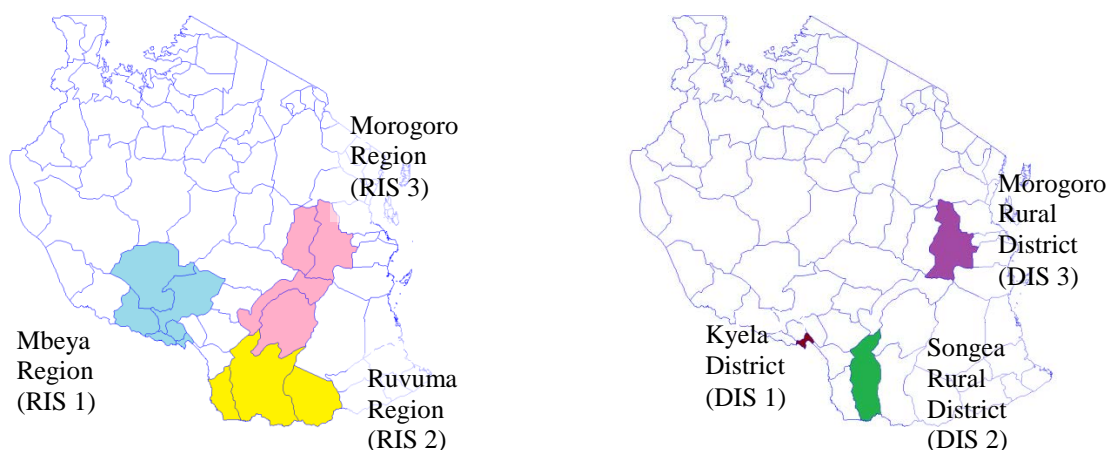

Figure 2: Map of Tanzania with the three regional innovation systems (RIS 1, 2 & 3) and district innovation systems (DIS 1, 2 & 3) where parasitic weeds in rainfed rice are prevalent

Across the national, regional and district levels, different dimensions of agricultural policy, research, training and education, extension, markets and politics were analysed. The sectoral innovation system (SIS) reflects the rice value chain, in which we analysed interactions between access to credit, inputs and services, rice production, postharvest handling, marketing, trade and export. The technical innovation system (TIS) relates to crop protection and the management of parasitic weeds in smallholder rainfed rice production. Between May and October 2012, three multistakeholder workshops (68 participants), 42 semistructured interviews, 153 farmer socio-economic surveys and a farmer-extensionist survey (120 farmers and 30 extensionists) were carried out.

Results

The majority of the farmer/producer constraints and challenges related to the district level, whereas the majority of the constraints and challenges faced by other stakeholder groups

related to the national level. The majority of national-level constraints and challenges were related to policy or education and training, for instance, “frequent policy changes” or “lack of a clear system for research-extension-farmer linkage”. National-level constraints and challenges were caused mainly by the absence or poor functioning of institutions (policies) or the lack of capacities and resources. District-level constraints and challenges were related to research, extension, and education and training. Examples are a “lack of access to relevant and coherent information for farmers” and “inadequate knowledge on the usage of farm inputs”. District-level constraints and challenges were caused by absence or poor quality of infrastructure (roads, irrigation), limited capacities and resources (funds) and institutional constraints (lack of quality control for agricultural inputs). In general, all stakeholders found that interaction and collaboration between stakeholders across different levels (e.g. between the national, regional and district levels) were very poor.

Constraints and challenges along the rice value chain were related mainly to input/service supply, rice production and rice postharvest handling. For farmers, the “unavailability and untimely supply of farm inputs” and “inadequate extension services” were among the main constraints. The limited use and availability of certified rice seed were mentioned as problematic. Parasitic weed seeds are part of the local rice seed systems and, consequently, spread relatively easily and quickly. In terms of service supply, there is insufficient extension capacity within the agricultural system to support farmers adequately.

Findings related to the technical dimensions of parasitic weed problems in rainfed rice production show that weeds in general, and parasitic weeds in particular, receive little attention in agricultural training curricula and agricultural research. Consequently, the majority of extension and crop-protection officers do not know the main parasitic weeds in rice. Furthermore, the government crop protection system focuses on the control of (insect) pest and diseases. There are no specific strategies for weed prevention, which is essential for addressing parasitic weed problems effectively.

The data provided insight into similarities and differences across the different study sites. In Kyela District, for example, farmers use less improved clean seed, as compared to the other study sites, enhancing the risk of parasitic weed seeds spreading through local rice seed systems. In Songea Rural District, the access to and quality of public extension services form a bigger problem as compared to the other study sites. More overarching constraints and challenges were related to the limited collaboration between public research, education and training, and extension across national, regional and district levels. This leads to limited coherence and coordination in agricultural policy development, implementation and monitoring and evaluation.

Opportunities and challenges related to RAAIS application

RAAIS offers insights into the most relevant system dimensions, multilevel interactions and the constraints, needs and interests of multiple stakeholders. This type of *ex-ante* action-oriented analysis can facilitate the delineation of AIS boundaries and the effective selection and use of other, more in-depth, systems methods. Collecting data across different study sites can provide the basis for general and locally adapted recommendations.

Challenges related to applying RAAIS include that it was difficult not to bias workshop participants and interview respondents in their analysis of the agricultural system. During interviews and workshops, we could not escape from providing some background on our parasitic weeds project. When facilitating the multistakeholder workshops, we paid specific attention to ensuring that different stakeholder groups could equally raise and discuss their constraints, challenges and ideas. Despite such efforts, unequal power relations and ability to debate and negotiate influenced the outcome of the workshops. A last challenge was related to the analysis of multilevel interactions. We noticed that stakeholders often frame constraints

and challenges at the level they represent and give less attention to how their constraints and challenges influence, or are influenced by, constraints and challenges at other levels.

Lessons and recommendations for dealing with parasitic weeds in rainfed rice production

In Tanzania, weeds and weed management receive little attention in agricultural research, training and education. Consequently, extension and crop-protection officers have limited knowledge of parasitic weeds and how to effectively prevent and control them. Our recommendations are subdivided in two categories: recommendations for system optimisation and recommendations for system transformation. Optimisation-oriented recommendations relate to improving interaction and collaboration between stakeholders in the agricultural sector. More attention for (parasitic) weeds and weed prevention in agricultural research and training curricula could raise awareness of parasitic weed problems and build capacity to deal with them. More transformation-oriented recommendations include the allocation of resources to improve the backstopping of agricultural extension officers, the quality control of agricultural inputs and the “cleaning” of local rice seed systems. Also, mechanisms to stimulate coherence and coordination in agricultural policy development, implementation and monitoring and evaluation are required.

Conclusions

RAAIS provides a useful first characterisation of complex agricultural problems and the agricultural system in which the problem is embedded. It sheds light on the most relevant dimensions of the agricultural system, interactions across multiple levels and the constraints, needs and interests of multiple stakeholders. This can facilitate the delineation of AIS boundaries and the more effective selection and action-oriented use of other, more in-depth, systems methods and tools, with the objective to strengthen the innovative capacity in the agricultural system. In terms of improving RAAIS, additional research on the use and integration of other methods under the RAAIS framework is required. Also, the application of RAAIS in other fields of (agricultural) research could further reveal the strengths and weaknesses of the diagnostic tool.

References

- Hall A, Rasheed Sulaiman V, Clark N & Yoganand B. 2003. From measuring impact to learning institutional lessons: an innovation systems perspective on improving the management of international agricultural research. *Agricultural Systems* 78: 213–241.
- Hounkonnou D, Kossou D, Kuyper TW, Leeuwis C, Nederlof ES, Röling N, Sakyi-Dawson O, Traoré M & Huis A van. 2012. An innovation systems approach to institutional change: smallholder development in West Africa. *Agricultural Systems* 108: 74–83.
- Klein Woolthuis R, Lankhuizen M & Gilsing V. 2005. A system failure framework for innovation policy design. *Technovation* 25: 609–619.
- Klerkx L, Mierlo B van & Leeuwis C. 2012. Evolution of systems approaches to agricultural innovation: concepts, analysis and interventions, In: Darnhofer I, Gibbon D & Dedieu B (eds), *Farming Systems Research into the 21st century: the new dynamic* (Dordrecht: Springer), pp457–483.
- Rodenburg J, Riches CR & Kayeke JM. 2010. Addressing current and future problems of parasitic weeds in rice. *Crop Protection* 29: 210–221.
- Schut M, Rodenburg J, Klerkx L, Bastiaans L & Ast A van. 2014. Systems approaches to innovation in crop protection: a systematic literature review. *Crop Protection*. 56: 98–108.
- Schut M, Paassen A van, Leeuwis C & Klerkx L. 2013. Towards dynamic research configurations: a framework for reflection on the contribution of research to policy and innovation processes. *Science and Public Policy* (in press).

Action-research platforms in water and agriculture: lessons from three programmes in Africa

Josephine Tucker^{1*}, Eva Ludi¹, Nathaniel Mason¹, Beth Cullen², Zelalem Lema², Alan Duncan², Constansia Musvoto³ and Solomon Habtu⁴

¹ Overseas Development Institute (ODI), London, UK

² International Livestock Research Institute (ILRI), Addis Ababa, Ethiopia

³ Council for Scientific and Industrial Research (CSIR), Pretoria, South Africa

⁴ Mekelle University, Mekelle, Ethiopia

* Corresponding author. Email: j.tucker@odi.org.uk

Abstract

Stakeholder platforms are popular among agricultural innovation projects. However, there has been limited critical or comparative research on these platforms, exploring what outcomes can be expected and what makes platforms effective or sustainable. This paper considers three projects (EAU4Food, RiPPLE and the Nile Basin Development Challenge) that worked with stakeholder platforms in Africa and draws a number of conclusions. Firstly, platforms can engender real change through action research and joint learning, but they also have high costs in terms of human resources. Facilitation by a trusted person, with dedicated time and resources to provide regular coordination and support to new activities, is central. This role goes far beyond just organising regular platform meetings. It is also critical to ensure that platforms provide clear benefit to members, to incentivise their participation and to have a way to influence powerholders elsewhere (e.g. in national government) who can act on learning from the platform. This may be achieved by establishing connected platforms at different levels, or by engaging decision-makers through other routes. Finally, it is important to be aware that local power dynamics will shape platform activities, e.g. farmers may not feel able to voice their concerns in front of local government officials. Facilitators may choose to remain neutral, or to actively support powerless groups, but should consider the consequences of either choice for platform outcomes.

Keywords: *innovation platforms, learning and practice alliance, community of practice, action research*

Introduction and approach to platforms

EAU4Food (European Union and African Union cooperative research to increase Food production in irrigated farming systems in Africa, 2010–15) is a transdisciplinary research programme working in Ethiopia, Mali, Mozambique, South Africa and Tunisia. It established Learning and Practice Alliances (LPAs) at district level and Communities of Practice (CoPs) at community level to: identify research questions and innovations that might increase the productivity of smallholder irrigated crop production; implement innovations and conduct joint research on their effectiveness; and translate findings into policy and practice by involving users (see Rougier & Dolinska, n.d.).

CoPs have been instrumental in identifying problems facing smallholder irrigation and potential innovations – technical and organisational – that the CoPs think could increase productivity. LPAs include higher-level decision-makers, who discuss the implications of research findings in their fields (e.g. water governance, crop selection, pest management). Innovations – novel approaches for a particular context – are tested over a number of irrigation seasons, with different degrees of collaboration between researchers, farmers and others (e.g. extension officers).

RiPPLE (Research-inspired Policy and Practice Learning in Ethiopia, 2006–11) was an action research programme focusing on water, which established a network of ten Learning and Practice Alliances (LPAs) at district, regional and national level in Ethiopia. These had overlapping membership, with each including representation of other levels, in order to share findings and bring local findings to the attention of higher-level decision-makers. LPAs involved government policy and implementation staff, NGOs, academics and the private sector. The regional LPAs identified broad research topics of importance in their region (with inputs from district-level stakeholders via cross-representation at meetings). Researchers then supported district LPA members to carry out primary research, e.g. investigating the causes of high failure rates in water schemes or evaluating the costs and benefits of multiple-use water services (for drinking, irrigation and livestock). Findings were then reported back to LPAs at all levels.

The NBDC (Nile Basin Development Challenge, 2010–13) is an applied research programme that aims to strengthen rainwater management in the Ethiopian highlands. Following baseline research that highlighted a lack of integrated, locally driven natural resource management, the project established innovation platforms (IPs) in three districts in Ethiopia in 2011. The platform members include: government experts, extension workers, farmer representatives and staff from agricultural research centres and NGOs. The purpose of the IPs is to build mutual understanding and communication among local stakeholders, pilot joint solutions to rainwater management and develop locally tailored, participatory rainwater management plans.

Community engagement activities were undertaken to enhance farmer representation and feed a wider range of community views into platforms. These included focus-group discussions, participatory video and the use of participatory planning tools (see Cullen *et al* 2013).

Platform results and challenges

In the NBDC, pilot fodder planting has yielded benefits for farmers, and there are plans to scale this up. Platform members value knowledge sharing between research organisations and government, as local actors are gaining access to external knowledge that helps them to do their jobs (e.g. researchers were able to provide local agriculture offices with help to calculate fodder requirements). But so far, IP interventions have been mainly driven by government with limited participation of farmers in decision-making. Parallel exercises have therefore been undertaken with community members, to try to ensure that their voices are heard in the process, and project staff members have worked with local decision-makers to try to build support and capacity for more participatory planning. Further, some constraints to more effective local planning are a result of higher-level policies and implementation quotas, so cannot be fully addressed at district level (Ludi *et al* 2013).

Under RiPPLE, several regional- and district-level practices were changed based on participatory generation of evidence by LPAs, e.g. water office budgets at district level were increased, more reliable pump technologies were adopted, multiple-use water services were introduced and storage facilities were developed for perishable crops. Sometimes, the private sector also acted on the findings, e.g. new buyers came to purchase irrigated vegetables after a local monopoly was uncovered (Tucker *et al* 2013). It should be noted, however, that not all research projects undertaken through LPAs led to such changes, and that the successful examples often, but not always, involved intensive engagement by LPA facilitators with decision-makers.

LPA members involved in the research emphasised how much they learnt from the process, and two-way learning between academics and practitioners was evident. However, it is hard to determine whether systemic change has taken place in terms of institutional collaboration and communication, or whether the changes have been scaled out. Few projects allow budget

for long-term monitoring and evaluation of the impact of platforms, and the majority of platforms established by RiPPLE were disbanded due to a shortage of funds once the project ended in 2011 and RiPPLE transitioned into an independent NGO seeking its own funds. Two, however, have been sustained: the national-level Forum for Learning on Water and Sanitation, which was fully endorsed by the Ministry of Water and Energy and so has attracted further funding, and one of the regional-level LPAs, which has been supported under a follow-up project. In addition, new LPAs have been established in new districts, under new projects, which all remain linked to the national platform to share experiences.

The EAU4Food platforms are at an earlier stage, but with activities underway; for example, in Ethiopia, alternatives to currently practised water scheduling in irrigation systems are being tested on farmers' fields. In the second irrigation season, adjustments to the alternative approach are made based on results and insights from the first irrigation season achievements. Involvement of farmers in the experiment is crucial, as their buy-in will be required if major modifications to the way irrigation water is distributed and applied should be suggested at a larger scale. In South Africa, experimentation is also underway at field level. As the process gains momentum, a key challenge is to ensure consistency of participation of the different stakeholders from meeting to meeting. Invitations are often made at the institutional level for reasons of protocol, which can result in different individuals attending each meeting. Even for private stakeholders, notably individual small farmers, there has been limited consistency in attendance. The provincial Department of Agriculture has taken responsibility for inviting farmers to the meetings, making it difficult for project staff to target individual farmers directly. The time required for attending meetings, transport logistics and the time lag between problem identification and the emergence of lessons (i.e. the point at which benefits start to accrue to participants) may also play a role.

Conclusions

Platforms can have different aims, e.g. promoting intersectoral collaboration, increasing farmer participation in planning, or linking actors in value chains. Each requires different approaches and membership. There is no single recipe for how a platform should be structured and organised; rather, the starting point should be the purpose of the platform. One common ingredient, however, is effective and intensive facilitation to maintain interest and commitment to the platform and to ensure that all stakeholders feel represented. A successful platform is about ongoing collaboration and communication, of which periodic platform meetings are only one part, and strong facilitation is needed to build and maintain this level of interaction. A person who is trusted by all stakeholders should be appointed as facilitator, with dedicated time and resources for facilitation. This means that the human resource costs of running platforms are high, and these costs need to be weighed against expected outcomes. This also means that government offices may be unwilling or unable to continue to fund platforms after the end of donor-funded projects, even if the platform is valued.

Platforms can initiate joint action research involving farmers, academic researchers and government, which increases the understanding and appreciation of farmer knowledge and of realities on the ground. It also helps create new networks and builds research capacity, but longer-term monitoring is needed to find out whether the use of research and evidence in decision-making increases over time. Joint generation of evidence by stakeholders, based on demand and validated by platform discussions, can create acceptance of research findings, even uncomfortable ones, and promote action. Experience-sharing events and field days can then help to spread innovations horizontally. Action research and piloting take place mostly at local level, but local platforms need a way to engage higher-level decision-makers, as policy and budget issues from above are often important factors that constrain local opportunities for action. Beneficial synergies can be created with platforms at multiple interconnected levels, as demonstrated by the RiPPLE programme, or connecting with other

existing institutions may be preferred. The key is to identify who holds the power to drive change and find a way to engage them.

Platform activities need to offer some short-term benefit to members to incentivise participation, e.g. the promise of solving a pressing problem (e.g. failed water schemes) or of generating livelihood benefits (e.g. increasing fodder supply or improving the productivity of irrigated agriculture). This is a particular challenge for platforms whose main focus is on improving natural resource management, from which benefits accrue only in the long term, and specific activities may need to be designed which link these broader aims with immediate livelihood benefits, as demonstrated by the NBDC investments in fodder development. Even where livelihoods are the focus, if there is a long time lag between problem identification and the development of solutions, some participants may lose interest.

Existing power dynamics may affect platform outcomes. Platforms can make these power dynamics visible, but alone are unlikely to transform them, even with intensive efforts by external support agents. Platforms may seek explicitly to support less powerful groups to challenge existing structures, or just provide a neutral space where this might happen. Government offices in particular often play a leading role in platforms, which has advantages in terms of facilitation of activities, championing the process and enhancing the prospects for eventual adoption and upscaling of solutions, but it is important to ensure that other voices are not suppressed.

Finally, there is a need for much more systematic and long-term monitoring and evaluation to really understand the effectiveness and impacts of platforms. Projects can initiate platforms but their long-term impact depends on whether local champions adopt and sustain the process, so identifying and supporting these people is important.

References

- Cullen B, Lema Z, Tucker J, Snyder K & Duncan A. 2013. Navigating power dynamics in innovation platforms: lessons from the Blue Nile Basin, Ethiopia. In: Triomphe B, Waters-Bayer A, LeBorgne E, Klerkx L, Schut M, Cullen B & Kamau G (eds), *Innovation in smallholder farming in Africa: recent advances and recommendations* (Montpellier: CIRAD), pp80–86.
- Ludi E *et al.* 2013. Rhetoric versus realities: a diagnosis of rainwater management development processes in the Blue Nile Basin of Ethiopia. Colombo: Research for Development (R4D) Series 5, CGIAR Challenge Program on Water and Food (CPWF).
- Rougier J & Dolinska A. n.d. *Communities of practice: key concepts Version 7.0*. Montpellier: Lisode.
- Tucker J, Le Borgne E & Iotti M. 2013. Policy and practice influence through research: critical reflections on RiPPLE's approach. In: Calow R, Ludi E & Tucker J (eds), *Achieving water security in Ethiopia: lessons from action research in water, sanitation and hygiene* (Rugby: Practical Action Publishing), pp173–193.

Project websites:

- www.eau4food.info
- www.rippleethiopia.org
- www.nilebdc.org

Lessons learnt about collaborative research from the EU project JOLISAA (JOint Learning in Innovation Systems in African Agriculture)

Jolanda van den Berg^{1*}, Conny Almekinders², Anne Floquet³, Nour Sellamna⁴, Simplicie Davo Vodouhê³, Geoffrey Kamau⁵, Brigid Letty⁶, Joe Stevens⁷, Gerrit Rootman⁸ and Bernard Triomphe⁹

¹ Wageningen UR, Agricultural Economics Research Institute, The Hague, Netherlands

² Wageningen UR, Knowledge, Technology and Innovation Group, Wageningen, The Netherlands

³ Université d'Abomey-Calavi, Faculté des Sciences Agronomiques, Cotonou, Bénin

⁴ International Centre for development oriented Research in Agriculture, Montpellier, France

⁵ Kenya Agricultural Research Institute, Nairobi, Kenya

⁶ Institute of Natural Resources, Scottsville, South Africa

⁷ University of Pretoria, Department of Agricultural Economics, Pretoria, South Africa

⁸ Limpopo Department of Agriculture, Towoomba Research Station, Bela Bela, South Africa

⁹ CIRAD UMR Innovation, Montpellier, France

* Corresponding author. Email: jolanda.vandenbergh@wur.nl

Abstract

The increased concern about the capacity of (inter)national agricultural research to create societal impact urges research to reflect on its role in society and to adopt an innovation systems approach, enhancing multilevel stakeholder learning and negotiation for new technologies and institutional and organisational arrangements (e.g. World Bank 2012). But what does this mean for practice? This paper reflects on the joint learning process undertaken by a research consortium consisting of three African national research teams and four European teams. Its purpose was to study innovation processes in the framework of the EU-funded multipartner project JOint Learning in Innovation Systems in African Agriculture (JOLISAA). The project was implemented in 2010–13 in Benin, Kenya and South Africa, where innovation cases were inventorised, selected, screened and collaboratively assessed by multistakeholder teams. Results indicated that researchers learnt about innovation from the cases they studied and about the interaction with the stakeholders in the individual case assessments and from other collaborative assessment teams. The project duration was too short and the resource base too limited for adequate development of the concepts used, and the diverging views on what joint learning in the project meant hindered the development and implementation of a learning agenda. We conclude that integrated multistakeholder approaches that combine participatory research activities with reflective learning and capacity building for all research participants are highly desirable but not easy to implement. They require longer timespans to develop effective partnerships.

Keywords: *agricultural innovation systems, collaborative research, reflexive monitoring, capacity building*

Introduction

There is an increased concern about the capacity of (inter-)national agricultural research to generate societal impact. Despite heavy investments over several decades, the technology-transfer approach to development showed limited success in improving the livelihoods of poor farmers living under diverse risk-prone conditions in developing countries. Even the subsequently emerging locality-specific participatory research approaches did not meet the expectations. This urges research to reflect on its role in society and to adopt more effective approaches, such as an innovation systems approach aimed at enhancing multilevel stakeholder learning and negotiation for developing and implementing new technologies and institutional and organisational arrangements (World Bank 2012).

This paper reflects on a joint learning process of three African national research teams and a group of four European research teams in studying innovation processes in the framework of the EU-funded multipartner project JOint Learning in Innovation Systems in African Agriculture (JOLISAA), implemented in Benin, Kenya and South Africa in 2010–13. The objective of the project was to better understand the role of different types of knowledge in innovation processes, in particular the interaction of local and scientific knowledge, through the analysis of a series of innovation cases in the three African countries. The team process of collaborative case assessment with a heterogeneous group of stakeholders in smallholder agricultural innovation, including farmers and farmer organisations, entrepreneurs, extension workers, NGO staff and policymakers, represented a multilevel and nested learning opportunity for the JOLISAA researchers themselves to further build their capacities to engage in multistakeholder innovation. The study reported in this paper meant to:

- Critically reflect upon the JOLISAA joint learning approach;
- Gain insight into the actual roles/tasks of the researchers and other stakeholders in the learning process; and
- Identify strong and weak points of the JOLISAA learning approach in creating social capital for local innovation.

To generate in-depth knowledge about the experiences of the JOLISAA researchers in the learning process described above, national team members were interviewed. Additional individual interviews were held with European team members, with research collaborators and with stakeholders from selected innovation cases assessed by JOLISAA. Timelines were constructed during these interviews according to perceived critical moments for learning together and served to reflect on individual learning expectations, roles and tasks, learning practices and challenges experienced in the project.

Methodological framework

The programme had three phases: the first phase served to develop the concepts and methodology, the second phase served to make the inventory of innovation cases and the third phase to collaboratively assess a number of selected innovation cases. Joint learning in the JOLISAA project was conceptualised as three learning cycles around these phases (Figure 1). The arrows indicate that the outcomes of one learning cycle were expected to feed into the next learning cycle and feed back to the previous learning cycle to optimise knowledge building around smallholder agricultural innovation processes and drawing lessons from them. There were four types of encounters around which the learning was to take place:

- A series of three global workshops where members of the international coordination team met with international stakeholders in agricultural innovation (e.g. research and development funders, policymakers) and innovation experts, both members and non-members of the JOLISAA International Learning and Advisory Circle (JILAC);
- A series of nine national workshops (three per country) where members of the national coordination teams together with representatives of the international coordination team and preferably JILAC members met with national and local stakeholders in agricultural innovation, both members and non-members of the national learning circles;
- A series of 13 local workshops (one per individual innovation case) where JOLISAA researchers and so-called “innovation caseholders” (or resource persons) met with farmers and other stakeholders in selected innovation processes;
- Two structured and various spontaneous electronic discussions between the international coordination team (which included members of the national coordination teams) and JILAC members.

During Phases 1 and 2, particularly during the first and second rounds of national workshops (late 2010 and late 2011, respectively), participants identified four issues as being crucial for optimal learning between JOLISAA researchers and non-researchers:

- The selection of a range of participants (heterogeneous learning groups): bringing together people with different perspectives, knowledge and experiences;
- A high level of participation and ownership of learning issues and methods (developing a shared learning agenda), to ensure a strong interest on the part of the participants in the learning issues at stake;
- Good facilitation: opportunities for competence building;
- Time for reflection on the learning process: reflexive monitoring to optimise the learning process as it unfolds.

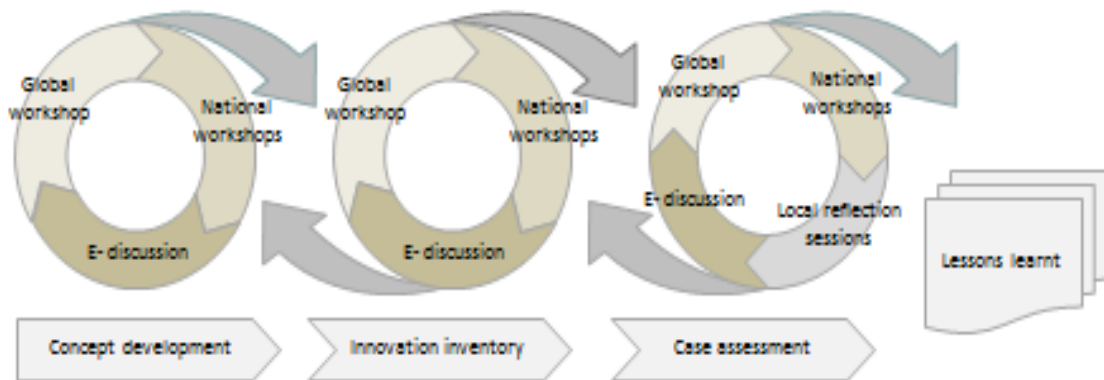

Figure 1: JOLISAA approach to joint learning: learning cycles around the main research phases (Source: Berg *et al* 2011)

Especially the third phase of JOLISAA, the collaborative case assessment (CCA), was perceived as the major opportunity for joint learning between researchers and other stakeholders in the innovation cases. The CCA approach and guidelines (Triomphe *et al* 2012) referred to the development of a shared research agenda by JOLISAA researchers and innovation stakeholders, mutual agreement on the roles/tasks to be performed by researchers and non-researchers, and joint analysis and interpretation and validation of results.

Main results

Interview results show that the general joint learning approach as defined at the level of the JOLISAA project was used in practice by the country teams for different objectives. The Benin team aimed at creating a supportive national institutional and policy environment. The Kenya team aimed at building national researchers' capacities in innovation-oriented approaches. The South Africa team aimed to learn jointly about the effective facilitation of multistakeholder innovation processes so as to be able to inform policy and practice.

Overall, JOLISAA researchers felt comfortable in doing participatory research and organising consultation meetings to discuss findings at case level (as part of CCA) or at national level. However, in hindsight, they recognise that they always remained in the driving seat: as “brokers” in the meetings, they took the initiative, designed, planned and largely controlled the entire collaborative research and learning process. The strategy of JOLISAA researchers throughout the project and in the interaction with other stakeholders was shaped by the outcomes the JOLISAA team had proposed to the EU: to generate detailed information on the selected innovation processes and to inform policymakers and other innovation stakeholders, particularly the research community. This left little space (i.e. time and budget) for integrative learning within and among the research teams, and learning and negotiation with local stakeholders about the issues at stake. Also, because of the limited availability of

time and resources, it was not possible to engage in actual action research, thereby significantly restricting opportunities for more intense joint learning and direct contribution to change.

Challenges encountered

Reflecting on the experiences in the JOLISAA project, the researchers perceived several key challenges for joint learning:

- Diverging views among JOLISAA research partners about what joint learning is, what it should achieve and how it could or should be accommodated in the JOLISAA project;
- Limited joint (field) research by the research partners and innovation stakeholders to arrive at shared concepts, learning agenda and research- and learning methods;
- Too little time and financial resources for:
 - Researcher-stakeholder interactions around individual cases of innovation and learning processes
 - North–South and South–South interactions.

Key lessons

Also the European partners had diverging views on the place of joint learning in the project. Those who were from research organisations had, as a priority, the scientific output of the project. Others were more committed to capacity building through joint learning. These different priorities and interests could be accommodated through differentiated participation in the various events and “Work Packages”, the labels for subprogrammes within EU projects. JOLISAA researchers in Kenya and Benin went beyond their conventional research roles and mandate (in this project: to learn about innovation processes) and included a commitment to improve the livelihoods of smallholder farmers. They also engaged in providing relevant knowledge to support local innovation and to develop new capacities, such as building institutional capacity and stimulating learning among innovation stakeholders. The South African research team gave less attention to multistakeholder learning and prioritised the learning about how the selected innovation processes unfolded, the impacts they had and the challenges that were encountered. In the context of South Africa, there is limited understanding around the role of farmers, in particular in smallholder agriculture. According to the JOLISAA team, bringing out information to sensitise the research and policy community was therefore the first and most important step to make.

Despite the hindrances to effectively pursuing their goals, most JOLISAA partners acknowledge that the project was relevant to them, as individuals and as organisations. However, it was time-consuming to arrive at mutual understanding. This mutual understanding did not mean “convergence” of views, but rather understanding each other’s view. Overall, the partners felt they had gained a better idea of what innovation means, especially through the comparison of cases and the different approaches that were taken to assess the cases. Many said that far too much effort went into the first phase of the project but, all being new to each other, this period in which the partnership needed to be forged could not have been any shorter.

Conclusion

Integrated multistakeholder approaches that combine participatory research activities with reflective learning and capacity building for all research participants are highly desirable but not easy to implement. They require advanced thinking and mutual agreement on the level of participation, and learning methods and a flexible positioning of the research activities in multistakeholder processes in order to ensure a methodology most fit for evolving issues at stake and the surrounding sociopolitical context (Paassen *et al* 2011). They require longer timespans to develop effective collaboration. However, the project-based and output-oriented

working make an ill fit with rather complex setups with various partners and using integrated multistakeholder approaches. Under pressure of time, “programmed” learning is easily squeezed and does not receive the attention it merits for useful reflection.

References

- Berg J van den, Harms B, Sellamna N, Triomphe B & Vodouhê DS. 2011. JOLISAA approach to joint learning in agricultural innovation research: an interplay between knowledge building, networking and capacity building. JOLISAA Working Paper. Montpellier: CIRAD.
- Paassen A van, Werkman R, Pedroli B, Berg J van den, Steingröver E & Leeuwis C. 2011. Conclusion: from knowledge for action to knowledge in action. In: Paassen A van, Berg J van den, Steingröver E, Werkman R & Pedroli B (eds), *Knowledge in action: the search for collaborative research for sustainable landscape development*. Mansholt Publication Series Vol. 11. Wageningen Academic Publishers.
- Triomphe B, Berg J van den, Kamau G, Floquet A, Letty B & Bridier B. 2012. Approach and guidelines to collaborative case assessment. JOLISAA Internal Project Document, Montpellier: CIRAD.
- World Bank. 2012. *Agricultural innovation systems: an investment sourcebook*. Washington DC: World Bank.

The JOLISAA project was funded under European Commission FP7 Grant Agreement 245319. The opinions expressed herein are the sole responsibility of JOLISAA. More information on JOLISAA can be found at www.jolisaa.net

SECTION 4: POLICY IMPLICATIONS AND POLICY DIALOGUE

One session in the AISA workshop was devoted to preparing key policy messages and recommendations for different groups of stakeholders to stimulate agricultural innovation processes and systems in Africa. Some of the policy implications are further addressed in the Living Keynote (see next section) and in the conclusions.

For each “target” group, a subgroup of participants (not necessarily from that target group) discussed key insights, messages and recommendations regarding agricultural innovation systems, as well as some ideas to ensure that the target groups act upon them. Each group named one member to bring forward their points on their behalf. Then, in the plenary, in a closed “fishbowl” in the midst of the other participants, the group spokespersons shared the issues. The messages formulated for academia, agricultural advisors/NGOs, capacity developers, donors, farmer organisations and the private sector are shown in Box 6.

Box 6: Messages aimed at different target groups about AIS in Africa

Academia

- Value innovation processes and engagement (reward systems) – ensure interaction and learning with farmers
- Engage all stakeholders (farmers, private sector, NGOs, government) in the research and development processes, i.e. use an integrated approach, and – at the core – learn from farmers
- Seek collaboration among academia and researchers along the value chain

How to act upon this?

- Practical training in the universities to deal with real issues and problems
- Partnerships with other players (NGOs, microfinance, local innovators, private sector)
- Involve industry/private-sector players, NGOs and CGIAR in teaching and training

Advisors (extension, NGOs etc)

- Strengthen technical and advisory skills of extension by strengthening curricula and through lifelong learning in professional organisations
- Ensure that complementary roles are known and acted up on by hubs, adviser networks, face to face, facilitating a reflection on this issue
- Support brokerage roles: horizontally, vertically, in a complementary manner

Some background information to these messages:

- Develop broker/facilitator role – especially in NGOs with broader picture
- Autonomization
- Autonomisation
- Know when to phase out
- Be open to recognition of working in alliances
- Strengthen service providers to wear different hats
- Strengthen horizontal and vertical complementary (e.g. value-chain) coordination
- Strengthen individual learning and social learning, and create space for reflection
- Seek complementarity

Box 6 (cont.): Messages aimed at different target groups about AIS in Africa

Capacity developers – *Goal: to build capacity of innovations systems*

- Brokerage institutions and training/education institutions are responsible for building capacity of the innovation systems
- Capacity building does not mean training; it means developing institutional systems and incentive structures in countries
- "Training" + capacity development means building “soft skills” such as partnership, “collaborativeness”, etc.

Donors – *Innovation platforms are dynamic but donors require details upfront!*

- Invite the donor world to the “process” so we all understand each other, and build trust based on evidence and ultimately **confidence!**
- Provide a budget and reporting structure that embrace the process (rather than outcomes) – and include an evaluation of such process
- IPs allow us to focus on real issues and with potential benefits (this relates to risk)

Some background information to these messages:

- Trust the process! Provide the evidence based on existing work/impact
- Honesty about risk
- Process orientation: blank cheque for first few years
- Process based not only on technology or number-based
- Coordination among donors and visions
- Share/communicate information (to donors)
- Financial-based reporting restricts multidonor projects
- Longer-term support in phases (with evaluation)
- Invite donors to the process, educate them and build their confidence
- Consider the costs of the innovation platform process

Farmer representatives

- They should engage researchers directly to articulate farmers' needs and set the agricultural research agenda, as it enhances ownership.
- They should be lobbying the government and other key agricultural actors to address challenges that affect them.
- They should catalyse and spearhead farmer groups to establish innovation platforms.

How to act upon this?

- Establish and strengthen structures at various levels from grassroots to national level
- Establish effective communication mechanisms that allow for feedback
- Use social and mass media

Private sector

- Be curious about what's happening around you
- Be part of innovation platforms to help solve your problems – some IP members may have some answers that you're looking for
- Business opportunities within the agricultural sector

How to act upon this?

- Join the Chamber of Commerce
- Corporate Social Responsibility projects

In the discussion about the issues raised in the fishbowl, it was pointed out that many of these recommendations have been made in the past, but they are not being picked up by decision-makers/policymakers. Understanding what went wrong is important if we want to be more effective in the future. Is there something wrong with the approach we are promoting? Is the message poorly conveyed? Are we not addressing the right people in the right way?

At the same time, the poster session showed that innovation platforms are being implemented in many places and projects, even though they may not always function particularly well. Ideas and interventions are emerging from researcher-driven innovation platforms that do not fit the circumstances of smallholder farmers. It was suggested that, rather than always making new platforms, we should try to link up with existing structures that are farmer-driven, such as farmer associations.

As for the issue about whom to address: we (beyond the workshop participants, those engaged in R&D and support to innovation, usually through interventions) talk to “them”, but “they” remain abstract for us. Who are “they”? Moreover, what we say remains abstract to many policymakers. We should bring them to the places physically to see what we are doing together with smallholder farmers. We should invite key players to events where policymakers can interact with farmers. We should also provide evidence on a sufficient scale to show the usefulness of innovation approaches and platforms. Action research should provide such evidence. We should ensure that government actors feel a sense of “ownership” of innovation processes. We should invest more attention and time in lobbying for favourable innovation policies, especially at national level. It is important to target key players carefully (e.g. those who are in taskforces preparing strategy papers) and to make sure that the right person is telling the story to them. We also need to make sure that information on the approaches and achievements in agricultural innovation processes are available in a timely manner and are appropriately packaged.

Note: Some of the policy implications are further addressed in the Living Keynote (next section) and in the conclusions.

SECTION 5: SEVEN CRITICAL ISSUES FOR ENHANCING INNOVATION IN SMALLHOLDER FARMING – OUTCOME OF THE LIVING KEYNOTE PROCESS

Note: This text was edited by Bernard Triomphe and Ann Waters-Bayer, based on inputs from workshop participants, individual issue “owners” (see credits under each section) and Peter Ballantyne (facilitator of the Living Keynote dynamics –see page 3 for a description of the corresponding process)

Introduction

Seven critical issues to take into account when trying to enhance innovation in smallholder farming in Africa were identified and debated during the AISA workshop: they include:

1. Innovation drop zones? Dealing with interventions “parachuted” into situations without due appreciation of and embedding into local realities
2. Life under the hedge? Missing endogenous innovations occurring under the radar of innovation “experts”
3. Follow the bright lights? Fitting current enthusiasms, e.g. for market-driven innovation, to all circumstances
4. Surf the wave? Balancing more directed and output-driven innovation projects with more opportunistic outcome-oriented innovation processes
5. Brain gain? Strengthening capacities to innovate and to facilitate innovation processes
6. Suspended motion? Monitoring, evaluating, adjusting, learning and reflecting on innovation results, outcomes and impacts
7. The ripple effect? Scaling innovation up and out ...

Among them, they cover strategic issues which are debated, sometime vigorously, in both in the international and the African AIS and ARD communities of practice, which involve both academics and practitioners of various profiles and walks of life.

This paper provides explanations about the formulation of the issue, food for thought and sometimes concrete answers and suggestions about these seven issues on the basis of the “Living Keynote” (LK) process described in the introduction to these proceedings. Not all issues have been addressed and framed in the same way in the paper: some are quite faithful to the discussions held during the workshop and to the cards collected by the “issue owners” and posted on the Living Keynote Wall. Others are somewhat more academic, owing to the fact the issue owners also tapped into theory and evidence from the literature. Also, some sections focus mostly on characterising the issues at hand, while others also include recommendations about how to deal with them.

Such heterogeneity of framing and output is probably typical both of the experimental nature of the LK process, and of the mixed nature of the collective expertise arising from AISA participants, researchers and practitioners alike, that the LK process was able to draw upon. Finally, one should note that the subsequent text is just but one output of the intense knowledge exchange and social learning that went on during the workshop about the seven issues discussed below, and which cannot be neither adequately nor exhaustively captured in written workshop proceedings.

1. Innovation drop zones?

Dealing with interventions “parachuted” into situations without due appreciation of and embedding into local realities¹⁷

In agricultural innovation processes, a recurring issue is the frequently observed mismatch or gap between, on one hand, the local innovation dynamics of rural communities, smallholders and other local stakeholders and, on the other hand, the interventions made by external stakeholders with the intention of stimulating innovation.

Interventions by government services or projects often aim at introducing new technologies developed on-station by researchers or transferred from elsewhere and/or new ways of organising and mobilising local people (such as by linking them to markets). This is usually done with the aim of addressing local and global challenges, such as reversing resource degradation, increasing food security and improving livelihoods. Often, the people intervening give insufficient attention to trying to understand the local context and the actual needs and desires of the people for whom the interventions are intended. Initial diagnostic studies focus on “problems” but usually pay scant attention to local dynamics, such as existing innovations and innovators, linkages among different actors or knowledge-sharing mechanisms. Hence, such studies tend to propose activities and “solutions” that do not build on the local dynamics.

Under such conditions, one can refer to many interventions as being “parachuted” into local landscapes. Parachuting has its merits (such as offering an opportunity to get out of deadlocks, introducing new ideas, or bringing in much needed expertise and resources). However, it is one of the key causes for low or unsustainable adoption rates of introduced technologies and/or for lack of persistence of introduced organisational structures (e.g. farmer groups, multistakeholder platforms), especially beyond the timeframe of the intervention. Technology adoption rates and activities of project-organised farmer groups may be artificially high during the intervention because the project creates a temporary “enabling environment”, e.g. (subsidised) provision of inputs, credit or advisory services, facilitating linkages to market, and other kinds of facilitation of the innovation process. But once this artificial “enabling environment” falls away (i.e. the project ends), reality kicks in again.

To avoid this, interventions need to be preceded by investment in gaining “sufficient” understanding of the local context in terms of the cultural and social landscape, the stakeholders involved and the networks in which they are active, and the existing innovation dynamics. An attempt should also be made to assess the likely or potential positive and negative consequences in different dimensions of introducing a certain technology or new form of organisation or of solving a certain problem in a particular way. For example, designing a cattle improvement project in some parts of South Africa requires consideration of the cultural implications for female owners of livestock, as women are traditionally not allowed to enter a cattle kraal.

Organisations making interventions need also to be aware of the multifaceted nature of innovation, which has both technical and non-technical elements that are closely intertwined. For example, introducing a new yield-improving production practice may (need to) give rise to a new marketing strategy that allows farmers to sell the surplus of the increased production. Having a good understanding of the local context makes it more likely that an intervention can be adapted to address such issues as they arise

Setting up multistakeholder platforms is one mechanism that can contribute to improving the correct “landing” of an intervention in a local landscape and longer-term sustainability after the intervention. Platforms are vehicles for exchanging ideas, identifying solutions to

¹⁷ Original text developed by Brigid Letty (INR)

constraints encountered and *ex-ante* evaluation of proposed interventions, and engaging in joint action and “learning by doing”. They allow different stakeholders – both local and external – to have a voice. Together, platform members are more likely to identify in advance some issues that could affect the proposed interventions and to come up with adapted and acceptable ways of dealing with these issues.

But platforms can bring these benefits only if they function effectively. When they are set up, careful consideration needs to be given to the local context, the different stakeholders and the existing structures that can represent them, the role they may play in the platform and how to handle power relationships among them. Another key aspect to consider is who should be responsible for convening and facilitating the platform – and this may change over time.

Initially, an external facilitator or broker may be needed, but working gradually toward local ownership of the platform is key to its effective operation and sustainability beyond the timeframe of the intervention. This may be achieved by encouraging local champions to emerge as convenors and/or facilitators of the platform and by strengthening their skills in managing the interactions (including tensions and conflicts) between stakeholders and in brokering linkages with other actors.

Besides multistakeholder platforms, other mechanisms and approaches may contribute to mitigating the problem of “parachuted” interventions. One possibility is to ensure that innovation processes build on local initiatives and motivations. For example, existing innovations initiated by smallholder farmers can be a good entry point for interventions. Many such innovations can be improved further through the involvement of different actors with different types of knowledge and experience. For example, interventions could build on what farmers are already doing to improve their yields as a starting point for testing ideas from external agents.

While much can be done locally to improve agriculture, innovations (and interventions) usually require a favourable (enabling) policy environment to be effective. Apart from supporting the development of technological innovations themselves, establishing and facilitating multistakeholder platforms (a social innovation in itself, or, depending on the outlook, a change in the enabling environment) may require policy and institutional support to ensure that the necessary resources are made available, including for the initial diagnosis of the local landscape. Policy and institutional support may also be needed so that individuals working in an organisation within a multistakeholder platform can actually take on non-traditional roles such as brokering linkages between different actors. Finally, policy support or policy change is needed to encourage open-ended innovation processes and diverse types of interventions and activities, in which the exact nature of the innovation process and its outcomes are not predetermined but rather respond to other needs and opportunities that emerge.

In essence, interventions should be planned and implemented in a way that builds on existing dynamics and initiatives, allows for effective sharing of insights and ideas of different stakeholders – especially the local people involved – and allows for the innovation process to change course as additional or new challenges or opportunities emerge during the process.

2. Life under the hedge?

Missing endogenous innovation occurring under the radar of innovation “experts”¹⁸

When assessing a situation or planning an intervention, innovation professionals or “experts” tend to focus on innovations that are already known and much talked about at international level, e.g. conservation agriculture, modern aquaculture, establishing value chains to access

¹⁸ Original text developed by Marc Schut (WUR)

export markets, developing organic farming and commercialisation. Conversely, they tend to ignore local innovations, which for the most part remain invisible or unknown to them – in other words, endogenous innovation processes that occur “under the radar”.

Yet agricultural innovations, small or big, are being developed everywhere. Many people – low-profile “ordinary” farmers, whether individually or in groups – continuously seek spaces to improve their livelihoods or the performance of products, processes and organisations. Innovation also comes from outside the agricultural sector (e.g. financial and information services provided to farmers through cellular phones). Another reason for innovation to be under the radar is that some innovators may want to keep, if only temporarily, their innovations invisible to others (e.g. until they “get it right” or perhaps they hope for intellectual property rights or patents). Different initiatives, most notably PROLINNOVA and to a lesser extent JOLISAA, illustrate the range of local innovations and innovators that are currently under the radar (see www.prolinnova.net).

However, in many such initiatives, the tendency so far has been to identify and document local technical innovations (e.g. development and use of a local egg incubator). Local socio-organisational innovations (e.g. in terms of new communication structures, rules, local organisation) tend to be less explored, probably because these are even less visible and tangible to “outsiders” than are technical innovations, and also because local innovators themselves may not talk much about this type of innovation to outsiders whom they regard as technically oriented. Indeed, it is highly unlikely that local people would refer to such changes as “innovations”, which poses the questions as to of **who** defines what innovation is all about, and of **what** is regarded as “innovation” by different stakeholder groups.

As documentation and promotion of local innovation becomes more common, a critical question is whether the very idea of putting “under-the-radar” innovations “on the radar” is feasible and useful. On one hand, making currently under-the-radar innovations visible could bring many benefits. It could extend significantly the range of innovations being developed through multistakeholder partnerships. It could stimulate further innovation by smallholder farmers, as locally developed ideas using available resources are likely to be more easily disseminated, taken up and adapted by other local people than are many external innovations that depend on external inputs and support. It could contribute to empowering local people, by shifting their status from simple beneficiaries of interventions to major contributors in development and economic growth, on a level similar to the more conventionally recognised contributors such as research scientists, extension officers or the private sector.

However, innovations “under the hedge” (or “in the social wild”, as one workshop participant put it: Sherwood et al., 2012), as opposed to new ideas introduced and further developed through interventions, are embedded in different dynamics. Under-the-hedge innovations are locally suitable and often have some degree of flexibility in terms of their ability to adapt to changing contexts. These innovations often result from local champions, who develop, test, market and adapt their innovations continuously. These innovators are more often than not committed to “development” (in the sense of improving the situation of farmers in general) and many of them are willing to share their ideas at least in their personal networks. The question hence is whether these qualities of, and prerequisites for, successful local innovation can be preserved once such innovations are put “on the radar” and become models for interventions. Also, it seems clear that not all under-the-radar innovations have the same potential for being put on the radar.

Whatever their specificities, both under-the-radar and on-the-radar innovations can contribute to agricultural development. To enhance agricultural innovation, the challenge is to create an enabling environment that can strengthen the innovative capacity of different stakeholders interacting with each other and operating across different scales and levels. For example,

improved access to different types of innovation grants (see Macoloo *et al* 2013) could stimulate both under- and on-the-radar innovation at the local level.

3. *Follow the bright lights?*

Fitting current enthusiasms, e.g. for market-driven innovation, to all circumstances¹⁹

Approaches and underlying assumptions adopted for supporting rural development and innovation funded by major donors tend to have significant similarities within a short period of time. For example, linking farmers to markets was initially championed by one donor and given plenty of hype and soon many donors were pushing through calls and projects to link farmers to markets. Market-based approaches (MBA) have indeed become the “flavour of the year” or even the “flavour of the decade” for many donors. Another current fad in the AIS context is the “innovation platform” (IP), developed as a seemingly simple way of operationalising “agricultural innovation systems” thinking, and in particular the need for interactions among a diversity of stakeholders. The influence of fashion in the donor agenda is nothing new: similar fads in the past included such respectable approaches as Farming Systems Research and a flurry of participatory approaches to technology development which all contributed to the emergence of AIS concepts and approaches (World Bank, 2006; Triomphe & Rajalahti, 2013). Copying success stories can be justified if these contribute to social learning and reflection, and if copying them allows concerned actors to put into use and internalise the best available knowledge and practices. Also, promoting and disseminating something that has been proven to work elsewhere may reduce the risk that the implementers “do the wrong thing”. Following the “bright lights” might thus help to capitalise on experience elsewhere, to empower implementing bodies and to develop their credentials and legitimacy to receive resources down the road. However, it is crucial that sufficient attention is given to understanding the local context and environment and if necessary carefully adapting the idea – even re-inventing and re-experimenting (which may require out-of-the-box thinking) – according to the specific local conditions and capacities of the involved actors. Clear examples of innovation success might be an opportunity to influence academic curricula and extension services towards innovation thinking and experimentation on a larger scale. MBA and PPP approaches are now being used by a host of projects in attempts to accelerate economic development in the agricultural sector and beyond. The market-based development being pursued today frequently involves a pragmatic and bottom-up approach focused on replicating and adapting what has worked well elsewhere.

However, replicating and upscaling the success of given experiences and approaches such as MBA, PPP, IPs or AIS bring a number of challenges. This can, for example, result in innovation being defined rather too narrowly as that which is driven by the market and involves public-private partnership (PPP), at the expense of other types of innovations and innovation triggers and drivers. Furthermore, it is increasingly being recognised that markets on their own do not necessarily and automatically solve the problems of food insecurity and poverty and, even when market liberalisation is accompanied by economic growth, this is not necessarily pro-poor (see also JOLISAA results in these proceedings: Triomphe *et al.*, 2014). With respect to IPs, there is a real danger that, under the influence of donors too obsessed perhaps with coming up with the silver-bullet approach to “simple” operationalisation of the AIS multi-stakeholder dimension, they are rolled out with little thought about how they enhance concretely the proper functioning of innovation systems and contribute to achieving longer-term development objectives, and about whether they may simply become the latest method for pursuing old-fashioned technology transfer in a more participatory fashion, with all its known limitations.

¹⁹ Original text developed by Luis Rodriguez (CSIRO)

Generally speaking, enthusiasm for replicating “success stories” and approaches such as MBA, PPP or IP is often based on little robust evidence to inform new investment decisions and to structure debate and learning. There is, in effect, a strong bias among donors and the research and development community towards reporting only or mostly on positive results, one-off findings and colourful narratives. They know, or report, very little about cases in which the same approaches proved ineffective. Hence, effective and critical learning about the actual potential of MBA and PPP and similar “bright lights” may be limited.

Another related challenge is the problems of parachuting in external interventions (see Issue 1). There is, in effect, a danger that the “bright lights” blind the well-meaning outsiders from seeing what is actually already happening locally. The aloe case assessed under JOLISAA provides an excellent illustration of this danger: an attempt to create a new certified aloe value chain “out of the blue” without giving attention to the existing dynamics of the aloe value chain in place (Chengole *et al* 2013).

4. *Surf the wave?*

Balancing more directed and output-driven innovation projects with more opportunistic outcome-oriented innovation processes²⁰

Agricultural innovation systems are complex, with multiple interactions between actors and institutions (e.g. policies, support schemes). For innovators and those who support them, it is important to be able to navigate this system, in order to acquire the necessary resources to support their innovations. They should therefore be capable of “surfing the seas of innovation” and be able to jump on the right waves in order to achieve the best ride possible. This applies also to “interventionists” in innovation projects, who may need to surf endogenous innovation processes, as described above, as well as surfing the “flavours of the year”. This will enable them to take advantage of changing donor priorities in ways that support existing innovation dynamics. For system change, the waves of innovation should have sufficient force to wash away existing, non-sustainable and non-equitable agricultural production, trading and marketing systems.

Promising approaches were identified during the AISA workshop that can enable smallholders and other stakeholders to surf the seas of innovation. These included:

- Farmer-managed and farmer-driven innovation funds to strengthen local innovation and initiatives. An example of this is the work currently developed within the PROLINNOVA international network (Waters-Bayer *et al* 2009, Macoloo *et al* 2014 in these proceedings), where smallholders can access direct funding to develop their own ideas and, if they wish, get support from different external stakeholders (NGOs, universities, researchers, extension) for receiving technical advice and developing links to other stakeholders, including other farmers and policymakers. This financial support allows joint learning and experimentation throughout the the innovation process. Other examples are approaches that put smallholder farmers at the centre of research priority-setting schemes (see e.g. Heemskerk *et al* 2003, Pimbert *et al* 2010) so that the farmers can (co-)drive the research agenda of scientific institutes.
- Programmatic approaches (having a coherent set of projects with a longer time horizon) rather than project approaches (single issue focus, short time horizon) may be a more effective way of supporting innovation over the long -term. Innovation usually goes beyond the scope and timeframe of one project (as documented by JOLISAA: see Triomphe *et al* and Floquet *et al* in these proceedings, for example); it is essential to create a longer-term programmatic approach in which several projects learn from each

²⁰ Original text developed by Laurens Klerkx (WUR)

other and create a critical mass to enable change, i.e. a forceful wave. An example is the CoS–SIS programme with different connected projects and innovation platforms (Jiggins 2012, Nederlof & Pyburn 2012, Adjei-Nsiah *et al* 2013).

However, while good examples already exist, several questions remain for further research and learning over the coming years:

- Relationships between innovation processes and higher-level structures (beyond farm level) are important. How do different innovation projects and interventions (particularly those operating at local levels) establish higher-level structural change? How can synergies between different innovation processes be achieved in order to create a stronger wave of change, by joint lobbying, joint experimentation etc.?
- How to move from optimising current systems to structural change? From calm sea to tsunami of creative destruction? Currently, innovation is sometimes (justifiably) aimed at problem solving, but does that provide all needed “real” longer-term solutions?
- How to maintain momentum within, and in -between, projects in terms of energy and creativity? How do “innovation champions” manage to jump from one project and development conundrum to another, while maintaining continuity in the innovation process? As this is at the very heart of the idea of surfing, understanding these processes and gaining some tips (through hints rather than capsizing) may help other potential innovation champions.

5. *Brain gain?*

Strengthening capacities to innovate and to facilitate innovation processes²¹

Developing a well-functioning innovation system requires strengthening the capacity of actors and institutions at the individual, household, organisational and system level. The importance of continuous investment and a long-term perspective toward capacity strengthening cannot be overemphasised.

Capacity development within the innovation system has to be considered from the perspective of end-users – farmers and, more specifically, smallholders – although this also has to be linked to other levels that may concern them or impact upon them. As knowledge is for a significant part context-specific, a common experiential background is needed to use it. During the workshop, it became clear that smallholder farmers are not only recipients and reproducers but also creative managers and integrators of knowledge and information from numerous sources, including their own practical experience and that of their peers. However, farmers differ in their individual capacities in agriculture-related communication and learning: in defining problems and information needs; in acquiring, selecting and processing information; in validating different sources of information and in storing, retrieving and exchanging it; and in their ability to draw relevant conclusions and lessons from the information and to incorporate these into their rationality. This latter is firmly rooted in personal experiences, efforts, reflection and learning in everyday life. Support for individual knowledge management requires recognition of the differential effect of various styles of agricultural management and of different communication patterns, while providing opportunities for individual improvement of skills.

In order for farmers to gain direct benefits from innovation processes, individual farmers’ capacities need to be strengthened in various dimensions, including thematic skills (e.g. their skills in dealing with a pest issue, or with natural resource management, or with accessing markets for example), organisational skills (e.g. group management and dynamics; leadership and advocacy) and basic business skills (e.g. setting and operating internal savings and

²¹ Original text developed by Silvia Sarapura (World Fish)

lending mechanisms, collective marketing, understanding and accessing markets, negotiation with input providers and produce buyers). It also involves the ability to access, adapt, share and apply new knowledge and technologies to manage their resources. Capacity is also required to enable actors to forge partnerships and create networks, profit-sharing arrangements and other collaboration between private- and public-sector actors. All such skills will eventually increase farmers' ability to participate in the AIS, influence its functioning and benefit from it as they see fit.

In addition to building capacities at the level of individual farmers and their organisations, attention also needs to be given to the competencies and skills of actors at higher levels in the AIS. This is important in order to address the range of technological, organisational, institutional and policy problems that affect smallholders in developing countries (Asenso-Okyere *et al* 2009). Strengthening capacities at higher levels can contribute to creating a favourable environment for developing the individual and collective capacities of farmers. Appropriate policies and government action can encourage actors in the AIS to create, accumulate, share and use knowledge; they can spur these actors to innovate, whereas inappropriate policies can discourage innovation (Hall *et al* 2007). Institutional capacity is also needed to identify, accommodate and facilitate innovation processes (Hall *et al* 2006).

Creating a culture of innovation should include strengthening the capacities of other actors to recognise the existing capacities and initiatives of farmers and encouraging other actors within the system to interact with farmers in a manner that facilitates knowledge flow (see Issue 1). Capacity development in agricultural innovation needs to support the integration of the indigenous knowledge and creativity of smallholder farmers in the AIS (see also Issue 2).

Innovation capacity entails more than technological artefacts, or the expertise and information within research organisations required to produce them (Klerkx *et al* 2009). The capacity for innovation also includes the process through which research-based knowledge and context-specific knowledge are combined to develop solutions that actually work in specific contexts. Innovation capacity includes a system or network of multiple actors with different areas of expertise. Users of new products and services, such as farmers and consumers, are therefore prominent actors in their own right. These systems are often informal, adaptive and transient, and are characterised by the context in which they emerge. The emergence and functioning of the networks of interaction that give rise to innovation are usually unplanned and spontaneous. However, if these processes are strengthened, better linked to formal research and directed toward developmental goals, innovation and impact will be greatly enhanced (Leeuwen *et al* 2007).

Individual and organisational **learning capacity** is closely linked to innovation capacity (Alegre & Chiva, 2008). Learning capacity includes five dimensions essential for knowledge production, application and sharing: i) experimentation: degree to which new ideas and suggestions are embraced; ii) risk taking: tolerance of ambiguity, uncertainty and errors; iii) interaction with the external environment: scope of relationships with the external environment; iv) dialogue: sustained collective inquiry for building common understanding; and v) participatory decision-making: level of influence actors have in the decision-making process. The relationships that sustain the acquisition of knowledge and permit interactive, sometimes referred to as social learning (Röling 2002; Wals 2007) are critical and can take many forms. They can be partnerships, e.g. in which two or more organisations pool knowledge and resources and jointly develop a product. Or they can be commercial transactions, in which an organisation purchases technologies or knowledge services from another organisation. Linkages may also take the form of networks, which provide an organisation with market and other early-warning intelligence on changing consumer preferences or technology. Networks also embody the “know who” of knowledge sources that can be tapped as the need arises.

Lundvall *et al* (1992) regard learning and the role of institutions as the critical components of innovation systems. Features of successful innovation systems identified by social scientists include, among others, continuous evolutionary cycles of learning and innovation (Hall *et al* 2001). Learning processes are vital in engendering a sense of ownership, particularly in terms of collective learning and interaction between researchers and other stakeholder groups. Development practitioners and community members may have different perspectives on learning than researchers have. The effectiveness of interaction between these groups depends on sharing knowledge around agreed common interests (Thiele 1999). Where differences in the agenda of communities and researchers exist but are not made explicit, there is a risk of misunderstanding, inefficient use of people's time, or even conflict (Baalen *et al* 2005).

There has been debate among scholars with regard to the level (individual, group or wider social) at which learning takes place and how it should be analysed and enhanced. A consensus exists that learning is the key driver in constructing new knowledge, competence and skills, while altering ways of thinking, ways of seeing, belief systems and routines. As is the case for knowledge (Latour, 1987), learning is also contextual with regard to actors actively and deliberately engaging in a learning process to develop knowledge pertinent to their specific circumstances (Jasper & Stuiver 2005). An active joint or social learning process not only empowers and challenges both researchers, farmers and other involved stakeholders to extend their knowledge and action into new areas (Hagmann *et al* 1999) but also promotes more vibrant and diverse innovation processes and outcomes.

Finally, strong capacity for communication, understood as a process of social interaction with the aim of mediating between different stakeholders and establishing common rules, also, plays a significant role within the AIS. Effective communication, access and distribution of information and knowledge all contribute to strengthening social capital, creating spaces for common action and facilitating knowledge management and sharing and innovation along the system. Capacity creation takes place not only through learning, but also through the social capital that exists within social networks and the ability to establish effective relationships (Shambu Prasad *et al* 2006).

In conclusion, the AIS framework and approach helps put the focus on the need to develop the capacity of individuals and organisations to learn, change and innovate, on the nature of iterative and interactive learning processes taking place among innovation agents, and on the types of interventions that enhance such capacities and processes. AIS should, however, be considered as one approach rather than as the only "must-use" one to creating policy and institutional conditions that will allow the emergence, coexistence and evaluation of diverse ways of creating, accumulating and utilising knowledge for agricultural growth (Biggs 1990), thus leading to social learning.

6. Suspended motion?

Monitoring, evaluating, adjusting, learning and reflecting on innovation results, outcomes and impacts²²

Actors involved in innovation processes (farmers, advisors, researchers, policymakers etc.) need to have access to relevant information to assess their situation and make informed decisions about the way forward. There are different mechanisms to provide such information:

- **Monitoring** is useful to all actors to strategically navigate in a complex system (see Issue 4) or situation and to adjust their actions quickly. Monitoring focuses more on the process

²² Original text developed by Guy Faure (CIRAD)

- and results of actions (e.g. number of people trained during a workshop).
- **Evaluation** is aimed at collectively assessing a set of actions usually at the end of a project (phase) and learning about innovation processes. The evaluation focuses more on the outcomes of actions (e.g. number of empowered farmer organisations).
 - **Impact assessment** is aimed at obtaining evidence about the “final” efficiency and efficacy of actions, comparing different innovation processes under different contexts, or justifying public or private investments in different sectors. Impact assessment focuses more on what happened after the end of a project (intervention). Impact assessment usually comes in response to a request made by donors or policymakers rather than by actors directly involved in innovation processes.

Different approaches, methods and tools can be used to characterise the results, outcomes and impacts of an innovation process or initiative:

- *Conventional quantitative measures* based on statistical methods are not necessarily to be trusted because of the difficulty to characterise some types of effect or impact (on food security, health, capacity etc) and to sample adequately (with and without innovation, before and after innovation). Furthermore, they are not necessarily relevant to understand the complexity of the innovation processes implying multiple interactions between actors, multiple loops along the process and a large variety of outcomes and impacts (desired and undesired, direct and indirect etc.).
- The international agricultural research centres use the “*impact pathway*” approach (e.g. Douthwaite et al. 2003) to take into account the complexity of innovation processes and to try and identify the contribution of research in the innovation process. While this represents significant methodological progress, it focuses on the specific role of one actor only (research), relies on hypothesised causal relationship (action A provokes results B) and struggles to take into account the uncertainty and the loops occurring during the innovation process.
- Both JOLISAA and CoS–SIS (Triomphe et al. 2014, Adjei-Siah et al. 2014, these proceedings) chose to rely on cross-analysis of multiple case studies to be able to analyse innovation processes. Such an option is not easy because there is a need to provide information on the choices made: What is the analytical framework used to analyse the innovation? What are the hypotheses? How to select the cases and justify the selection? How to rigorously draw out lessons?

The AISA workshop participants discussed some tricky questions about methods to assess innovation processes:

- Which is the relevant level of analysis (local versus more global)? Which is the relevant timeline? Depending on the choices made, the conclusions that are reached about the innovation process could change. For example, an assessment conducted at the end of a project may conclude that results were poor but, later on, actions implemented within the framework of the project may generate important changes in the area, in other areas or in other arenas.
- Which are the relevant criteria or indicators to assess the outcomes? Who selects these criteria or indicators? For example, change in yield could be regarded as a relevant criterion by researchers working on a new variety but could be irrelevant for farmers looking for better resistance to stress. Selection of criteria needs negotiation among actors.
- How to implement a monitoring system? An option is to ask an organisation dedicated to this function to take charge of M&E to ensure efficiency or at least to make more coherent choices but with a risk of concentration of information. Another alternative is to distribute the M&E tasks among stakeholders in a decentralised system, allowing a stronger involvement of the various stakeholders in the (re)collection of data, processing of information and sharing of results. But there still remains the question of sustainability

- of the monitoring system, raising the issues of skills, funds but also institutions.
- What are the conditions for an efficient use of a monitoring system? Does the monitoring system provide intermediary results on time to be able to influence the process? Do the actors managing the monitoring system organise continuous and iterative reflection between actors to generate an effective individual and collective learning process? Beyond the use of information by actors involved in the innovation system, participants highlighted the need to use a monitoring system to influence donors and policymakers and to convince them of the relevance of the AIS perspective. In this case, we need to be less naïve, to be aware of power relationships (e.g. some stakeholders may want to prevent some actors from supporting local innovation) and to identify the right channel to communicate (e.g. farmer organisations may be more legitimate to influence policymakers). We must learn to be more efficient in lobbying.

7. *The ripple effect?*

Outscaling, upscaling ...²³

This section focuses on how to move beyond “island of successes” to supporting many more people in a society; how to reach impact at scale, while still being faithful to the main principles of the AIS perspective (i.e. combining different sources of knowledge, fostering joint work and interaction, etc.).

There are largely two ways of looking at mechanisms to achieve impact at scale. The first is to look for ways in which innovations (here purposefully with an “s”) can be replicated, adapted and adopted by many other smallholder farmers or other actors in the value chain. This we refer to as *scaling out* (Uvin & Miller 1996). The second way to aim at reaching scale is to change the way organisations work, incorporating a new approach into their day-to-day activities, policy and working culture. This can imply, for example, changing the way agricultural research organisations deal with partners or the way governments operationalise the AIS principles in their extension programs. This we refer to as *institutionalisation*.

Scaling out

We depart from the principle that innovation is always a unique, context-specific process of learning, exchange and change in practice. This implies that its outcomes (innovations) are also context-specific. But that does not mean that what has been proved to work in one place cannot generate important lessons that we need to learn from, spread and put into use. Undoubtedly, there are innovations out there which are worth being tried out and brought to farmers and other actors in many parts of the world so that they can further experiment and “play” with them. Think for example of drip-irrigation systems, conservation agriculture, biological methods of pest control, positive selection in potato crops, weather/crop insurance and saving and credit cooperatives and – why not – innovation platforms.

What is needed is not, however, simply transferring innovations from one context to another, without properly taking into account the realities the “target” local people live in, as this may lead to failures and other unintended negative impacts. Rather, using such innovations somewhere else requires a process of re-adaptation (re-invention) to that (other) context, by building on pre-existing ideas and practice already validated in their place of origin.

Facilitating this re-adaptation process requires attention to several issues. A key guiding principle is to leave room for – and purposefully provide support to – both critical assessment and local adaptation by the key actors of the “external” innovation proposed for outscaling/re-adaptation. Is the specific, proposed drip-irrigation technology going to work locally,

²³ Original text developed by Mariana Wongtschowski (KIT)

under all circumstances? Most probably not. So extensionists, researchers and farmers need to (again) experiment to see what works well where. In doing so, they need to adopt a broad socio-economic perspective allowing them to address issues such as costs, labour, gender, equity or access. Researchers, for their part, may learn from this adaptation process to improve their own work, e.g. they may add a new criterion for improving or assessing the performance of the drip-irrigation system.

As the innovation becomes more widespread, the process of experimentation and local adaptation is likely to become easier. It is both impossible and unnecessary for researchers to accompany all those rounds of experimentation – extensionists, farmers and other actors/service-providers in the value chain can take over that process. But a feedback system should be in place so that the results and outcomes of such processes come back to the researchers. All this works only if there are – at local level – enough individuals/organisations with capacity to facilitate this process of experimentation. Scaling-out needs to go hand-in-hand with promoting and nurturing of soft and hard skills at local level (see Issue 5).

Institutionalisation

There are several ways one could change the manner an agricultural innovation system, or part of it, works. Change can result from directly involving colleagues and partners in the work. For instance, researchers working through/with innovation platforms could explain to other colleagues how this has changed her/his work and invite these colleagues to participate. Extensionists could invite their line manager to join a field day and come see with his/her own eyes what a process of building on farmers' own ideas has led to. Research and extension are, in that sense, critical vehicles for “carrying the message on” by incorporating some of it on their own way of working.

The way an organisation works can also be influenced by sharing information within and beyond the organisation, e.g. through publications, radio, announcement boards, mobile phones or social networks. Of particular importance here is what is to be shared: the proper documentation and collection of evidence of what has worked well – and what hasn't – under what circumstances. This does not require a complicated monitoring and evaluation system, but rather a sound system of data collection and joint analysis by those involved (see Issue 6). Evidence is key to inform and convince policymakers and high-level management. Change in policy then needs to be translated into practice, which – once more – demands a certain level of capacity and willingness at different levels (management, field).

Changing the way an organisation (or innovation system) works therefore hinges on what kind of professionals are “out there”. Building the capacity of a new generation of professionals to be more open to look for new ideas and work with other stakeholders is fundamental in a process that is long-term by nature (see Issue 5).

Spielman & Grebmer (2006) call for a reform in agricultural education and training in Africa in order to strengthen the innovative capabilities of agricultural organisations and professionals. They suggest “promoting new educational programs that are more strategically attuned to the different needs of society; inducing change in the cultures of education organisations (...); and strengthening individual and organisational capacity by improving the incentives to forge stronger linkages between agricultural education and training and diverse user communities, knowledge sources, and private industry”. Such a process of reform needs to include curriculum change: towards a curriculum that brings students closer to the realities “beyond the university walls”, is more practice-based and which has a better balance between soft and hard skills (Ochola *et al* 2013).

Risks of out- and upscaling

Scaling-out and institutionalisation carry with them a common risk. Concepts, ideas and processes tend to be too quickly “simplified” and standardised and often corrupted. One just

has to look at the work on innovation platforms. Once an avant-garde mechanism for supporting systematic interaction between stakeholders, it has mushroomed in recent years. A number of those platforms are still faithful to the original principles of tackling institutional constraints, joint experimentation and decision-making. Others have been used to disseminate technologies and practices, with little room for further experimentation and joint learning.

How to maintain the quality of the work done at scale remains an important question to address. Capacity building is a possible way to handle this. Other possible ways include appropriate monitoring systems and adequate rewarding/incentive policies.

Upscaling the capacity to innovate at system level

To achieve both meaningful and responsible scaling-out of innovations and to change the way organisations work in practice, individual, organisational and institutional (policy, behaviour) capacities are needed to find out new things to try, to carry out experiments, to learn and to bring new ideas into routine use (through further experimentation) (see also Issue 5). This broad “capacity to innovate” involves a combination of: i) scientific, entrepreneurial, managerial and other soft and hard skills and knowledge; ii) partnerships, alliances and networks linking different sources of knowledge; iii) routines, organisational culture and practices that allow for trying new things out with others; iv) ability to learn continuously and use knowledge effectively; and v) supportive policies and governance structures (Hall & Dijkman 2006).

At system level, addressing the following issues is important when planning interventions, so as to ensure that sufficient capacity to innovate at system level is in place:

- *Strong linkages between actors* – research, extension, education, farmers (organisations), NGOs, traders, processors and consumers. This may demand structural changes in the way research and extension define their working mode and priorities (by bringing those closer to local needs);
- *Understanding and building on the added value of each of these actors*. Research, like other actors, is a specific “service provider” to the innovation system. Research is therefore not the only or most important sources of new ideas and ways of doing things; it plays a supportive role in the process;
- *Better coordination and collaboration between research and extension*. This demands changes in the way research and extension – for example – relate to each other and are organised.

When planning to work within agricultural innovation systems, it is important to develop strategies to ensure that the principles of partnership and respect for each other’s knowledge and capacities are institutionalised within all organisations involved. This will increase the likelihood that not only existing promising innovations but also the processes of innovation will be outscaled in an equitable way.

Conclusions

As illustrated by this paper, the participatory Living Keynote process led AISA workshop participants to come up with a rich collective expertise on key topics related to enhancing innovations, which should be relevant to academic researchers, practitioners, policy-makers and donors. This includes making sense of and building on local innovation dynamics and stakeholders before and during external interventions; learning critically from, copying and building on past successes to replicate good ideas and approaches (such as market-based approaches, public-private partnerships or innovation platforms) without being blinded by their being the latest fad; surfing the complexities and discontinuities of innovation systems and situations; developing among stakeholders and at a various levels a capacity to innovate

in its various dimensions; learning from and assessing reflexively past and on-going innovation processes and their corresponding effects, outcomes and impacts; and finally out-scaling and institutionalising innovations and innovation processes.

Because of the short duration of the AISA workshop, and the necessity to focus on a limited number of issues, other relevant issues and strategic questions were not addressed in the workshop and in this paper: to do so would have required a more thorough access to, and review of, the already vast academic and grey literature and experiences fast accumulating on such issues, something beyond the reach of this exercise.

Our hope is, however, that – despite their obvious limitations –, these results may give food for thought to the members of the emerging AIS community of practice, and particularly to those involved in fostering innovation involving African smallholders. We also hope that other workshop and event organisers will want to further experiment with and refine the proposed Living Keynote process, as a way of making sense of and building on the collective expertise and wisdom of participants willing to engage in well-facilitated and free-flowing interchange of experiences.

References

- Adjei-Nsiah S, Sakyi-Dawson O & Klerkx L. 2013. Facilitating institutional change in West Africa: the CoS-SIS experience. In: Triomphe B et al. (eds), *Innovation in smallholder farming in Africa: recent advances and recommendations* (Montpellier: CIRAD), pp 20–26.
- Alegre J & Chiva R. 2008. Assessing the impact of organizational learning capability on product innovation performance: an empirical test. *Technovation* 28: 315–326.
- Asenso-Okyere K, Workneh S, Rhodes E & Sutherland J. 2009. Rebuilding after emergency: revamping agricultural research in Sierra Leone after civil war. IFPRI Discussion Paper 869. Washington DC: International Food Policy Research Institute.
- Baalen P van, Bloemhof-Ruwaard J & Heck E van. 2005. Knowledge sharing in an emerging network of practice: the role of a knowledge portal. *European Management Journal* 23: 300–314.
- Biggs SD. 1990. A multiple source of innovation model of agricultural research and technology promotion. *World Development* 18 (11): 1481–1499.
- Chengole JM, Welimo M, Belmin R, Kamau G, Ng'ang'a T & Triomphe B. 2014. Experiences with aloe domestication and exploitation, Baringo County, Kenya. In: Triomphe B, et al (eds), *Innovation in smallholder farming in Africa: recent advances and recommendations* (Montpellier: CIRAD), pp 71–74.
- Douthwaite, B, Kuby T, van de Fliert E & Schulz S. 2003. Impact pathway evaluation: an approach for achieving and attributing impact in complex systems. *Agricultural Systems*, 78 (2): 243265.
- Floquet A., Vodouhê, G., Michaud, A., Bridier, B &., and Vodouhê, S.D. 2014. How innovation processes unfold along unexpected trajectories –: the case of Soy in Benin. In: Triomphe B. et al. (eds.), *Innovation in smallholder farming in Africa: recent advances and recommendations*. (Montpellier, CIRAD), pp 104-108
- Hagmann J, Chuma E, Murwira K & Connolly M. 1999. Putting process into practice: operationalizing participatory extension. *Agricultural Research and Extension Network Paper* 94. London: Overseas Development Institute.
- Hall A, Bockett G, Taylor S, Sivamohan MA & Clark N. 2001. Why research partnerships really matter: innovation theory, institutional arrangements and implications for developing new technology for the poor. *World Development* 29 (5): 783–797.
- Hall A & Dijkman J. 2006. Capacity development for agricultural biotechnology in developing countries: concepts, contexts, case studies and operational challenges of a systems perspective. UNU-MERIT Working Paper #2006-003. Maastricht: UNU-MERIT.
- Hall A, Janssen W, Pehu E & Rajalhati R. 2006. *Enhancing agricultural innovation: how to go beyond the strengthening of research systems*. Washington DC: World Bank.

- Hall A, Clark N & Naik G. 2007b. Institutional change and innovation capacity: contrasting experiences of promoting small-scale irrigation technology in South Asia. *International Journal of Technology Management and Sustainable Development* 6 (92): 77–101.
- Heemskerk W, Lema N, Guindo D, Schouten C, Semgalawe Z, Verkuijl H, Steenhuijsen Piters B De & Penninkhoff P. 2003. *A guide to demand-driven agricultural research: the Client-oriented Research Management Approach*. Amsterdam: KIT Publishers.
- Jasper E & Stuijver M. 2005. Learning in context through conflict and alignment: farmers and scientists in search of sustainable agriculture. *Agriculture and Human Values* 22: 137–148.
- Jiggins J. 2012. Diagnosing the scope for innovation: linking smallholder practices and institutional context. *Wageningen Journal of Life Sciences* 60–63: 1–8 (www.journals.elsevier.com/njas-wageningen-journal-of-life-sciences/recent-articles).
- Klerkx L, Hall A & Leeuwis C. 2009. Strengthening agricultural innovation capacity: are innovation brokers the answer? *International Journal of Agricultural Resources, Governance and Ecology* 8: 409–438.
- Latour B. 1987. *Science in action: how to follow scientists and engineers through society*. Cambridge: Harvard University Press.
- Leeuwen A van, Beekmans A & van Haeringen R. 2007. Knowledge management to connect and strengthen people's capacities in Latin America. *Knowledge Management for Development Journal* 3 (2): 85–94.
- Lundvall BA, Vang J, Joseph K & Chaminade C. 2009. Bridging innovation research and development studies: challenges and research opportunities 7th Globelics Conference, Senegal.
- Macooloo C, Kamau G, Makonge R, Ng'ang'a T, Waters-Bayer A & Veldhuizen L van. 2014. Farmer-managed funds stimulate farmer-led participatory innovation processes. In: Triomphe B et al (eds), *Innovation in smallholder farming in Africa: recent advances and recommendations* (Montpellier: CIRAD), pp 26–36.
- Nederlof ES & Pyburn R (eds). 2012. *One finger cannot lift a rock: facilitating innovation platforms to trigger institutional change in West Africa*. Amsterdam: KIT Publishers.
- Ochola W, Heemskerk W & Wongtschowski M (eds). 2013. *Changing agricultural education from within: lessons and challenges from the GO4IT programme*. Kampala: RUFORUM / Amsterdam: KIT Publishers.
- Pimbert M, Barry B, Berson A & Tran-Thanh K. 2010. *Democratising agricultural research for food sovereignty in West Africa*. Bamako & London: International Institute for Environment and Development (IIED), Coordination Nationale des Organisations Paysannes du Mali (CNOP), Centre Djoliba, Institut de Recherche et de Promotion des Alternatives en Développement (IRPAD), Kene Conseils, Union des Radios et Télévisions libres du Mali (URTEL).
- Röling N. 2002. Issues and challenges for FFS: an introductory overview. International Learning Workshop on FFS: Emerging issues and challenges, 21–25 October 2002, Yogyakarta, Indonesia.
- Shambu Prasad C, Hall A & Thummuru L. 2006. Engaging scientists through institutional histories. ILAC Brief 14. Rome: ILAC.
- Sherwood SC, Schut M & Leeuwis C. 2012. Learning in the social wild: encounters between Farmer Field Schools and agricultural science and development in Ecuador. In: Ojha HR et al (eEds), *Adaptive collaborative approaches in natural resources governance: rethinking participation, learning and innovation* (London: Routledge), pp 102–137.
- Spielman DJ & Grebmer K von. 2006. Public-private partnerships in international agricultural research: an analysis of constraints. *Journal of Technology Transfer* 31 (2): 291–300.
- Sulaiman RV, Hall A & Reddy VTS. 2011. Missing the target: lessons from enabling innovation in South Asia. Wallingford, UK (www.dfid.gov.uk/r4d/PDF/Outputs/ResearchIntoUse/riu11discuss25asia.pdf).
- Thiele G. 1999. Informal potato seed systems in the Andes: why are they important and what should we do with them? *World Development* 27 (1): 83–99.
- Triomphe B. & Rajalahti R. 2013. From concept to emerging practice: what does an innovation system perspective bring to agricultural and rural development?. In : Coudel et al (eds), *Renewing innovation systems in agriculture and food*. (Wageningen Academic Publishers), 2013. pp. 5776.

- Triomphe, B., Floquet, A., Kamau, G., Letty, B., Vodouhê, D.S., N'gan'ga, T., Stevens, J., van den Berg, J., Sellamna, N., Bridier, B., Crane, T., Almekinders, C., Waters-Bayer, A., Oudwater, N. & Hocdé, H. 2013. What does an inventory of recent innovation experiences tell us about agricultural innovation in Africa? *Journal of Agricultural Education and Extension*. 19 (3): 311–324.
- Triomphe, B., Floquet, A., Kamau, G., Letty, B., Vodouhê, D.S., Stevens, J., van den Berg, J., Crane, T., Almekinders, C., Sellamna, N., Bridier, B., Oudwater, N. & Waters-Bayer, A. 2014. Multistakeholder innovation processes in African smallholder farming: key lessons and policy recommendations from Benin, Kenya and South Africa. In: B. Triomphe B *et al.* (eds.), *Innovation in small holder farming in Africa: recent advances and recommendations*. (Montpellier: CIRAD), pp. 4455.
- Uvin P & Miller D. 1996. Paths to scaling-up: alternative strategies for local nongovernmental organizations. *Human Organization* 55 (3): 344–354.
- Wals AEJ (ed.). 2007. *Social learning: towards a sustainable world*. Wageningen Academic Publishers.
- Waters-Bayer A, Veldhuizen L van, Wongtschowski M & Wettasinha C. 2009. Recognizing and enhancing processes of local innovation. In: Sanginga P, et al (eds), *Innovation Africa: enriching farmers livelihoods* (London: Earthscan), pp 239–254.
- World Bank, 2006. *Enhancing agricultural innovation: how to go beyond the strengthening of research systems*. World Bank, Washington DC.

CONCLUSIONS AND WAY FORWARD

The AISA workshop brought together about 100 people working in Africa and beyond to present in various forms their experiences in AIS. The workshop enabled participants to discuss these experiences in numerous different constellations and to draw out lessons not only for themselves but also for others wanting to promote and support innovation processes in smallholder agriculture. The workshop revealed that, since the concept of AIS was introduced into agricultural research and extension (Hall *et al* 2003, Leeuwis & Ban 2004, Hall *et al* 2005), considerable advances have been made in operationalising the concept – both in analysing and in strengthening innovation systems in agriculture. The workshop discussions, the highlights of which are captured in the Living Keynote (Section 5 of these proceedings), point to key implications of taking an AIS perspective in ARD. These fed into the formulation of the following lessons and recommendations for policy- and decision-makers seeking to enhance the capacities of smallholder farmers and other AIS actors in Africa to adapt to change, to improve rural livelihoods and to meet the growing food and nutrition needs on the continent.

The examples discussed during the workshop made it clear that simply introducing an “improved” technology does not automatically lead to innovation and desired change. New technology is only one of many inputs into an ongoing, collective, interactive and multi-faceted innovation process that involves continuous adaptation to new conditions so as to improve system productivity, food security, resilience and income. By acknowledging this reality and building on it, policy- and decision-makers, including donors, will be better able to foster a dynamic and enduring agricultural sector responding to the needs and wishes of African societies.

The key recommendations for strengthening innovation systems in smallholder agriculture in Africa can be summarised as follows (see also the JOLISAA policy brief: Waters-Bayer *et al.*, 2013).

Build on innovation “in the social wild”

With little or no support from public ARD institutions, many smallholders are actively innovating individually and collectively to solve problems, improve their farming and income, and grasp opportunities. African smallholder agriculture is dynamic. Farmers respond in many innovative ways to the rapid changes and global challenges they face, including market competition, increasing and conflicting demands on use and management of land and water, and increasing unpredictability of weather and markets. The workshop participants have documented numerous ongoing innovation processes that show the capacity of smallholder farmers to grasp opportunities, to create or access markets, to increase their resilience to risks and shocks, and to manage natural resources in a responsible and sustainable way.

Yet many such initiatives take place “under the radar” or “in the social wild” (Sherwood *et al.*, 2012) (or are ignored by state, non-state, private-sector and even national farmer organisations trying to develop and spread new technologies. Local innovation fitting the wide variety of contexts of African agriculture needs to be better recognised, valued and encouraged. If this is achieved, it will enhance the potential of African smallholders and enable them to work together with formal ARD actors in designing and expanding more productive, more profitable and more sustainable farming and food systems.

Formal ARD actors provide important elements, such as new knowledge and technologies, external inputs and other stimuli for innovation, but farmers and other stakeholders operating in “real world” contexts may be better placed to identify key constraints and opportunities for

innovation. They are also the ones who decide if and how to use and adapt the inputs from ARD to their own context, so that innovation takes root and succeeds.

External interventions can play an important role in initiating and supporting innovation, but should avoid creating artificial “enabling” conditions and incentives (including market outlets) that do not fit with local realities and are short-lived and unsustainable. Such interventions may easily undermine existing innovation dynamics and can seldom drive innovation over the longer term, unless change also takes place in the policy and institutional environment during the period of the intervention.

Interventions should start with a thorough joint assessment, involving local actors, of ongoing innovation processes in the area. This should include the identification of initiatives that should be supported, rather than ignoring or trying to bypass them. Such an assessment should result in a more detailed understanding of local dynamics, so that interventions can be devised which both “surf the wave of what is happening” and build on local initiatives.

Combine local and external knowledge and ideas to enhance innovative capacity

Linking multiple sources of knowledge can enhance the capacity of all stakeholders to innovate, to adapt to changing conditions and to grasp opportunities. Although innovation processes occurring “in the social wild” are dynamic, they can be strengthened, sped up and made more sustainable through appropriate inputs of knowledge of different types and from different sources, responding to farmers’ demands, needs and actual possibilities. Combining local and external knowledge and resources is necessary to meet the challenges faced by today’s and tomorrow’s agriculture. It is not, however, a simple matter of parachuting in (or transferring) “scientific” technologies from elsewhere. Linking the knowledge and ideas of smallholders, small and medium-sized entrepreneurs and local government with external knowledge and ideas leads to an improved capacity and potential of all involved to address ongoing or emerging challenges and opportunities and, in doing so, contribute to improving food security, productivity, incomes and livelihoods. Communication and sharing has to be enhanced at different levels, using a range of approaches and methods, e.g. consortia, innovation platforms, fairs etc.

Support unpredictable innovation processes

Innovation does not happen in a linear way and it cannot be planned from the outset of an intervention. Innovation pathways take new and unpredictable directions over many years or even decades as they unfold within and mostly outside the framework of external interventions, they are context-specific and the context is constantly changing.

Any attempt to foster innovation processes through intervention should expect and recognise such unexpected deviations. This will require putting less emphasis on rigid pre-planned prescriptions about what to do and to be open to adjust priorities, approaches and modalities of support along the way in an iterative and flexible manner, reflecting the changing dynamics and opportunities. Space needs to be given for a process-oriented approach rather than seeking outcomes narrowly defined at the outset. Interventions can start by assuming a realistic path and designing mechanisms toward a desired outcome (such as increased productivity or emergence of a new value chain). However, all the people involved need to reflect frequently whether the assumed path is indeed being followed, what are the real drivers of change and what other initiatives and dynamics may be emerging that would benefit from support. Project activities then need to be adjusted accordingly. Wider institutional support needs to accommodate these dynamically unfolding processes, always keeping in sight the overall aim of improving the livelihoods of smallholders and other local

stakeholders and benefiting the rural and urban poor consumers. Research approaches and funding should accommodate such open-ended and flexible innovation processes.

Address the multiple dimensions of innovation

Beyond new technologies, innovation has important social and organisational dimensions that are closely intertwined and cannot be addressed in isolation from each other. Technologies are often seen as central to innovation and transferable from one context to another. But in practice, technologies are shaped by the people using them and by their social, economic and institutional contexts. Social and institutional change (new ways for farmers to organise themselves and access markets, new services, new approaches to supporting innovation, new rules and policies) is often needed so that new technologies can be fully integrated into local practices. Similarly, social or institutional change may come first and lead to technological innovation: e.g. helping farmers supply a new market may convey consumer demand for better or different products, which then requires farmers to change their production, processing and marketing practices. Encouraging the formation and strengthening the capacities of structures representing farmers (e.g. umbrella farmer associations, farmer fora) can make farmer groups better able to negotiate fair contracts or to provide technical advice or credit to their members.

Taking a holistic view of innovation by supporting its multiple dimensions gives a better chance of achieving outcomes more relevant for smallholder farmers and other local actors. Beside generating and transferring technology, support should hence go to enabling and accompanying organisational and institutional changes that make innovation possible and successful and may drive large-scale spread and adaptation of technology. ARD actors need relevant resources and skills to be able to take part in and support innovation processes that encompass these different dimensions. Governments and donors need to invest in long-term cross-sectoral budgets to provide such necessary support.

How to walk the talk?

Workshop participants were fully aware that the recommendations coming out of their deliberations are not brand new. Indeed, over recent years, the International Assessment of Agricultural Science, Knowledge and Technology for Development (IAASTD 2009) and the World Bank (2012) endorsed similar and complementary recommendations. However, government and other ARD actors still need to “walk the talk” and to act on these recommendations. This is essential in order to support agricultural innovation by and with smallholder farmers and other local stakeholders, and to recognise such multistakeholder processes as a key ingredient in achieving more equitable and sustainable development, better food security and a vibrant smallholder family-farming sector. Farmer organisations also have to be pro-active in monitoring innovation processes and raising issues that need attention from formal ARD. The workshop participants – both during the e-discussion leading up to the workshop and during the workshop itself – gave some suggestions on how to take action on these recommendations:

Convince governments and donors to change the way they fund interventions

A fundamental change must be made in the way projects are operated and funded. ARD actors should lobby actively for such change. Donors should develop specific guidelines under their portfolio of grant schemes for process-oriented proposals, designed in phases with periodic evaluation and re-approval, with budgets that explicitly accommodate the cost of a participatory, inclusive process, e.g. initial negotiation, joint reflection and M&E that can respond quickly to locally emerging needs and demands. Donors should acknowledge that

change requires support well beyond the typical 3–4 year project timespan up to ten years or more. This time is needed to deal with the numerous interlinked technical, organisational and institutional aspects of innovation that are critical for attaining widespread and lasting benefits for smallholders and other local actors.

Support innovation platforms and other multi-actor alliances at different levels

ARD institutions should provide support for creating, strengthening and working in alliances. Innovation platforms may need to be adapted to specific contexts and objectives and be able to operate at all appropriate levels, from local to national. Such alliances and platforms should involve, in a flexible and dynamic manner, not only formal ARD actors but also other relevant stakeholders, e.g. farmers and their organisations, entrepreneurs, government staff and NGOs. Providing “smart” and decentralised financial support to local alliances of stakeholders to strengthen their innovation capacity and initiatives is also critical, e.g. farmer-managed funds for local experimentation (Waters-Bayer *et al* 2011).

Develop innovation brokerage capacity

In a vibrant innovation process, all stakeholders express their needs and demands, formulate goals and visions, contribute their skills, and share their knowledge, resources and responsibilities with each other. Trained “brokers” can facilitate such interactions at key stages in the process. They can encourage joint reflection about constraints and opportunities and help clarify the roles of all involved. At different stages, different actors may play the brokerage role: NGO staff, advisors, farmer leaders, entrepreneurs, researchers etc. Sometimes, external facilitation may be best to mediate conflicts. Investment is needed in order to build brokerage capacities, and in some cases to fund the provision of trained brokers.

Strengthen pivotal role of agricultural advisors

Agricultural advisors are in a key position to be brokers of innovation processes and to provide a host of other support services to innovation initiatives of smallholders and local enterprises. However, they need to have an explicit mandate for playing such roles, while their capacities to do so need to be strengthened. Renewed investment in rural advisory services is needed, and institutional support for advisors to be able to play a brokerage role in innovation processes has to be firmly integrated at all levels in the advisory services.

Integrate innovation system approach in education and training

AIS approaches are key to understanding and enhancing innovation. Universities, colleges and vocational schools play a major role in preparing future and current researchers, rural advisors, farmer leaders and local government staff through initial and continuing education on AIS concepts and approaches. To build capacities in AIS, educational and training institutions need to interact closely on the ground with farmers, rural communities, entrepreneurs, advisors, researchers and government staff. Thus, students and teachers are exposed to existing innovation dynamics in smallholder farming, learn how to see and analyse the processes, contribute to documenting and understanding how agricultural innovation happens, and acquire the skills needed to support it.

The way ahead

The various programmes, projects and initiatives presented and discussed at the AISA workshop show that support to strengthen the innovation capacities of smallholder farmers and other local stakeholders may take several forms, depending on the local and national context and the objectives pursued. Many governments, donors, research and advisory services, educational institutions and private enterprises need to change the way they perceive and engage with smallholders and the way they design interventions. This is critical if innovation, in its intricate diversity and long-term character, is to take place and thrive for the benefit of smallholders, rural and urban consumers, and national economies.

The workshop participants highlighted key areas for change, and provided some specific suggestions about how things might be done better. It is now up to all of us to act on these recommendations to achieve a dynamic, innovative and productive smallholder family – farming sector – and to convince others to act likewise.

Cited references

- Hall A, Mytelka L & Oyeyinka B. 2005. Innovation systems: implications for agricultural policy and practice. ILAC Brief 2. Rome: ILAC.
- Hall A, Sulaiman RV, Clark NG & Yoganand B. 2003. From measuring impact to learning institutional lessons: an innovation systems perspective on improving the management of international agricultural research. *Agricultural Systems* 78: 213–241.
- IAASTD. 2009. *Agriculture at a crossroads: international assessment of agricultural knowledge, science and technology for development: global report*. Washington DC: IAASTD.
- Leeuwis C & Ban A van den. 2004. *Communication for rural innovation: rethinking agricultural extension*. Oxford: Blackwell Science.
- Sherwood SC, Schut M & Leeuwis C. 2012. Learning in the social wild: encounters between Farmer Field Schools and agricultural science and development in Ecuador. In: Ojha HR, Hall A & Sulaiman R (eds), *Adaptive collaborative approaches in natural resources governance: rethinking participation, learning and innovation* (London: Routledge), pp102–137.
- Waters-Bayer A *et al.* 2011. Farmer-managed innovation funds drive multi-stakeholder learning processes. In: CTA/GFRAS International Conference “Innovations in Extension and Advisory Services,” Nairobi, Kenya, pp15–18.
- Waters-Bayer, A, Triomphe, B & Oudwater, N (eds). 2013. Building on local dynamics: Five policy recommendations for enhancing innovation by African smallholder farmers., JOLISAA global policy brief. JOLISAA project, Montpellier (France), 6 pp.
- World Bank. 2012. *Agricultural innovation systems: an investment sourcebook*. Washington DC: World Bank.

Content

- Annex 1: AISA workshop agenda
- Annex 2: List of AISA workshop participants
- Annex 3: Expectations of participants
- Annex 4: Learning from farmer innovators at the Eastern African Farmer Innovation Fair
- Annex 5: Messages from farmer innovators to the AISA workshop participants
- Annex 6: Hot topics for the Living Keynote
- Annex 7: Poster marketplace and Open Space session
- Annex 8: Feedback given by workshop participants on the oral papers
- Annex 9: Notes from closing evaluation with the AISA workshop participants

Annex 1: AISA workshop agenda

Date / Time	Day 1: Wednesday 29 May 2013
14.00	Welcome and introduction
14.45	Learning visits (in working groups) to farmer innovator booths
16.15	Sharing feedback from visiting farmer innovator booths and mapping key insights from farmer innovators' experiences
18.00	Cocktail (organiser: CLIC–SR project)
	Day 2: Thursday 30 May 2013
09.00	Introduction to Living Keynote about agricultural innovation systems in Africa
11.00	Parallel sessions based on three experiences <ul style="list-style-type: none"> • Brief presentations, followed by group discussion: <ul style="list-style-type: none"> - JOLISAA presentation - PROLINNOVA presentation - CoS–SIS presentation
13.30	Parallel sessions based on three more experiences <ul style="list-style-type: none"> • Brief presentations, followed by group discussion: <ul style="list-style-type: none"> - FARA presentation - AusAID/CSIRO presentation - ILRI/CPWF Innovation Platform Writeshop
15.30	Plenary sharing feedback from group discussions, consolidation of insights for Living Keynote
18.00	Cocktail (organiser: AISA)
	Day 3: Friday 31 May 2013
09.00	Open exhibition of relevant experiences in smallholder agricultural innovation (Posters – see compilation of abstracts)
10.00	Open Space: exploring ideas, documenting conversations, suggesting actions and recommendations to apply and scale up innovation approaches
13.30	Policy synthesis dialogue preparation (groupwork): Preparing key policy messages and recommendations for different groups of stakeholders to stimulate agricultural innovation processes and systems in Africa: <ul style="list-style-type: none"> • e.g. donors, academia/teachers & learners (capacity development actors), farmer representatives, advisors, private-sector entrepreneurs, regulators & rule makers, local administrators
14.00	Plenary policy synthesis dialogue: <ul style="list-style-type: none"> • Interactive panel session on important issues, insights and ways forward • Response to the messages by representatives of present interest groups
15.30	Sharing the Living Keynote and finding ways forward
16.00	Concrete next steps, brief workshop evaluation, official closing

Annex 2: List of AISA workshop participants

<i>No.</i>	<i>Last name</i>	<i>First name</i>	<i>Sex</i>	<i>Institution</i>	<i>Country of residence</i>
1	Adekunle	Adewale	M	FARA	Ghana
2	Adjei-Nsiah	Samuel	M	CoS-SIS	Ghana
3	Almekinders	Conny	F	WUR	Netherlands
4	Atakos	Vivian	F	CCAFS	Kenya
5	Avornyoy	Franklin	M	CSIR-ARI	Ghana
6	Ballantyne	Peter	M	ILRI	Ethiopia
7	Bisht	Sonali	F	Institute of Himalayan Environmental Research and Education (INHERE)	India
8	Boogaard	Birgit	F	ILRI	Mozambique
9	Bolo	Maurice	M	Scinnovent	Kenya
10	Bourgou	Tsuamba	M	World Neighbors	Burkina Faso
11	Cadhilon	Jo	F	ILRI	Kenya
12	Carberry	Peter	M	AusAID	Australia
13	Chengole	Josephat	M	KARI	Kenya
14	Crane	Todd	M	WUR	Netherlands
15	Cullen	Beth	F	ILRI	Ethiopia
16	Dabire	Rémy	M	FiBL West Africa / Syprobio	Mali
17	Dror	Iddo	M	ILRI	Kenya
18	Duncan	Alan	M	ILRI	Ethiopia
19	Dusengemungu	Leonidas	M	RAB	Rwanda
20	Faure	Guy	M	CIRAD-UMR	France
21	Floquet	Anne	F	UAC-FSA	Benin
22	Foerch	Wiebke	F	CCAFS	Kenya
23	Gonsalves	Julian	M	PROLINNOVA	Philippines
24	Hall	Andy	M	LinK / UNU-MERIT	India
25	Hawkins	Richard	M	ICRA	Netherlands
26	Hitimana	Nicholas	M	RAB / Ikirezi Products	Rwanda
27	Jensen	Henning Høgh	M	Agrotech	Denmark
28	Kamau	Geoffrey	M	KARI	Kenya
29	Kavoi	Justus	M	KARI	Kenya
30	Kimenju	John	M	University of Nairobi	Kenya
31	Klerkx	Laurens	M	WUR	Netherlands
32	Kristjanson	Patti	F	CCAFS	Kenya
33	Kwashimbisa	Mendai	F	WorldFish	Zambia
34	Lançon	Jacques	M	CIRAD	Kenya
35	Le Borgne	Ewen	M	ILRI	Ethiopia
36	Legesse	Tesfaye	M	AusAID	Kenya
37	Lema	Zelalem	M	ILRI	Ethiopia
38	Letty	Brigid	F	Institute of Natural Resources	South Africa
39	Lohmann	Jörg	M	GIZ	Germany
40	Macoloo	Chris	M	World Neighbors	Kenya
41	Makini	Felister	F	KARI	Kenya

<i>No.</i>	<i>Last name</i>	<i>First name</i>	<i>Sex</i>	<i>Institution</i>	<i>Country of residence</i>
42	Manandhar	Suman	M	Local Initiatives for Biodiversity, Research and Development (LI-BIRD)	Nepal
43	Maute	Felisberto	M	ILRI	Mozambique
44	Mayanja	Sarah	F	CIP	Uganda
45	Mbabu	Adiel	M	CIP	Kenya
46	Mburathi	George	M	ACIAR	Kenya
47	McMillan	Larrelle	F	AusAID	Kenya
48	Meijboom	Marianne	F	INSARD/ETC Foundation	Netherlands
49	Miano	David	M	KARI	Kenya
50	Misiko	Michael	M	CIMMYT	Ethiopia
51	Mkondiwa	Maxwell	M	Lilongwe University	Malawi
52	Mongbo	Roch	M	UAC–FSA	Benin
53	Mose	George	M	United State International University (USIU)	Kenya
54	Mundy	Paul	M	Freelance	Germany
55	Mungai	Catherine	F	CCAFS	Kenya
56	Mwakoi	Dorcas	M	MoA	Kenya
57	Mwangi	Njuru	M	EU	Kenya
58	Mwangi	John J.	M	Egerton University	Kenya
59	Mwangi	Peter	M	KENFAP	Kenya
60	Nahdy	Silim	M	AFAAS	Uganda
61	Narvaez Mena	Horacio	M	WUR/ EkoRural	Ecuador
62	Ng'ang'a	Teresiah	F	PROLINNOVA–Kenya	Kenya
63	Ngwenya	Hlami	F	FANRPAN	South Africa
64	Nicolay	Gian	M	FiBL	Switzerland
65	Njoroge	Liston	M	Alliance for a Green Revolution in Africa (AGRA)	Kenya
66	Ogotu	Liz	F	AusAID	Kenya
67	Okello	Bell	M	ICRW / PROLINNOVA–Kenya	Kenya
68	Omari	Jane	F	National Council for Science & Technology	Kenya
69	Raboanarielina	Cara	F	AfricaRice	Benin
70	Radeny	Maren	F	CCAFS	Kenya
71	Recha	John	M	CCAFS	Kenya
72	Rodriguez	Luis	M	AusAID	Australia
73	Rootman	Gerrit	M	LPA	South Africa
74	Sanyang	Sidi	M	CORAF	Senegal
75	Sarapura	Silvia	F	WorldFish	Malaysia
76	Schut	Marc	M	WUR	Netherlands
77	Sellamna	Nour	M	ICRA	France
78	Somé	Hubert	M	SNV Netherlands Development Organisation	Burkina Faso
79	Stepman	François	M	PAEPARD	Belgium
80	Stevens	Joe	M	University of Pretoria	South Africa
81	Stone	Peter	M	AusAID	Australia

<i>No.</i>	<i>Last name</i>	<i>First name</i>	<i>Sex</i>	<i>Institution</i>	<i>Country of residence</i>
82	Swaans	Kees	M	ILRI	Ethiopia
83	Thiam	Djibril	M	Agrecol-Afrique	Senegal
84	Thornton	Philip	M	CCAFS	Kenya
85	Touzard	Jean-Marc	M	INRA	France
86	Triomphe	Bernard	M	CIRAD	France
87	Tucker	Josie	F	Overseas Development Institute	UK
88	van den Berg	Jolanda	F	WUR	Netherlands
89	van Rooyen	André	M	ICRISAT	Zimbabwe
90	Vodouhê	Simplice Davo	M	UAC-FSA	Benin
91	Walker	Daniel	M	AusAID	Australia
92	Waters-Bayer	Ann	F	PROLINNOVA/ETC Foundation	Netherlands/Germany
93	Wongtschowski	Mariana	F	Royal Tropical Institute (KIT)	Netherlands

Annex 3: Expectations of participants

As identified on 29 May 2013 during AISA opening at Eastern Africa Farmer Innovation Fair

Researchers:

- Learn and share
- Get a reality check
- Networking
- Strengthening a community of practice on these issues
- Understanding how to cross the disciplines in research
- How to benefit from the workshop to identify new research questions

NGOs and other development practitioners:

- Network and joint learning
- Better understand outcomes of innovation
- Understand what AISA does and how to collaborate
- Discover farmers' innovations
- Help with the dissemination of some of these innovations
- Understand how to interpret innovation at poverty level
- Find new ways to adapt or do new things (in Burkina Faso)

Decision-makers, consultants etc:

- Learn and share knowledge (x2)
- Networking
- Understand innovation systems in agriculture and what makes an operational innovation platform
- Stimulate information and networking
- Scaling up and commercialisation
- Understand how donors can support innovation
- See what are available innovations to partner with, to support etc
- Screen demand for innovation by producers, retailers, consumers
- Understand how to validate innovation and identify which could be scaled up
- Understand policy issues around innovation
- Identify skills and characteristics of organisations to support innovation
- Capacity development for farmers

Annex 4: Learning from farmer innovators at the Eastern African Farmer Innovation Fair

After visiting farmers' innovators booths during EAFIF, AISA workshop participants came up with the following insights about farmer innovation.

About the farmer innovators themselves

- They are experimenters in their own right (→ need to recognise and nurture farmer capacity to do research)
- There are very creative, inventive and courageous
- They are willing to share; they promote their innovations well
- Many of them seem to have had long experience outside their communities

Definition of innovation

- There is no agreement on what is an innovation. Is that important?

Knowledge sharing

- There needs to be strong collaboration between stakeholders
- There is ongoing collaboration with research/universities for many innovators
- Formal researchers need to work closely on following up on local innovations
- There is an apparent gap (lack of communication) between local and scientific knowledge
- How could local innovations be identified and how can the corresponding knowledge transfer occur?
- Publishing books about local innovation could enable knowledge sharing
- Farmer fairs provide quick and easy access to farmer innovation

Innovation triggers

- Innovation addressed challenges existing at community level as well as market opportunities
- The innovations respond directly to the local needs and utilise locally available resources
- Needs provoke invention, but a mechanism to upscale will help
- There is also a lot of social innovation to help with conflict resolution

Enabling environment (policy, funding etc)

- Questions:
 - ✓ Is market upscale important?
 - ✓ Does innovation have to bring financial return?
- How to support local innovators?
 - ✓ Need to protect farmers' intellectual property rights about their contribution to innovation
 - ✓ Recognise the process orientation to develop innovation
 - ✓ Technical + financial + market support is helpful
 - ✓ Policy/regulatory barriers to overcome for commercialisation and use of innovation in some countries

Annex 5: Messages from farmer innovators to the workshop participants

Farmer innovators from the four Eastern African countries were invited to give their ideas and suggestions about what the AISA participants should remember during their discussions and deliberations in the rest of the workshop (see Box 1).

They emphasised that the scientists should visit them in their fields to see what is actually happening and should not be in a hurry if they want to understand innovation by smallholder farmers. The farmers also pointed out that one key driver behind innovation is necessity. They invited scientists to work together with them in improving their innovations, which use mainly locally available materials, and they were optimistic that this approach to innovation could have a place in the development of agriculture in Africa.

Box 1: Excerpts from messages from the farmer innovators to the AISA workshop participants

Ethiopian farmer (man):

- What we farmers have observed is that there were some displays in English. Had the fair been connected to a field trip, it would have been very complete for the farmers. It might be good to bring farmers to rural environments to understand what people are doing and how people live.
- I am working on improving traditional beekeeping and ox-ploughs, using less wood to reduce deforestation. I inherited beekeeping from my father, who taught me a lot about it. For sharing among other Ethiopian farmers, this has been very useful. Our farmer innovation network is facilitating connections among ourselves. It would be good to work with an institution that creates linkages for wider networking beyond our locality.
- It's true that we get support but it's usually for a very short time. Experts only listen for a short time; they take a small part of our work and run away again. Since we lack support on a continuous basis, our innovation is lagging behind. Why don't you come for longer periods? Why don't you take more time to listen to us? If you take time to listen to and observe the behaviour of bees, you will see how bees are nesting out. Why are not people more patient?

Ugandan farmer (man):

- We're all innovators and our major objective is to live in the world as a habitable place. We have to leave the earth for our brothers, sisters, sons and daughters.
- We want to bridge the gap between researchers and farmers. Some farmers fear researchers because they want to protect their work. When farmers come here (to the EAFIF), they share their knowledge but they fear that their innovations could be taken away from them because they may not have funds (and education) to speed up innovation. We need to be protected and to address the gap.
- In Uganda, we have a bill of standards and farmers need money to present their innovations there but sometimes they can't afford this. We need to find ways to make sure people benefit from our innovations.
- Capacity building should be done in terms of inputs and finance. Sometimes finance is difficult to access – people push back when it comes to money. You people can support farmers.

Kenyan farmer (woman):

- The previous speakers have spoken a lot of what I wanted to say.
- The difficult issue is funding.
- I request that you document our innovations in the Web to reach more people.



Ethiopian farmer addresses AISA workshop participants (Photo: Fabian Odhiambo)

Annex 6: Details about hot topics for the Living Keynote

Hot Topic 1: Innovation drop zones? Dealing with interventions “parachuted” into situations without due appreciation of and embedding into local realities

Specific issues proposed by the AISA workshop organisers

- How and how well do innovation facilitation teams understand and balance the needs and demands of different actors, particularly local actors?
- To what extent do innovation interventions actually adapt to local contexts? What human and institutional capacities and financial resources are needed to do so? Who influences intervention choices and approaches?
- How can intervention teams/projects become aware how their actions may affect existing power relationships among local actors?

Further issues raised by the participants in plenary

- How to facilitate teams and power relations?
- These power dynamics often occur between researchers and local people: significant dialogue is required.

Hot Topic 2: Life under the hedge? Missing endogenous innovations that occur under the radar of innovation “experts”

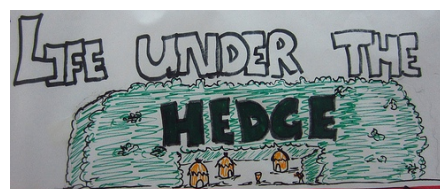

Specific issues proposed by the AISA workshop organisers

- What innovations to the “experts” miss? Innovations taking place outside the agricultural sector, innovations developed by marginalised groups, by groups who are in opposition to governments or national policies, by private firms attempting to protect their market – or simply by “ordinary” farmers with whom a project is working?
- Why can’t we see these hidden innovation processes? Who benefits from this situation? Who does not benefit from this situation?
- To what extent do “experts” recognise the contributions of individual innovators as opposed to those that result from more collective innovation processes?

Hot Topic 3. Follow the bright lights? Fitting current enthusiasms, e.g. for market-driven innovation, to all circumstances



Specific issues proposed by the AISA workshop organisers

- How and to what extent do such enthusiasms (or fads) endanger innovation?
- How do we make space and time to adjust to, understand and build capacities and skills for new innovation approaches?
- How can shorter-term “market” signals and pressures (of donors or policies) be balanced with the longer timelines needed to foster structural change?

Further issues raised by the participants in plenary

- What type of innovation are we talking about?

Hot Topic 4. Surf the wave? Balancing more directed and output-driven innovation projects with more opportunistic outcome-oriented innovation processes



- How can we integrate opportunistic innovation processes within output-driven innovation projects with fixed goals?
- How can local innovators be enabled to flexibly connect different short-term projects to realise a long-term ambition?

Hot Topic 5: Brain gain? Strengthening capacities to innovate and to facilitate innovation processes

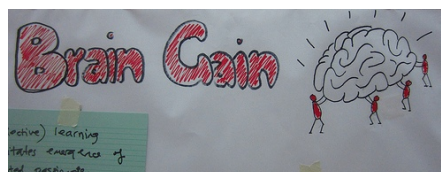

Specific issues proposed by the AISA workshop organisers

- How could universities and other training centres be associated with innovation processes and programmes?
- Who is best placed to support and facilitate innovation processes? What capacities are needed and do these vary depending on the type of innovation process?
- How can the capacities of the various actors involved in innovation be strengthened and by whom?
- Can multistakeholder innovation processes be steered and, if so, how? How do actors organise innovation through interaction? What interventions are possible if such processes cannot be managed?
- How do we develop adaptive capacities to manage innovation process crises: technical (lock-in), economic (risks, lack of funds etc) and social (tensions, power grabbing, political blockages etc)?

Further issues raised by the participants in plenary

- How to stimulate innovation approaches in research institutes?
- What about intellectual property rights?
-

Hot Topic 6: Suspended motion? Monitoring, evaluating, adjusting, learning and reflecting on innovation results, outcomes and impacts



Specific issues proposed by the AISA workshop organisers

- How can results, outcomes and impacts of innovation processes be assessed? Can qualitative dimensions be assessed scientifically?
- What are relevant time frames for assessing innovation processes?
- How can an innovation story reflect different and contradictory results, outcomes and impacts?
- How best to assess undesired or negative results, outcomes and impacts of innovation (exclusion, loss of resources, loss of traditional values promoting solidarity etc) and who should do this?

Further issues raised by the participants in plenary

- Include system scales and time horizons.
- How can existing documentation be used for learning and change?

- How to capture different types of impact?

Hot Topic 7: The ripple effect? Scaling innovation up and out



Issues raised by the participants in plenary

- How to scale up and out?
- How to disseminate findings?

Annex 7: Poster marketplace and Open Space session

Poster session

The short papers in these proceedings were presented at the workshop in the form of posters, shown at the “marketplace” in tents outside the meeting hall. Electronic versions of the posters can be downloaded from <http://aisa2013.wikispaces.com/ais+workshop>



Presentation of CCAFS Farms of the Future poster at the AISA workshop (Photo: Vivian Atakos)

Open Space discussions

The topics proposed and taken up by participants for Open Space discussions were:

1. Why are recommendations not being picked up? (or are they, but???)
2. From analysis to operation: putting AIS approach into practice
3. The role of fun in innovation systems (games, videos etc)
4. How to better link public/private advisory services with innovation systems?
5. What does it change to take an IS perspective for advisory services?
6. How to choose more cases to build evidence base convincing decision-makers?
7. Youth in AR4D and innovation systems in Africa
8. Gender and AIS
9. Innovation Platforms chat show



One of the Open Space discussions (Photo: Vivian Atakos)

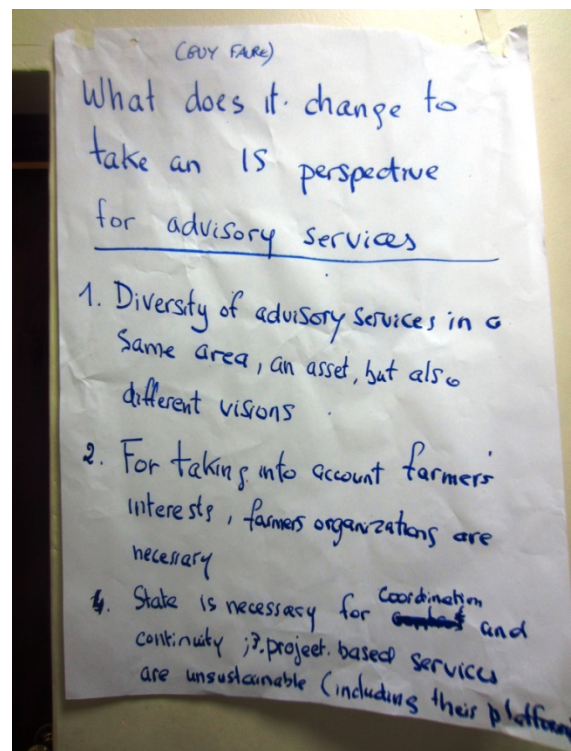
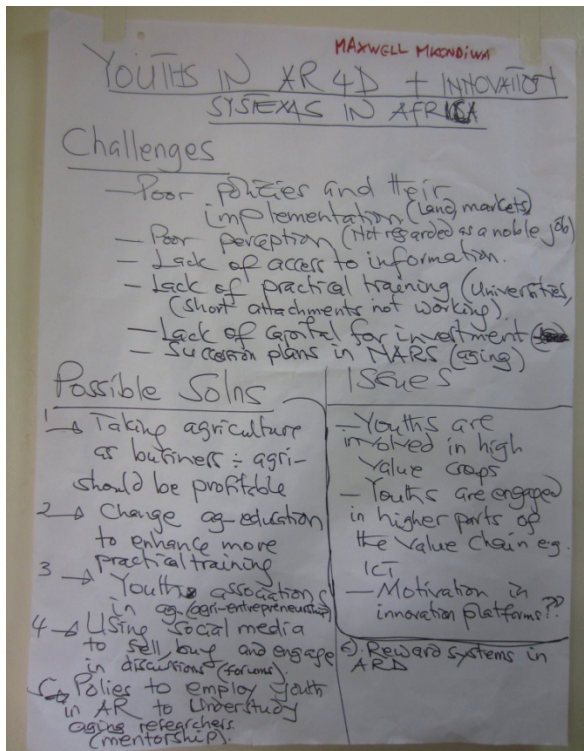

Examples of flipcharts from Open Space discussions (Photo: Ewen Le Borgne)

Annex 8: Feedback given by AISA workshop participants on the oral papers

The six longer papers (five of which are to be found in Section 2 of these proceedings) were presented orally during the AISA workshop in parallel sessions and gave rise to discussions in small groups. The edited output of these group discussions is summarised here and can help to reflect critically both on the content of each of the papers and on some of the issues tackled in the Living Keynote. It is advisable to read the papers before reading this section so as to be able to understand the context in which the discussion points below were raised.

Case 1: Assessing agricultural innovation experiences across Africa: the experience of JOLISAA (JOint Learning in Innovation Systems in African Agriculture)

How can we move from understanding innovation to supporting it?

This discussion was justified by the fact that, although the JOLISAA team dealt mainly with assessing innovation cases, it also tried to formulate (policy) recommendations for supporting innovation.

- Understanding of what and by whom?
 - What we should seek is shared understanding across actors; we need to find creative means of bringing people together
 - Innovation processes are all different, but is there a common way to look at them?
 - Earlier analysis of stakeholders in planning for better anticipation
 - Need to link more clearly concepts (AIS) to tangible practical issues
- Can we separate understanding innovation and supporting?
 - What types of understanding may serve to support innovation?
 - Understanding in itself can lead to change but...
 - Facilitation as catalyst of stakeholder dialogue on working through systemic blockage
 - Policy cannot address what is not understood
 - Understanding provides outline of processes, actors → investment/intervention opportunities
 - Identify triggers as leverage points for designing intervention/support
 - Strategic partners are needed that are specifically capable of linking understanding and support (e.g. research, brokers)
 - Integration of research's two roles: understanding and supporting via action research, which needs to be institutionalised in research, universities, extension, education curriculum)
 - Question: how to bring formal researchers to help local innovators?
- Markets as driver of innovation:
 - Importance for innovation of the link to markets
 - Support innovation by adding more value to parts of the products (quality improvement, labels, trade)
 - Researchers should provide evidence that innovators need support for trademark, label and registering for protection of rights
- Innovation and innovation platforms (see also innovation platform discussion notes):
 - What kinds of platforms may spur recognition of local innovation?
 - Champions in platforms should be capacitated to identify relevant stakeholders taking in charge new challenges popping up in the process; some can address policymakers, others can approach traders; in parallel, stakeholders should come together in the platform
 - Stakeholder platforms necessary at different levels; they have to be connected; few existing platforms at practitioner ("lower") level; also link with communal governmental bodies
 - Empower local-level platforms for local stakeholders to have a voice?
 - How do you build capacity at the various levels where platforms are needed?
 - Legitimacy of the different stakeholders' representatives? What to do when stakeholders are not organised? How to involve the private sector when there is no trust? – lengthy process; trust → partnership

- Entering with a project framework is contradictory with the development of a partnership
- If there is too strong/dominant a stakeholder (state, big man), platforms cannot work properly
- Policy / policy formulation / policy support:
 - Rural stakeholders have no high-level body to engage with donors, international funds (such as carbon finance); the issues in institutional arrangements are the adequacy of benefits, access to benefits, distribution of benefits
 - Innovation is already on the political agenda, but what about power?
 - Projects/interventions are not open enough to look at what is happening beyond what was intended
 - We should present the evidence-based results for decision-makers to take action
 - We should enlarge the evidence base to more cases in order to be convincing
 - Policy formulation and application are motivated by success and access to credit
- Miscellaneous issues raised:
 - Flexible resources are needed to respond to evolving circumstances
 - To increase innovation capacity, introduction of principles rather than products is needed
 - Need for continuous, iterative reflection and learning at micro- and macroscale embedded in the innovation process among farmers, stakeholders, with policy buy-in
 - We need clear criteria to know what kinds of innovation to support.

How does the JOLISAA work relate to the seven Hot Issues?

Are these JOLISAA policy recommendations really new? Many of the recommendations made, not only JOLISAA's, are repetitious. Is there power in repetition? The repetitions are not really being picked up. Why would that be? Because they are really difficult to operationalise (sustainably; see below). The interaction with the complex context of smallholder farmers is one explanation for difficulties in operationalisation, particularly when it comes to M&E. And here the Hot Issue of "Suspended action" comes in. Added to this is the context of the intervening agent, which is quite different and, in many cases, these two contexts do not easily come together; this leads to clashes. Also, the complexity of the processes makes it difficult to support them. However, there are windows: opportunities at certain moments in which such support can be given. In response to this, it was suggested that such rather eclectic support to ongoing innovation is not enough for Africa. Other, more planned and targeted forms of support with a wider vision to development of countries, economies etc are needed. These two types of support are not exclusive; both are needed!

Another spinoff from this question was: If these recommendations are not picked up, can we not come up with other, better recommendations?

Recommendations are not being picked up, and approaches are difficult to operationalise

This situation needs attention: What is going wrong here?! Is the approach wrong? Or is the targeted audience not getting it?

However, we should not stick with the impression that nothing is happening: there are initiatives that pick up on the recommendations and operationalise them. Are these initiative not successful then? Why do they fail or not catch the attention merited?

Another possible explanation has to do with the fact there is not enough learning. Or maybe there is learning but not by the right people. A lesson on learning is missing in the JOLISAA recommendations! Link with Hot Issue 6: M&E tends to be too oriented to output and not process.

Two more reactions:

- The context is not always that complex and does not always concern innovation bundles as a whole: it depends on the nature of the innovation.
- Projects are planned, but the success is not always in the area planned (falling outside the view of the project).

Case 2: Local innovation funds: the experience of PROLINNOVA (Promoting Local Innovation in ecologically oriented agriculture and NRM)

Integrating Local Innovation Support Funds (LISFs) into formal ARD

- Group innovation takes place around different challenges – fund needed to support this process and bring in researchers sharing this issue.
- Who does the validation of local innovation: farmers & scientists + publish the findings: joint effort + suggest improvements.
- Research as source of expertise into the local innovation process.
- Documentation by both farmers + researchers: local knowledge and scientific knowledge integrated in “language” of researchers and of farmers → allows spreading.
- Get funders and media into the Local Steering Committees for LISF for implementation processes (TV, newspapers etc) → pull interest of researchers, also to access research funds.
- Intellectual property rights (IPRs): there is a need to have discussion + agreement to share the innovations + results of experimentation; most agricultural innovations not patentable – important to acknowledge source of innovation.
- Farmers should control part of ARD funds (research institutes taking over role of PROLINNOVA).
- Is it important to formalise the farmer-led innovation process? Role of M&E
 - Wider benefits – easier to scale out
 - More acceptability + ownership by more farmers
 - As farmers get recognised → more innovation emerges
 - Formal research impact on local innovation minimal – research needs effective way to scale out
 - Helps to spread also formal ARD results
- All stakeholders should be engaged in (local) innovation processes e.g. through innovation platforms; innovation by farmers can benefit others.
- LISFs should be part of any local initiative/project, not a stand-alone approach.
- Generate better evidence-based arguments to show that this approach leads to something better than what is currently done in ARD.

How does PROLINNOVA work relate to the seven Hot Issues?

- Under the hedge issue: identifying innovators who are not visible.
- Opposite of parachuting: bottom-up approach (selection process?)
- Engage stakeholders to ensure “support”, sustainability, up- and outscaling.
- Process documentation: measuring impact, sharing the experiences.
- How to facilitate farmer-to-farmer interactions.
- There is a mismatch between (private sector) scientists' incentives and the needs of the farmer: how do we address this?
- Brain gain: Potential to attract youth back to agriculture (digital generation).
- Process akin to business incubation (move it forward or linkage to other organisations).
- Strengthen Local Steering Committees to perform M&E (or use students?).
- Bright lights not necessarily bad – rebrand and improve them.

Case 3: Facilitating institutional change in West Africa, by CoS–SIS (Convergence of Sciences: Strengthening Innovation Systems)

- How do we define scaling up?
- Mainstreaming CoS–SIS concept in institutions.
- How do we share lessons learnt in other platforms?
- How to deal with challenges?

- Visions of the programme scaling up.
- Innovation processes related to institutional constraints.
- Identified champions could be the conveyors of the platform.
- Convince policymakers to push it into government agenda.
- Agricultural research in agricultural business?
- Building synergy with other innovations.
- Approach to mobilise resources.

Case 4: Delivering Impact from agricultural research and development: the case of Sub-Saharan Africa Challenge Programme, by FARA (Forum on Agricultural Research in Africa)

- Do we tend to implement platforms for platforms' sake?
- "Platform" is usefully vague, but it actually depends on who takes part in it.
- Is IARD democratic? It can be a tool for control?
- Will donors fund diversity? There is no panacea.
- Surf the wave: CRP formation process – proof of concept? approach?
- Brain gain: Evaluation frame drives programme. Evidence doesn't change practice but relations, network, championing do. How do innovation platforms facilitate capacity building? Soft skills training for all participants.
- Suspended motion: Continental or national M&E? Output M&E but not outcome? Institutional form, but content?
- Scaling: start with institutional infrastructure, not technical, modelling...

Case 5: Learning from agricultural research for development programmes in sub-Saharan Africa, by AusAID / CSIRO Ecosystem Sciences

No notes made available, sorry!

Case 6: Innovation Platform (IP) Writeshop ILRI / CPWF (Challenge Program on Water and Food)

- Why IPs? Because we want to address the full value chain. But this is not always a good justification.
- If things are not working, or if the innovation system works relatively well: then IP possibly not an answer.
- Are there other tools/approaches than IPs? Can we build on "something" that already exists?
 - Other models: existing structures, e.g. national associations.
 - Many approaches but not all are innovation platforms.
 - Other models? depends on aim; IPs may make things go faster, upscaling but decision-making slow?
- What types of IP are needed? What is the problem or challenge faced: policy? technical?
- Different types of stakeholders needed to make the innovation system work. Because problems are complex, different types of role of players e.g. production, market
 - Main issue is actors talking to each other/linkages
 - Role of private sector: involve it when appropriate
 - Actors looking for solutions of problems (not innovation) often strongly producer-focused
 - Risk of constitution/rules/exclusion
 - Organisations (brokers) to link? Does not happen by itself → intervention; beware that a process not properly facilitated can end up causing real problems
- What is the right topic an IP should focus on? What are relevant actors? Start with something that contributes to development. Stakeholder analysis (iterative process based on interest), strong action research.

- If addressed, no external intervention is needed.
- Need for a typology of IP of different kinds?
- How to get an IP functioning properly?
 - Needs purpose and who to involve needs proper situation analysis.
 - Common interest, diagnosis, problem-solving, inclusive, open and with potential benefits.
 - Never reach perfection; can always improve; shouldn't stop innovating; members change and evolve; innovation process can continue.
 - Who triggers? Can be anyone! Requires champion.
 - Innovation process vs products
 - Avoid feeling of dependency? But this may not always be perceived similarly by different stakeholders!



Platform legitimacy of the different stakeholders represented... what do when stakeholders are not organized? how to make people enter when there is no trust... long process.

Platform legitimacy is understanding and the type of a partnership.

If there is a leading dominant SH (State, system) platform cannot work.

most stakeholders have an explicit need to engage with about educational level (can be 1 farmer). The other is institutional component... → sharing of benefit, access to benefit of distribution of benefit.

Flipcharts produced during the discussion of innovation platforms (Photo: Ewen Le Borgne)

Annex 9: Notes from closing evaluation with the AISA workshop participants

What was liked:

- Energy
- Interaction and tone and collegiality, learning, open
- Good choice of participants
- Facilitation
- Living Keynote
- Group discussions
- Messages for audiences
- Lunch
- Lots of walking

What could be better next time:

- Too many facilitation procedures – confusing?
- Choosing between the oral presentations – could have been presented sequentially in plenary
- Group forming not well enough managed?
- Poster time too short (posters should have been displayed since Day 1, in a place where participants can go and look at them at their leisure)
- Better capture the audience's messages on PPT
- More use of PPT for group reporting
- Lots of walking* (good & bad!)